Evolution

METROPOLIS
Restyling 2021

LISTINO PREZZI (I.V.A. ESCLUSA) • PRICE LIST
ITALIANO/ ENGLISH



STOSA
CUCINE

Metropolis

SPESSORE ANTA
DOOR THICKNESS
23 mm

ALTEZZA BASE
BASE HEIGHT
H 78 cm

ALTEZZA BASE
BASE HEIGHT
H 81 cm
CON GOLA -
LINEAR - GRIP
WITH GROOVE -
LINEAR - GRIP



CARATTERISTICHE / FEATURES

Anta in Termo Strutturato - Laminato Materico, bordo ABS in tinta su 4 lati.
Anta in mdf rivestita Pet con retro melaminico in colore anta, bordo ABS in tinta su 4 lati.
Anta in Fenix, bordo ABS in tinta su 4 lati.
Anta rifilabile.
Thermo textured door - Textured laminate, matching ABS edge on 4 sides.
Pet finished MDF door with door color melamine back, matching ABS edge on 4 sides.
Fenix finished chipboard door, matching ABS edge on 4 sides.
Door trimmable.

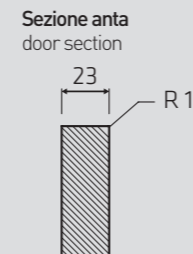

STRUTTURE CARCASSES



Scocca Rosè
Interno Rosè
DI SERIE

Rosè carcass
Rosè interior
STANDARD



Scocca Vulcan
Interno Vulcan
A RICHIESTA

Vulcan carcass
Vulcan interior
ON DEMAND



Scocca White
Interno White
A RICHIESTA

White carcass
White interior
ON DEMAND

Fianchi di finitura nei colori anta :
a richiesta con maggiorazione di prezzo
(BIFACCIALI: faccia esterna, faccia interna e bordi in tutti i colori
delle ante)

finishing sides in the door colors :
on demand with price surcharge
(DOUBLE-FACE: outside, inside and edges available with all door
colours)

VEDI TUTTE LE FINITURE ALLA SEZIONE FIANCHI
SEE ALL FINISHES IN THE SIDES SECTION

TIPOLOGIE ANTA DOOR TYPES

Anta piena
Termo Strutturato
Thermo Structured
full door



Anta piena
Laminato Materico
Textured Laminate
full door



Anta piena
Pet
Pet
full door



Anta piena
Fenix
Fenix
full door



TIPO 1
TYPE 1
Telaio alluminio
NERO SPAZZOLATO- TITANIO
con Vetro Grigio semitrasparente
BRUSHED BLACK - TITANIUM
Aluminium frame with Glass
Grey semitransparent



TIPO 2
TYPE 2
Telaio alluminio
NERO SPAZZOLATO- TITANIO
con Vetro Cannelato semitrasparente
BRUSHED BLACK - TITANIUM
Aluminium frame with Glass
Ribbed semitransparent



ANTA VETRO ABBINATA (ALIANI) COMBINED GLASS DOOR (ALIANI)

Telaio Titanio opaco e Vetro
Matt Titanium Frame and Glass



Tipologia vetro
Glass types



Vetro lucido
(di serie)
STANDARD
Glossy glass
(standard)

Per i colori del vetro lucido
vedi vetri FASCIA A
For glossy glass colors see
colors of RANGE A

SISTEMI DI APERTURA OPENING SYSTEMS



DI SERIE
STANDARD

BLADE MRUB
Maniglia Nero Opaco
Interasse 96-160-320mm
BLADE MRUB
Matt Black handle
Drilling centre 96-160-320 mm



Gola Scavata
Dug Groove



Gola Piatta
Flat Groove

VEDI TUTTE LE FINITURE ALLE SEZIONI MANIGLIE, GOLA SCAVATA, GOLA PIATTA
SEE ALL THE FINISHES AT THE HANDLES, DUG GROOVE, FLAT GROOVE SECTION

Finiture e colori disponibili

Available finishes and colors

TIPOLOGIA MATERIALE MATERIAL TYPES

TERMO STRUTTURATO
THERMO STRUCTURED

Colori in pronta consegna
Available colours

COLORI ANTE DOORS COLORS



LAMINATO MATERICO
TEXTURED LAMINATE

Colori in pronta consegna
Available colours

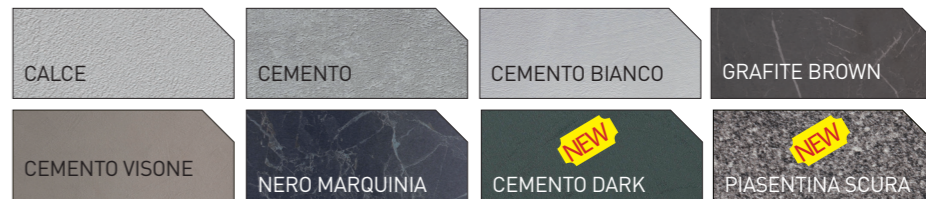

PET
PET

Colori in pronta consegna
Available colours



TERMO STRUTTURATO
THERMO STRUCTURED

Colori in pronta consegna
Available colours



FENIX
FENIX

Tempi di consegna n° 5
settimane dalla conferma
dell'ordine
For on-demand colours, the
delivery time is 5 weeks from
the order confirmation



MENSOLE SHELVES

Mensole Laminato Rosè, Vulcan,
White (colore scocca)
Shelves Rosè, Vulcan, White
Laminate (carcass colour)

Mensole Termo Strutturato
(per colori: Termo Strutturato)
Shelves Thermo Structured
(for colors: Thermo Structured)

Mensole Pet
(per colori: Pet)
Shelves Pet
(for colors: Pet)

Mensole Fenix
(per colori: Fenix)
Shelves Fenix
(for colors: Fenix)

Mensole Laminato Materico
(per colori: Laminato Materico)
Shelves Textured Laminate
(for colors: Textured Laminate)

VEDI TUTTE LE FINITURE ALLA SEZIONE MENSOLE
SEE ALL FINISHES IN THE SHELVES SECTION

SCHEMA DI PREZZATURA PENSILE CON VANO A GIORNO LATERALE
PRICE LABELING SCHEME WALL UNIT WITH SIDE OPEN COMPARTMENT

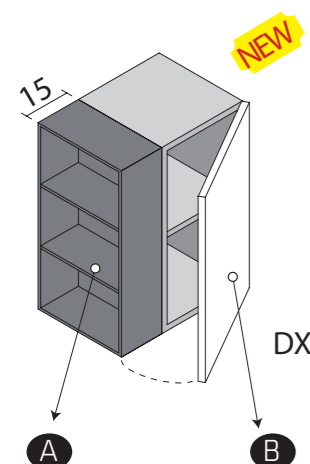

Pensile con vano a giorno laterale disponibile sia DX che SX composto sempre da n° 2 elementi distinti agganciati tra di loro:

elemento **A** ELEMENTO A GIORNO "L10" / VANO A GIORNO IN METALLO "L10"

(per colorazioni disponibili consultare pag. 210-211-218)

+

elemento **B** SCOCCA NOBILITATO con anta da 45 - 60 - 75 cm

Il metodo di prezzatura dell'intera struttura avviene pertanto sommando all'elemento **A** (ELEMENTO A GIORNO "L10" / VANO A GIORNO IN METALLO), l'elemento **B** (PENSILE CON ANTA)

Wall unit with side open compartment available in both DX and SX always composed by 2 distinct elements snap to one another :

element **A** "L10" OPEN ELEMENT / "L10" METAL OPEN COMPARTMENT

(for available colors consult p. 210-211-218)

+

element **B** MELAMINE CARCASS with door Trapezoid w. 45 - 60 - 75 cm

The pricing method of entire structure is therefore performed by summing element **A** ("L10" OPEN ELEMENT / "L10" METAL OPEN COMPARTMENT), element **B** (WALL UNIT WITH DOOR)

STRUTTURA STRUCTURE	DESCRIZIONE DESCRIPTION	H.(cm) H.(cm)	PR.(cm) D.(cm)	L.(cm) W.(cm)	CODICE CODE	E1	E2	E4
------------------------	----------------------------	------------------	-------------------	------------------	----------------	----	----	----

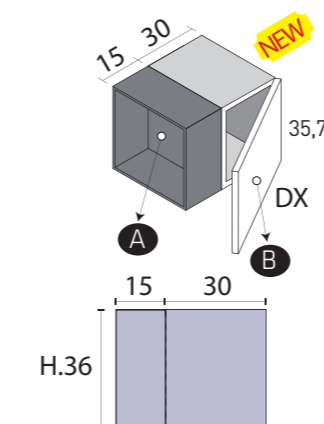

**PENSILE 1 ANTA
CON VANO A GIORNO LATERALE**

Composto da:

- vano a giorno in metallo "L10" **A**
- scocca nobilitato con anta L. 44,7 cm **B**

WALL UNIT 1 DOOR
WITH SIDE OPEN COMPARTMENT

Composed of:

- "L10" metal open compartment **A**
- melamine carcass with door W. 44,7 cm **B**

VANO A GIORNO IN METALLO "L10" VERSIONE LACCATO OPACO	36	34	15	TL34000	212	212	212
"L10" METAL OPEN COMPARTMENT VERSION MATT LACQUERED	36	34	30	PR30B00	90	94	105
Totale A+B	302	306	317				

**PENSILE 1 ANTA
CON VANO A GIORNO LATERALE**

Composto da:

- elemento a giorno "L10" **A**
- scocca nobilitato con anta L. 44,7 cm **B**

WALL UNIT 1 DOOR
WITH SIDE OPEN COMPARTMENT

Composed of:

- "L10" open compartment **A**
- melamine carcass with door W. 44,7 cm **B**

ELEMENTO A GIORNO "L10" VERSIONE LACCATO OPACO	36	34	15	TL34000	264	264	264
"L10" OPEN ELEMENT VERSION MATT LACQUERED	36	34	30	PR30B00	90	94	105
Totale A+B	354	358	369				

ELEMENTO A GIORNO "L10" VERSIONE TERMO STRUTTURATO - LAMINATO MATERICO - NOBILITATO	36	34	15	TL34000	197	197	197
"L10" OPEN ELEMENT VERSION THERMO TEXTURED - TEXTURED LAMINATE - MELAMINE	36	34	30	PR30B00	90	94	105
Totale A+B	287	291	302				



Per colorazioni disponibili per ELEMENTI A GIORNO "L10" e VANI A GIORNO IN METALLO vedi pg. 210-211-218
For colors available for "L10" OPEN ELEMENT and METAL OPEN COMPARTMENT see pg. 210-211-218

METROPOLIS

ELEMENTI CARATTERIZZANTI

CHARACTERISTIC ELEMENTS

EVOLUTION 2021

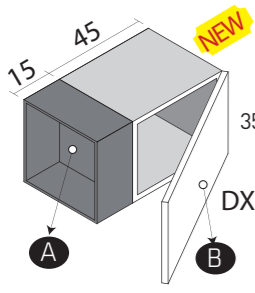
STRUTTURA STRUCTURE	DESCRIZIONE DESCRIPTION	H.(cm) H.(cm)	PR.(cm) D.(cm)	L.(cm) W.(cm)	CODICE CODE	E1	E2	E4
 <p>PENSILE 1 ANTA CON VANO A GIORNO LATERALE, Composto da: - vano a giorno in metallo "L10" A - scocca nobilitata con anta L. 59,7 cm B</p> <p>WALL UNIT 1 DOOR WITH SIDE OPEN COMPARTMENT Composed of: - "L10" metal open compartment A - melamine carcass with door W. 59,7 cm B</p>	VANO A GIORNO IN METALLO "L10" VERSIONE LACCATO OPACO	36	34	15	TL34000	212	212	212
	"L10" METAL OPEN COMPARTMENT VERSION MATT LACQUERED	36	34	45	PR45B01	100	105	120
	Totale A+B					312	317	332

<p>PENSILE 1 ANTA CON VANO A GIORNO LATERALE, Composto da: - elemento a giorno "L10" A - scocca nobilitata con anta L. 59,7 cm B</p> <p>WALL UNIT 1 DOOR WITH SIDE OPEN COMPARTMENT Composed of: - "L10" open compartment A - melamine carcass with door W. 59,7 cm B</p>	ELEMENTO A GIORNO "L10" VERSIONE LACCATO OPACO	36	34	15	TL34000	264	264	264
	"L10" OPEN ELEMENT VERSION MATT LACQUERED	36	34	45	PR45B01	100	105	120
	Totale A+B					364	369	384
<p>ELEMENTO A GIORNO "L10" VERSIONE TERMO STRUTTURATO - LAMINATO MATERICO - NOBILITATO "L10" OPEN ELEMENT VERSION THERMO TEXTURED - TEXTURED LAMINATE - MELAMINE</p>		36	34	15	TL34000	197	197	197
		36	34	45	PR45B01	100	105	120
	Totale A+B					297	302	317



METROPOLIS

ELEMENTI CARATTERIZZANTI

CHARACTERISTIC ELEMENTS

EVOLUTION 2021

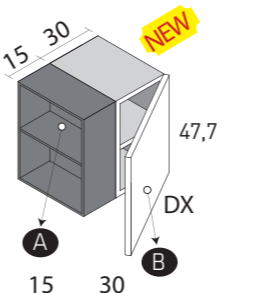
STRUTTURA STRUCTURE	DESCRIZIONE DESCRIPTION	H.(cm) H.(cm)	PR.(cm) D.(cm)	L.(cm) W.(cm)	CODICE CODE	E1	E2	E4
 <p>PENSILE 1 ANTA, 1 ripiano CON VANO A GIORNO LATERALE Composto da: - vano a giorno in metallo "L10" A - scocca nobilitata con anta L. 44,7 cm B</p> <p>WALL UNIT 1 DOOR, 1 shelf WITH SIDE OPEN COMPARTMENT Composed of: - "L10" metal open compartment A - melamine carcass with door W. 44,7 cm B</p>	VANO A GIORNO IN METALLO "L10" VERSIONE LACCATO OPACO	48	34	15	TL34002	244	244	244
	"L10" METAL OPEN COMPARTMENT VERSION MATT LACQUERED	48	34	30	PR30D00	95	99	116
	Totale A+B					339	343	360

<p>PENSILE 1 ANTA, 1 ripiano CON VANO A GIORNO LATERALE Composto da: - elemento a giorno "L10" A - scocca nobilitata con anta L. 44,7 cm B</p> <p>WALL UNIT 1 DOOR, 1 shelf WITH SIDE OPEN COMPARTMENT Composed of: - "L10" open compartment A - melamine carcass with door W. 44,7 cm B</p>	ELEMENTO A GIORNO "L10" VERSIONE LACCATO OPACO	48	34	15	TL34002	305	305	305
	"L10" OPEN ELEMENT VERSION MATT LACQUERED	48	34	30	PR30D00	95	99	116
	Totale A+B					400	404	421
<p>ELEMENTO A GIORNO "L10" VERSIONE TERMO STRUTTURATO - LAMINATO MATERICO - NOBILITATO "L10" OPEN ELEMENT VERSION THERMO TEXTURED - TEXTURED LAMINATE - MELAMINE</p>		48	34	15	TL34002	223	223	223
		48	34	30	PR30D00	95	99	116
	Totale A+B					318	322	339



Per colorazioni disponibili per ELEMENTI A GIORNO "L10" e VANI A GIORNO IN METALLO vedi pg. 210-211-218
For colors available for "L10" OPEN ELEMENT and METAL OPEN COMPARTMENT see pg. 210-211-218



Per colorazioni disponibili per ELEMENTI A GIORNO "L10" e VANI A GIORNO IN METALLO vedi pg. 210-211-218
For colors available for "L10" OPEN ELEMENT and METAL OPEN COMPARTMENT see pg. 210-211-218

METROPOLIS

ELEMENTI CARATTERIZZANTI

CHARACTERISTIC ELEMENTS

EVOLUTION 2021

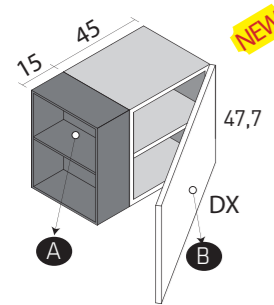
STRUTTURA STRUCTURE	DESCRIZIONE DESCRIPTION	H.(cm) H.(cm)	PR.(cm) D.(cm)	L.(cm) W.(cm)	CODICE CODE	E1	E2	E4
 <p>PENSILE 1 ANTA, 1 ripiano CON VANO A GIORNO LATERALE, Composto da: - vano a giorno in metallo "L10" A - scocca nobilitato con anta L. 59,7 cm B</p> <p>WALL UNIT 1 DOOR, 1 shelf WITH SIDE OPEN COMPARTMENT Composed of: - "L10" metal open compartment A - melamine carcass with door W. 59,7 cm B</p>	VANO A GIORNO IN METALLO "L10" VERSIONE LACCATO OPACO	48	34	15	TL34002	244	244	244
	"L10" METAL OPEN COMPARTMENT VERSION MATT LACQUERED	48	34	45	PR45D01	110	114	131
	Totale A+B	354	358	375				

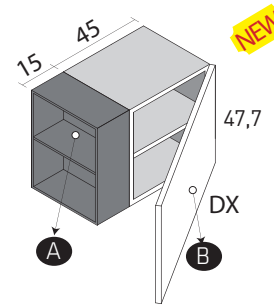
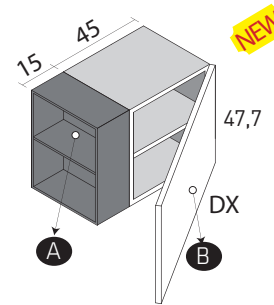
 <p>PENSILE 1 ANTA, 1 ripiano CON VANO A GIORNO LATERALE, Composto da: - elemento a giorno "L10" A - scocca nobilitato con anta L. 59,7 cm B</p> <p>WALL UNIT 1 DOOR, 1 shelf WITH SIDE OPEN COMPARTMENT Composed of: - "L10" open compartment A - melamine carcass with door W. 59,7 cm B</p>	ELEMENTO A GIORNO "L10" VERSIONE LACCATO OPACO	48	34	15	TL34002	305	305	305
	"L10" OPEN ELEMENT VERSION MATT LACQUERED	48	34	45	PR45D01	110	114	131
	Totale A+B	415	419	436				
 <p>PENSILE 1 ANTA, 1 ripiano CON VANO A GIORNO LATERALE, Composto da: - elemento a giorno "L10" A - scocca nobilitato con anta L. 59,7 cm B</p> <p>WALL UNIT 1 DOOR, 1 shelf WITH SIDE OPEN COMPARTMENT Composed of: - "L10" open compartment A - melamine carcass with door W. 59,7 cm B</p>	ELEMENTO A GIORNO "L10" VERSIONE TERMO STRUTTURATO - LAMINATO MATERICO - NOBILITATO	48	34	15	TL34002	223	223	223
	"L10" OPEN ELEMENT VERSION THERMO TEXTURED - TEXTURED LAMINATE - MELAMINE	48	34	45	PR45D01	110	114	131
	Totale A+B	333	337	354				



METROPOLIS

ELEMENTI CARATTERIZZANTI

CHARACTERISTIC ELEMENTS

EVOLUTION 2021

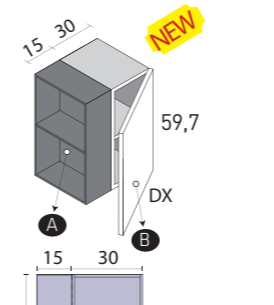
STRUTTURA STRUCTURE	DESCRIZIONE DESCRIPTION	H.(cm) H.(cm)	PR.(cm) D.(cm)	L.(cm) W.(cm)	CODICE CODE	E1	E2	E4
 <p>PENSILE 1 ANTA, 1 ripiano CON VANO A GIORNO LATERALE Composto da: - vano a giorno in metallo "L10" A - scocca nobilitato con anta L. 44,7 cm B</p> <p>WALL UNIT 1 DOOR, 1 shelf WITH SIDE OPEN COMPARTMENT Composed of: - "L10" metal open compartment A - melamine carcass with door W. 44,7 cm B</p>	VANO A GIORNO IN METALLO "L10" VERSIONE LACCATO OPACO	60	34	15	TL34004	308	308	308
	"L10" METAL OPEN COMPARTMENT VERSION MATT LACQUERED	60	34	30	PR30F00	104	108	128
	Totale A+B	412	416	436				

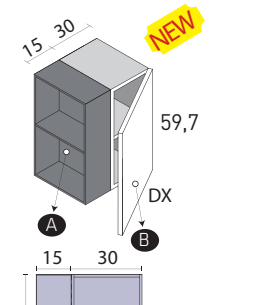
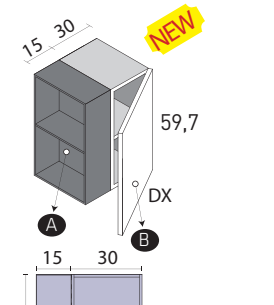
 <p>PENSILE 1 ANTA, 1 ripiano CON VANO A GIORNO LATERALE Composto da: - elemento a giorno "L10" A - scocca nobilitato con anta L. 44,7 cm B</p> <p>WALL UNIT 1 DOOR, 1 shelf WITH SIDE OPEN COMPARTMENT Composed of: - "L10" open compartment A - melamine carcass with door W. 44,7 cm B</p>	ELEMENTO A GIORNO "L10" VERSIONE LACCATO OPACO	60	34	15	TL34004	385	385	385
	"L10" OPEN ELEMENT VERSION MATT LACQUERED	60	34	30	PR30F00	104	108	128
	Totale A+B	489	493	513				
 <p>PENSILE 1 ANTA, 1 ripiano CON VANO A GIORNO LATERALE Composto da: - elemento a giorno "L10" A - scocca nobilitato con anta L. 44,7 cm B</p> <p>WALL UNIT 1 DOOR, 1 shelf WITH SIDE OPEN COMPARTMENT Composed of: - "L10" open compartment A - melamine carcass with door W. 44,7 cm B</p>	ELEMENTO A GIORNO "L10" VERSIONE TERMO STRUTTURATO - LAMINATO MATERICO - NOBILITATO	60	34	15	TL34004	235	235	235
	"L10" OPEN ELEMENT VERSION THERMO TEXTURED - TEXTURED LAMINATE - MELAMINE	60	34	30	PR30F00	104	108	128
	Totale A+B	339	343	363				



Per colorazioni disponibili per ELEMENTI A GIORNO "L10" e VANI A GIORNO IN METALLO vedi pg. 210-211-218
For colors available for "L10" OPEN ELEMENT and METAL OPEN COMPARTMENT see pg. 210-211-218



Per colorazioni disponibili per ELEMENTI A GIORNO "L10" e VANI A GIORNO IN METALLO vedi pg. 210-211-218
For colors available for "L10" OPEN ELEMENT and METAL OPEN COMPARTMENT see pg. 210-211-218

METROPOLIS

ELEMENTI CARATTERIZZANTI

CHARACTERISTIC ELEMENTS

EVOLUTION 2021

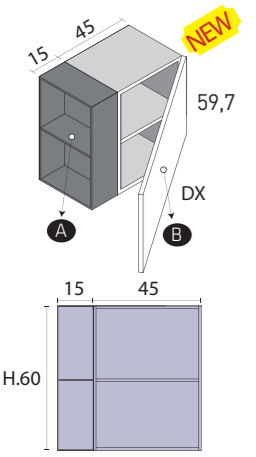
STRUTTURA STRUCTURE	DESCRIZIONE DESCRIPTION	H.(cm) H.(cm)	PR.(cm) D.(cm)	L.(cm) W.(cm)	CODICE CODE	E1	E2	E4
	PENSILE 1 ANTA, 1 ripiano CON VANO A GIORNO LATERALE, Composto da: - vano a giorno in metallo "L10" A - scocca nobilitato con anta L. 59,7 cm B WALL UNIT 1 DOOR, 1 shelf WITH SIDE OPEN COMPARTMENT Composed of: - "L10" metal open compartment A - melamine carcass with door W. 59,7 cm B							
	VANO A GIORNO IN METALLO "L10" VERSIONE LACCATO OPACO "L10" METAL OPEN COMPARTMENT VERSION MATT LACQUERED	60	34	15	TL34004	308	308	308
		60	34	45	PR45F02	120	129	146
	Totale A+B				428	437	454	

**PENSILE 1 ANTA, 1 ripiano
CON VANO A GIORNO LATERALE,**
 Composto da:
 - elemento a giorno "L10" **A**
 - scocca nobilitato con anta L. 59,7 cm **B**
 WALL UNIT 1 DOOR, 1 shelf
 WITH SIDE OPEN COMPARTMENT
 Composed of:
 - "L10" open compartment **A**
 - melamine carcass with door W. 59,7 cm **B**

ELEMENTO A GIORNO "L10" VERSIONE LACCATO OPACO "L10" OPEN ELEMENT VERSION MATT LACQUERED	60	34	15	TL34004	385	385	385
	60	34	45	PR45F02	120	129	146
Totale A+B					505	514	531
ELEMENTO A GIORNO "L10" VERSIONE TERMO STRUTTURATO - LAMINATO MATERICO - NOBILITATO "L10" OPEN ELEMENT VERSION THERMO TEXTURED - TEXTURED LAMINATE - MELAMINE	60	34	15	TL34004	235	235	235
	60	34	45	PR45F02	120	129	146
Totale A+B					355	364	381



METROPOLIS

ELEMENTI CARATTERIZZANTI

CHARACTERISTIC ELEMENTS

EVOLUTION 2021

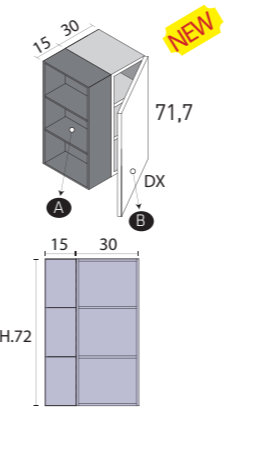
STRUTTURA STRUCTURE	DESCRIZIONE DESCRIPTION	H.(cm) H.(cm)	PR.(cm) D.(cm)	L.(cm) W.(cm)	CODICE CODE	E1	E2	E4
	PENSILE 1 ANTA, 1 ripiano CON VANO A GIORNO LATERALE Composto da: - vano a giorno in metallo "L10" A - scocca nobilitato con anta L. 44,7 cm B WALL UNIT 1 DOOR, 1 shelf WITH SIDE OPEN COMPARTMENT Composed of: - "L10" metal open compartment A - melamine carcass with door W. 44,7 cm B							
	VANO A GIORNO IN METALLO "L10" VERSIONE LACCATO OPACO "L10" METAL OPEN COMPARTMENT VERSION MATT LACQUERED	72	34	15	TL34006	349	349	349
		72	34	30	PR30H01	113	118	141
	Totale A+B				462	467	490	

**PENSILE 1 ANTA, 1 ripiano
CON VANO A GIORNO LATERALE**
 Composto da:
 - elemento a giorno "L10" **A**
 - scocca nobilitato con anta L. 44,7 cm **B**
 WALL UNIT 1 DOOR, 1 shelf
 WITH SIDE OPEN COMPARTMENT
 Composed of:
 - "L10" open compartment **A**
 - melamine carcass with door W. 44,7 cm **B**

ELEMENTO A GIORNO "L10" VERSIONE LACCATO OPACO "L10" OPEN ELEMENT VERSION MATT LACQUERED	72	34	15	TL34006	436	436	436
	72	34	30	PR30H01	113	118	141
Totale A+B					549	554	577
ELEMENTO A GIORNO "L10" VERSIONE TERMO STRUTTURATO - LAMINATO MATERICO - NOBILITATO "L10" OPEN ELEMENT VERSION THERMO TEXTURED - TEXTURED LAMINATE - MELAMINE	72	34	15	TL34006	260	260	260
	72	34	30	PR30H01	113	118	141
Totale A+B					373	378	401



Per colorazioni disponibili per ELEMENTI A GIORNO "L10" e VANI A GIORNO IN METALLO vedi pg. 210-211-218
 For colors available for "L10" OPEN ELEMENT and METAL OPEN COMPARTMENT see pg. 210-211-218



Per colorazioni disponibili per ELEMENTI A GIORNO "L10" e VANI A GIORNO IN METALLO vedi pg. 210-211-218
 For colors available for "L10" OPEN ELEMENT and METAL OPEN COMPARTMENT see pg. 210-211-218

METROPOLIS

ELEMENTI CARATTERIZZANTI

CHARACTERISTIC ELEMENTS

EVOLUTION 2021

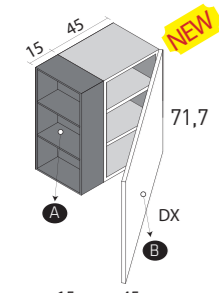
STRUTTURA STRUCTURE	DESCRIZIONE DESCRIPTION	H.(cm) H.(cm)	PR.(cm) D.(cm)	L.(cm) W.(cm)	CODICE CODE	E1	E2	E4
	PENSILE 1 ANTA, 1 ripiano CON VANO A GIORNO LATERALE, Composto da: - vano a giorno in metallo "L10" A - scocca nobilitato con anta L.59,7 cm B WALL UNIT 1 DOOR, 1 shelf WITH SIDE OPEN COMPARTMENT Composed of: - "L10" metal open compartment A - melamine carcass with door W. 59,7 cm B							
	VANO A GIORNO IN METALLO "L10" VERSIONE LACCATO OPACO "L10" METAL OPEN COMPARTMENT VERSION MATT LACQUERED	72	34	15	TL34006	349	349	349
	VANO A GIORNO IN METALLO "L10" VERSIONE LACCATO OPACO "L10" METAL OPEN COMPARTMENT VERSION MATT LACQUERED	72	34	45	PR45H03	131	141	164
	Totale A+B				480	490	513	

**PENSILE 1 ANTA, 1 ripiano
CON VANO A GIORNO LATERALE,**
 Composto da:
 - elemento a giorno "L10" **A**
 - scocca nobilitato con anta L.59,7 cm **B**
 WALL UNIT 1 DOOR, 1 shelf
 WITH SIDE OPEN COMPARTMENT
 Composed of:
 - "L10" open compartment **A**
 - melamine carcass with door W. 59,7 cm **B**

ELEMENTO A GIORNO "L10" VERSIONE LACCATO OPACO "L10" OPEN ELEMENT VERSION MATT LACQUERED	72	34	15	TL34006	436	436	436
ELEMENTO A GIORNO "L10" VERSIONE LACCATO OPACO "L10" OPEN ELEMENT VERSION MATT LACQUERED	72	34	45	PR45H03	131	141	164
Totale A+B					567	577	600
ELEMENTO A GIORNO "L10" VERSIONE TERMO STRUTTURATO - LAMINATO MATERICO - NOBILITATO "L10" OPEN ELEMENT VERSION THERMO TEXTURED - TEXTURED LAMINATE - MELAMINE	72	34	15	TL34006	260	260	260
ELEMENTO A GIORNO "L10" VERSIONE TERMO STRUTTURATO - LAMINATO MATERICO - NOBILITATO "L10" OPEN ELEMENT VERSION THERMO TEXTURED - TEXTURED LAMINATE - MELAMINE	72	34	45	PR45H03	131	141	164
Totale A+B					391	401	424



METROPOLIS

ELEMENTI CARATTERIZZANTI

CHARACTERISTIC ELEMENTS

EVOLUTION 2021

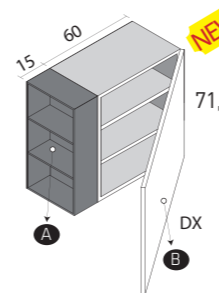
STRUTTURA STRUCTURE	DESCRIZIONE DESCRIPTION	H.(cm) H.(cm)	PR.(cm) D.(cm)	L.(cm) W.(cm)	CODICE CODE	E1	E2	E4
	PENSILE 1 ANTA, 1 ripiano CON VANO A GIORNO LATERALE Composto da: - vano a giorno in metallo "L10" A - scocca nobilitato con anta L.74,7 cm B WALL UNIT 1 DOOR, 1 shelf WITH SIDE OPEN COMPARTMENT Composed of: - "L10" metal open compartment A - melamine carcass with door W. 74,7 cm B							
	COMPARTIMENTO ABIERTO DE METAL "L10" VERSION LACADO MATE "L10" METAL OPEN COMPARTMENT VERSION MATT LACQUERED	72	34	15	TL34006	349	349	349
	COMPARTIMENTO ABIERTO DE METAL "L10" VERSION LACADO MATE "L10" METAL OPEN COMPARTMENT VERSION MATT LACQUERED	72	34	60	PR60H08	154	170	203
	Totale A+B				503	519	552	

**PENSILE 1 ANTA, 1 ripiano
CON VANO A GIORNO LATERALE**
 Composto da:
 - elemento a giorno "L10" **A**
 - scocca nobilitato con anta L.74,7 cm **B**
 WALL UNIT 1 DOOR, 1 shelf
 WITH SIDE OPEN COMPARTMENT
 Composed of:
 - "L10" open compartment **A**
 - melamine carcass with door W. 74,7 cm **B**

ELEMENTO A GIORNO "L10" VERSIONE LACCATO OPACO "L10" OPEN ELEMENT VERSION MATT LACQUERED	72	34	15	TL34006	436	436	436
ELEMENTO A GIORNO "L10" VERSIONE LACCATO OPACO "L10" OPEN ELEMENT VERSION MATT LACQUERED	72	34	60	PR60H08	154	170	203
Totale A+B					590	606	639
ELEMENTO A GIORNO "L10" VERSIONE TERMO STRUTTURATO - LAMINATO MATERICO - NOBILITATO "L10" OPEN ELEMENT VERSION THERMO TEXTURED - TEXTURED LAMINATE - MELAMINE	72	34	15	TL34006	260	260	260
ELEMENTO A GIORNO "L10" VERSIONE TERMO STRUTTURATO - LAMINATO MATERICO - NOBILITATO "L10" OPEN ELEMENT VERSION THERMO TEXTURED - TEXTURED LAMINATE - MELAMINE	72	34	60	PR60H08	154	170	203
Totale A+B					414	430	463



Per colorazioni disponibili per ELEMENTI A GIORNO "L10" e VANI A GIORNO IN METALLO vedi pg. 210-211-218
 For colors available for "L10" OPEN ELEMENT and METAL OPEN COMPARTMENT see pg. 210-211-218



Per colorazioni disponibili per ELEMENTI A GIORNO "L10" e VANI A GIORNO IN METALLO vedi pg. 210-211-218
 For colors available for "L10" OPEN ELEMENT and METAL OPEN COMPARTMENT see pg. 210-211-218

METROPOLIS

ELEMENTI CARATTERIZZANTI

CHARACTERISTIC ELEMENTS

EVOLUTION 2021

CHARACTERISTIC ELEMENTS

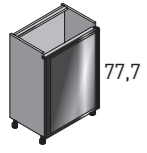
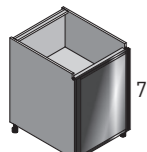
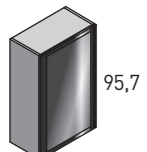
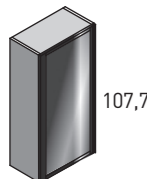
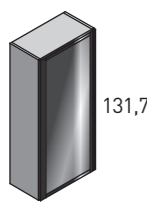
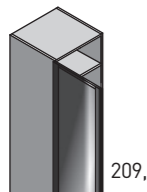
STRUTTURA STRUCTURE	DESCRIZIONE DESCRIPTION	H.(cm) H.(cm)	PR.(cm) D.(cm)	L.(cm) W.(cm)	CODICE CODE	TIPO 1 TYPE 1 TELAIO NERO SPAZZOLATO - TITANIO BLACK BRUSHED - TITANIUM FRAME	NEW TIPO 2 TYPE 2 TELAIO NERO SPAZZOLATO - TITANIO BLACK BRUSHED - TITANIUM FRAME
 77,7	BASE 1 ANTA, 2 ripiani vetro BASE UNIT 1 DOOR, 2 shelves glass	78/81	34	45	BT45H04	346	353
		78/81	34	60	BT60H09	376	402
 77,7	BASE 2 ANTE, 2 ripiani vetro BASE UNIT 2 DOORS, 2 shelves glass	78/81	34	90	BT90H07	635	649
 77,7	BASE 1 ANTA, 2 ripiani vetro BASE UNIT 1 DOOR, 2 shelves glass	78/81	59	45	BT45H00	342	349
		78/81	59	60	BT60H00	375	401
 59,7	PENSILE 1 ANTA, 1 ripiano vetro WALL UNIT 1 DOOR, 1 shelf glass	60	34	60	PR60F00	322	349
 71,7	PENSILE 1 ANTA, 1 ripiano vetro WALL UNIT 1 DOOR, 1 shelf glass	72	34	30	PR30H00	310	308
		72	34	45	PR45H00	323	331
		72	34	60	PR60H00	345	732
 95,7	PENSILE 1 ANTA, 2 ripiani vetro WALL UNIT 1 DOOR, 2 shelves glass	96	34	30	PR30J00	366	346
		96	34	45	PR45J00	381	390
		96	34	60	PR60J00	401	438
 107,7	PENSILE 1 ANTA, 3 ripiani vetro WALL UNIT 1 DOOR, 3 shelves glass	108	34	30	PR30L00	419	--
		108	34	45	PR45L00	434	--
		108	34	60	PR60L00	478	--
 131,7	PENSILE 1 ANTA, 3 ripiani vetro WALL UNIT 1 DOOR, 3 shelves glass	132	34	30	PR30N00	451	--
		132	34	45	PR45N00	462	538
		132	34	60	PR60N00	509	613
 131,7 77,7	COLONNA DISPENSA 1 ANTA, 4 ripiani vetro TALL LARDER UNIT 1 DOOR, 4 shelves glass	210	34	45	CD45P12	766	849
		210	34	60	CD60P12	839	969
		210	59	45	CD45P00	807	890
		210	59	60	CD60P00	901	1031
 209,7	COLONNA DISPENSA ANTA UNICA, 5 ripiani vetro TALL LARDER UNIT SINGLE DOOR, 5 shelves glass	210	59	45	CD45P17	641	681
		210	59	60	CD60P17	706	764
		210	59	45	CD45P18	699	739
		210	59	60	CD60P18	768	826

METROPOLIS

ELEMENTI CARATTERIZZANTI

CHARACTERISTIC ELEMENTS

EVOLUTION 2021

STRUTTURA STRUCTURE	DESCRIZIONE DESCRIPTION	H.(cm) H.(cm)	PR.(cm) D.(cm)	L.(cm) W.(cm)	CODICE CODE	E1	E2	E4
 131,7 77,7	COLONNA DISPENSA 1 ANTA PIENA 1 VETRO, 2 ripiani vetro e 2 ripiani nobilitato TALL LARDER UNIT 1 DOOR 1 GLASS, 4 shelves glass and 2 shelves melamine	210	59	30	CD30P66	562	565	586
		210	59	45	CD45P67	612	619	647
		210	59	60	CD60P67	681	691	733
 71,7 59,7 77,7	COLONNA DISPENSA 1 ANTA PIENA 1 VETRO 1 PIENA, 1 ripiano vetro e 3 ripiani nobilitato TALL LARDER UNIT 1 DOOR 1 GLASS 1 DOOR, 1 shelf glass and 3 shelves melamine	210	59	60	CD60P68	624	645	710
		210	59	60	CD60P68	651	672	737
 95,7 59,7 77,7	COLONNA DISPENSA 1 ANTA PIENA 1 VETRO 1 PIENA, 1 ripiano vetro e 4 ripiani nobilitato TALL LARDER UNIT 1 DOOR 1 GLASS 1 DOOR, 1 shelf glass and 4 shelves melamine	234	59	60	CD60T73	655	681	752
		234	59	60	CD60T73	682	708	779

STRUTTURA STRUCTURE	DESCRIZIONE DESCRIPTION	H.(cm) H.(cm)	PR.(cm) D.(cm)	L.(cm) W.(cm)	CODICE CODE	E1	E2	E4
	STRUTTURA PENSILE VASISTAS (senza anta) da utilizzare per pensile maxi CARCASS WALL UNIT W/LIFT-UP DOOR (without door) to be used for maxi wall unit	36	34	45	PS45B00	55	55	55
		36	34	60	PS60B00	59	59	59
		NEW 36	34	75	PS75B00	69	69	69
		36	34	90	PS90B00	69	69	69
		36	34	120	PS12B00	96	96	96
	STRUTTURA COLAPIATTI VASISTAS (senza anta), 1 griglia portapiatti da utilizzare per pensile maxi	36	34	60	SS60B00	84	84	84
		NEW 36	34	75	SS75B00	104	104	104
		36	34	90	SS90B00	118	118	118
		36	34	120	SS12B00	187	187	187
		DISH DRAINER CARCASS W/LIFT-UP DOOR (without door) 1 plate-rack to be used for maxi wall unit		36	34	120	SS12B00	187
Maggiorazione vaschetta inox raccogliogocce (vaschetta inox raccogliogocce inclusa nel colapiatti da 120) Surcharge steel drip tray (steel tray included in the dish drainer 120)		60	-	-	-	+20	+20	+20
		90	-	-	-	+26	+26	+26
	ANTA PER PENSILE MAXI Anta compresa di ferramenta DOOR FOR MAXI WALL UNIT Door including hardware	36	-	150	-	232	234	285
		36	-	180	-	241	243	305
		36	-	210	-	251	253	323
		36	-	240	-	261	263	345
		Maggiorazione vaschetta inox raccogliogocce (vaschetta inox raccogliogocce inclusa nel colapiatti da 120) Surcharge steel drip tray (steel tray included in the dish drainer 120)		60	-	-	-	+20
		90	-	-	-	+26	+26	+26
	STRUTTURA PENSILE VASISTAS (senza anta) da utilizzare per pensile maxi CARCASS WALL UNIT W/LIFT-UP DOOR (without door) to be used for maxi wall unit	48	34	45	PS45D00	69	69	69
		48	34	60	PS60D00	74	74	74
		NEW 48	34	75	PS75D00	83	83	83
		48	34	90	PS90D00	89	89	89
		48	34	120	PS12D00	125	125	125
	STRUTTURA COLAPIATTI VASISTAS (senza anta), 1 griglia portapiatti da utilizzare per pensile maxi	48	34	60	SS60D00	88	88	88
		NEW 48	34	75	SS75D00	107	107	107
		48	34	90	SS90D00	122	122	122
		48	34	120	SS12D00	192	192	192
		DISH DRAINER CARCASS W/LIFT-UP DOOR (without door) 1 plate-rack to be used for maxi wall unit		48	34	120	SS12D00	192
Maggiorazione vaschetta inox raccogliogocce (vaschetta inox raccogliogocce inclusa nel colapiatti da 120) Surcharge steel drip tray (steel tray included in the dish drainer 120)		60	-	-	-	+20	+20	+20
		90	-	-	-	+26	+26	+26
	ANTA PER PENSILE MAXI Anta compresa di ferramenta DOOR FOR MAXI WALL UNIT Door including hardware	48	-	150	-	245	252	317
		48	-	180	-	257	259	349
		48	-	210	-	269	274	361
		48	-	240	-	282	288	387
		Maggiorazione vaschetta inox raccogliogocce (vaschetta inox raccogliogocce inclusa nel colapiatti da 120) Surcharge steel drip tray (steel tray included in the dish drainer 120)		60	-	-	-	+20
		90	-	-	-	+26	+26	+26

Possibilità di inserire a richiesta con maggiorazione il colapiatti DELUXE (vedi articolo alla sezione MAGGIORAZIONI)
Possibility of inserting the DELUXE dish drainer on request with surcharge (see article in the section SURCHARGES)

Per finiture TERMO STRUTTURATO e LAMINATO MATERICO senso vena orizzontale nelle ante
For THERMO TEXTURED and TEXTURED LAMINATE finished with horizontal grain on the doors

STRUTTURA STRUCTURE	DESCRIZIONE DESCRIPTION	H.(cm) H.(cm)	PR.(cm) D.(cm)	L.(cm) W.(cm)	CODICE CODE	E1	E2	E4	
	PENSILE CAPPA VASISTAS, motore SMART 80 HOOD UNIT W/LIFT-UP DOOR, SMART 80 motor	24	42	150	DS15101	809	825	844	
		con scocca nobilitato with carcass melamine	24	42	150	DS15101	998	1014	1159
		con scocca finitura anta with carcass finish door	24	42	150	DS15101	998	1014	1159
		Maggiorazione per motore cappa SMART Surcharge for SMART hood motor		+150	+150	+150			
		Maggiorazione per motore cappa VAPORE MINI ANTICONDENSA Surcharge for VAPORE MINI ANTICONDENSA hood motor		+710	+710	+710			
	PENSILE CAPPA VASISTAS, motore SMART 80 HOOD UNIT W/LIFT-UP DOOR, SMART 80 motor	24	42	150	DS15100	809	825	844	
		con scocca nobilitato with carcass melamine	24	42	150	DS15100	998	1014	1159
		con scocca finitura anta with carcass finish door	24	42	150	DS15100	998	1014	1159
		Maggiorazione per motore cappa SMART Surcharge for SMART hood motor		+150	+150	+150			
		Maggiorazione per motore cappa VAPORE MINI ANTICONDENSA Surcharge for VAPORE MINI ANTICONDENSA hood motor		+710	+710	+710			
	PENSILE CAPPA VASISTAS, motore SMART 80 HOOD UNIT W/LIFT-UP DOOR, SMART 80 motor	24	42	180	DS18101	850	881	926	
		con scocca nobilitato with carcass melamine	24	42	180	DS18101	1039	1070	1241
		con scocca finitura anta with carcass finish door	24	42	180	DS18101	1039	1070	1241
		Maggiorazione per motore cappa SMART Surcharge for SMART hood motor		+150	+150	+150			
		Maggiorazione per motore cappa VAPORE MINI ANTICONDENSA Surcharge for VAPORE MINI ANTICONDENSA hood motor		+710	+710	+710			
	PENSILE CAPPA VASISTAS, motore SMART 80 HOOD UNIT W/LIFT-UP DOOR, SMART 80 motor	24	42	180	DS18100	850	881	926	
		con scocca nobilitato with carcass melamine	24	42	180	DS18100	1039	1070	1241
		con scocca finitura anta with carcass finish door	24	42	180	DS18100	1039	1070	1241
		Maggiorazione per motore cappa SMART Surcharge for SMART hood motor		+150	+150	+150			
		Maggiorazione per motore cappa VAPORE MINI ANTICONDENSA Surcharge for VAPORE MINI ANTICONDENSA hood motor		+710	+710	+710			

Per finiture TERMO STRUTTURATO e LAMINATO MATERICO senso vena orizzontale nelle ante
For THERMO TEXTURED and TEXTURED LAMINATE finished with horizontal grain on the doors

Possibilità di avere il mobile con la scocca in finitura nobilitato (rosè o vulcan o white) oppure nelle finiture delle ante del modello ad eccezione di quelle in PET
Possibility to have the unit with the cabinet with melamine finish (rosè or vulcan or white) or in the finish of the unit's doors with the exception of PET

Strutture trasversali

Transversal structures

BASI / BASE UNITS

Basi / Base units **h. 78/81 p. 34 - 40 - 59 - 72**

Basi ribassate / Lowered base units **h. 19,5/21,75 p. 47 - 59**

Basi ribassate / Lowered base units **h. 39/40,5 p. 34 - 47 - 59**

Basi ribassate / Lowered base units **h. 63/66 p. 59 -72**

Basi sospese / Wall-hung base units **h. 19,5/21,75 p. 47**

Basi sospese / Wall-hung base units **h. 39/40,5 p. 34 - 47 - 59**

PENSILI / WALL UNITS

Pensili / Wall units **h. 36 p. 34**

Pensili / Wall units **h. 48 p. 34**

Pensili / Wall units **h. 60 p. 34**

Pensili / Wall units **h. 72 p. 34**

Pensili / Wall units **h. 96 p. 34**

Pensili / Wall units **h. 108 p. 34**

Pensili / Wall units **h. 132 p. 34**

COLONNE / TALL UNITS

Sopra colonne / Over Tall units **h. 36 p. 59**

Sopra colonne / Over Tall units **h. 48 p. 59**

Colonne / Tall units **h. 138/141 p. 59**

Colonne sospese / Wall-hung Tall units **h. 129/132 p. 59**

Colonne sospese / Wall-hung Tall units **h. 153/156 p. 59**

Colonne / Tall units **h. 210 p. 59**



Colonne / Tall units **h. 234 p. 59**

COLONNE CON ANTE "RETRATTILI" / TALL UNITS WITH "RETRACTING" DOORS

BASI

BASE UNITS

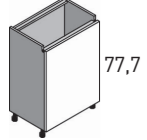
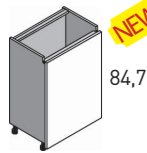
h.78-81 (CON GOLA - MANGIA LINEAR - MANIGLIA GRIP)
(WITH GROOVE - LINEAR HANDLE - GRIP HANDLE) /p.34

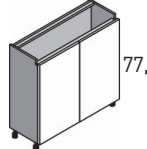
STRUTTURA STRUCTURE	DESCRIZIONE DESCRIPTION	LARGH. (cm) WIDTH (cm)	CODICE CODE
	FASCIA TAMPONAMENTO FILLER	3/15	BM00H00
 77,7	BASE 1 ANTA, 2 ripiani BASE UNIT 1 DOOR, 2 shelves	45 60 75	BT45H04 BT60H09 BT75H00
 84,7 NEW 	BASE 1 ANTA, 2 ripiani BASE UNIT 1 DOOR, 2 shelves	45 60 75	BT45H06 BT60H12 BT75H02
 77,7	BASE 2 ANTE, 2 ripiani BASE UNIT 2 DOORS, 2 shelves	90	BT90H07

**BASI PER ELETTRODOMESTICI**

APPLIANCE BASE UNITS

h.78-81 (CON GOLA - MANGIA LINEAR - MANIGLIA GRIP)
(WITH GROOVE - LINEAR HANDLE - GRIP HANDLE) /p.40

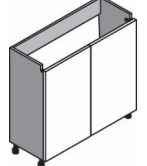
STRUTTURA STRUCTURE	DESCRIZIONE DESCRIPTION	LARGH. (cm) WIDTH (cm)	CODICE CODE
 71,7	BASE 2 ANTE PER CAPPE DOWNDRAFT, aspirante - filtrante Per basi retro penisola, isola BASE UNIT 2 DOORS FOR DOWNDRAFT HOOD, suction - filtering For base units peninsula, island	90 120	FT90H01 FT12H01

Struttura disponibile solo con Zoccolo H. 8 cm
Structure available only with Plinth H. 8 cm

E1	E2	E4
77	80	87
142	149	177
161	172	214
175	189	246
180	185	219
202	206	249
216	227	282
227	240	297

E1	E2	E4
197	209	266
230	251	335

BASI

BASE UNITS

h.78-81 (CON GOLA - MANGIA LINEAR - MANIGLIA GRIP)
(WITH GROOVE - LINEAR HANDLE - GRIP HANDLE) /p.59

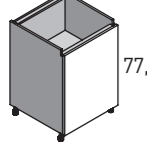
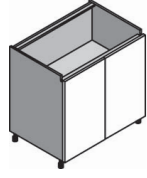
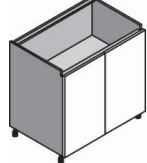
STRUTTURA STRUCTURE	DESCRIZIONE DESCRIPTION	LARGH. (cm) WIDTH (cm)	CODICE CODE
	FASCIA TAMPONAMENTO FILLER	3/15	BM00H00
 77,7	BASE 1 ANTA, 2 ripiani BASE UNIT 1 DOOR, 2 shelves	15	BT15H00
		30	BT30H00
		40	BT40H00
		45	BT45H00
		60	BT60H00
		75	BT75H01
 77,7	BASE 2 ANTE, 2 ripiani BASE UNIT 2 DOORS, 2 shelves	80	BT80H00
		90	BT90H00
		120	BT12H00
 77,7	BASE 2 ANTE PREDISPOSTA PER PIANO COTTURA CON CAPPA INTEGRATA, 1 ripiano BASE UNIT 2 DOORS PREPARED FOR COOKING HOB WITH INTEGRA HOOD, 1 shelf	90	FT90H00

E1	E2	E4
77	80	87
112	115	123
115	118	139
132	137	165
138	144	173
160	171	199
199	214	270
221	231	278
233	245	291
291	312	370
236	248	305

BASI ESTRAIBILI

PULL-OUT BASE UNITS

h.78-81 [CON GOLA - MANGILA LINEAR - MANIGLIA GRIP]
[WITH GROOVE - LINEAR HANDLE - GRIP HANDLE] /p.59

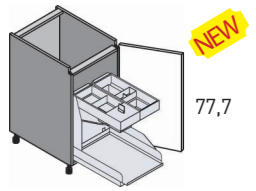
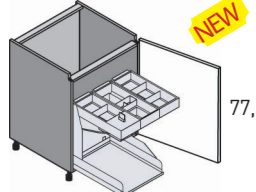
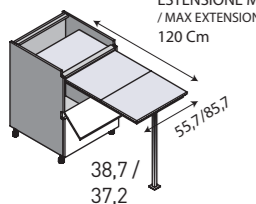
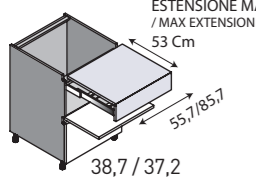
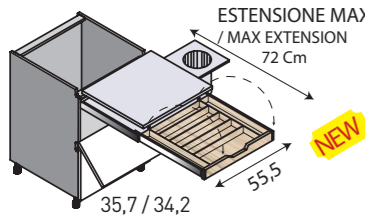
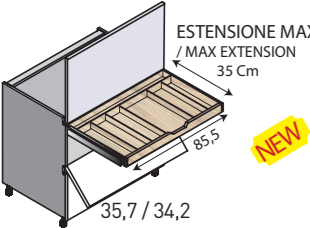
STRUTTURA STRUCTURE	DESCRIZIONE DESCRIPTION	LARGH. (cm) WIDTH (cm)	CODICE CODE
 NEW 77,7	BASE 1 ANTA, con estabile attrezzato TOWER 450 ferramenta colore Antracite BASE UNIT 1 DOOR, with TOWER 450 equipped hatch colors hardware Antracite	45	BD45H07
 NEW 77,7	BASE 1 ANTA, con estabile attrezzato TOWER 600 ferramenta colore Antracite BASE UNIT 1 DOOR, with TOWER 600 equipped hatch colors hardware Antracite	60	BD60H05
 ESTENSIONE MAX. / MAX EXTENSION 120 Cm 38,7 / 37,2	BASE 2 CESTI CON TAVOLO ESTRAIBILE, 1 Frontale a ribalta superiore + 1 cesto inferiore Prolunga telescopica laminato bordo abs in tinta sp. 2 cm, gamba acciaio BASE UNIT 2 DEEP-PAN DRAWERS WITH PULL-OUT TABLE 1 Front flap door upper + 1 lower deep-pan drawer Telescopic extension laminate matching abs edge th. 2 cm, steel leg	60	BB60H01
	MAGGIORAZIONE PER PROLUNGA TELESCOPICA FENIX SP. 2 CM SURCHARGE FOR EXTENSION TELESCOPIC FENIX TH. 2 CM	90	BB90H01
 ESTENSIONE MAX. / MAX EXTENSION 53 Cm 38,7 / 37,2	BASE 2 CESTI CON PIANO DI LAVORO ESTRAIBILE, 1 Frontale a ribalta superiore + 1 cesto inferiore Prolunga laminato bordo abs in tinta sp. 2 cm BASE UNIT 2 DEEP-PAN DRAWERS WITH PULL-OUT WORKING WORKTOP 1 Front flap door upper + 1 lower deep-pan drawer Extension laminate matching abs edge th. 2 cm	60	BB60H02
	MAGGIORAZIONE PER PROLUNGA FENIX SP. 2 CM SURCHARGE FOR EXTENSION FENIX TH. 2 CM	90	BB90H02
 ESTENSIONE MAX. / MAX EXTENSION 72 Cm 35,7 / 34,2 NEW	BASE ESTRAIBILE CON PIANO DI LAVORO ESTRAIBILE "COOK", Prolunga laminato bordo abs in tinta sp. 2 cm "COOK" PULL-OUT BASE UNIT WITH PULL-OUT WORKING WORKTOP Extension laminate matching abs edge th. 2 cm	60	BB60H03
	MAGGIORAZIONE PER PROLUNGA FENIX SP. 2 CM SURCHARGE FOR EXTENSION FENIX TH. 2 CM	90	BB90H03
 ESTENSIONE MAX. / MAX EXTENSION 35 Cm 35,7 / 34,2 NEW	BASE ESTRAIBILE CON PIANO DI LAVORO ESTRAIBILE "FUNCTIONAL", Prolunga laminato bordo abs in tinta sp. 2 cm "FUNCTIONAL" PULL-OUT BASE UNIT WITH PULL-OUT WORKING WORKTOP Extension laminate matching abs edge th. 2 cm	90	BB90H03
	MAGGIORAZIONE PER PROLUNGA FENIX SP. 2 CM SURCHARGE FOR EXTENSION FENIX TH. 2 CM	90	-

E1	E2	E4
536	542	571
605	616	658
1304	1312	1350
1490	1503	1568
+ 80	+ 80	+ 80
+ 80	+ 80	+ 80
944	953	991
1029	1042	1107
+ 39	+ 39	+ 39
+ 39	+ 39	+ 39
1629	1637	1675
+ 210	+ 210	+ 210
1463	1476	1541
+ 63	+ 63	+ 63



 Per colorazioni disponibili per i piani Fenix e Laminato vedi listino ELEMENTI UNIVERSALI
For available colors for Fenix and Laminate worktops see UNIVERSAL ELEMENTS price list

 **Attenzione!**, se viene scelto un modello con maniglia, tale verrà rimossa nel cesto inferiore per permettere una corretta estrazione del tavolo estraibile.
Al suo posto sarà inserito come sistema di apertura del cesto inferiore il Push/Pull e applicata relativa maggiorazione + 52 PTS.
Attention! If a model with handles is chosen, the handle will be removed from the lower deep-pan drawer so the pull-out table can be properly extracted.
A Push/Pull mechanism will be fitted instead, and a surcharge of + 52 PTS will be applied.

BASI ESTRAIBILI

PULL-OUT BASE UNITS

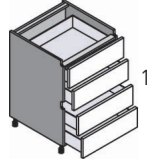
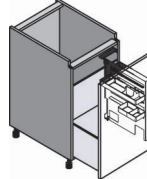
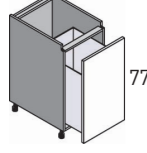
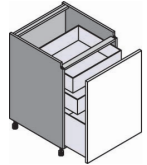
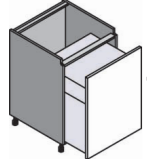
h.78-81 (CON GOLA - MANGIA LINEAR - MANIGLIA GRIP)
(WITH GROOVE - LINEAR HANDLE - GRIP HANDLE) /p.59

STRUTTURA STRUCTURE	DESCRIZIONE DESCRIPTION	LARGH. (cm) WIDTH (cm)	CODICE CODE	
 19,2 / 18,45	BASE 4 CASSETTI BASE UNIT 4 DRAWERS	40	BG40H00	
		45	BG45H00	
		60	BG60H00	
		NEW 75	BG75H00	
		90	BG90H00	
		NEW 105	BG10H00	
 77,7				
	BASE ESTRAIBILE PORTAOGGETTI "SOUS-CHEF", ferramenta colore Grigio Orione "SOUS-CHEF" PULL-OUT BASE UNIT GLOVE, colors hardware Grigio Orione	45	BD45H06	
 77,7				
	BASE ESTRAIBILE, ferramenta colore Stone o Titanio PULL-OUT BASE UNIT, colors hardware Stone or Titanio	15	BD15H00	
		30	BD30H00	
 77,7				
	BASE CESTO ESTRAIBILE, 2 cassetti interni BASE UNIT W/PULL-OUT DEEP-PAN DRAWER , 2 inner drawers	45	BD45H01	
		60	BD60H00	
		NEW 75	BD75H00	
		90	BD90H00	
	Trascinatore per cassetto interno Dragger for inner drawer	cad. 1	GFN0060	
 77,7				
	BASE 1 CESTONE CON PATTUMIERA ESTRAIBILE, ferramenta colore Grigio Chiaro o Antracite BASE UNIT 1 DEEP-PAN DRAWER WITH PULL-OUT WASTE BIN, colors hardware Light Grey or Anthracite	[1 secchio da 26lt. + 1 secchio da 17lt. + 2 secchi da 8lt.] <small>[1 bin of 26L + 1 bin of 17L + 2 bins of 8L]</small>	60	BD60H02
 77,7				
	BASE 1 CESTONE CON PATTUMIERA ESTRAIBILE CON CASSETTO PORTASPUGNE previste colore Stone BASE UNIT 1 DEEP-PAN DRAWER WITH PULL-OUT WASTE BIN WITH DRAWER SPONGE HOLDER available colours Stone	[1 secchio da 22lt. + 2 secchi da 10lt.] <small>[1 bin of 22L + 2 bins of 10L]</small>	60	BD60H03
		[1 secchio da 22lt. + 2 secchi da 10lt.] <small>[1 bin of 22L + 2 bins of 10L]</small>	90	BD90H01

E1	E2	E4
405	413	455
407	415	457
449	461	499
521	530	567
557	565	620
558	566	621
437	444	472
164	167	176
213	216	237
399	406	434
405	415	457
475	490	546
516	534	598
+ 15	+ 15	+ 15
491	501	533
531	541	573
664	682	746

BASI ESTRAIBILI

PULL-OUT BASE UNITS

h.78-81 (CON GOLA - MANGIA LINEAR - MANIGLIA GRIP)
(WITH GROOVE - LINEAR HANDLE - GRIP HANDLE) /p.59

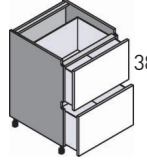
STRUTTURA STRUCTURE	DESCRIZIONE DESCRIPTION	LARGH. (cm) WIDTH (cm)	CODICE CODE
 38,7 / 37,2	BASE 2 CESTI BASE UNIT 2 DEEP-PAN DRAWERS	45	BE45H00
		60	BE60H00
		NEW 75	BE75H00
		90	BE90H00
		120	BE12H00
		NEW 105	BE10H00

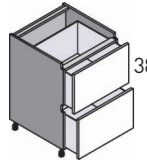
 38,7 / 37,2	BASE 2 CESTI PREDISPOSTA PER PIANO COTTURA CON CAPPA INTEGRATA, Cesti con guide ammortizzate prof. 40 cm BASE UNIT 2 DEEP-PAN DRAWERS PREPARED FOR COOKING HOB WITH INTEGRATED HOOD, deep-pan drawers with soft-closing runners depth 40 cm	90	FE90H00
--	---	----	---------

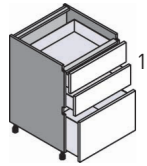
 19,2 / 18,45 38,7 / 37,2	BASE 2 CASSETTI 1 CESTO BASE UNIT 2 DRAWERS 1 DEEP-PAN DRAWER	45	BF45H00
		60	BF60H00
		NEW 75	BF75H00
		90	BF90H00
		NEW 105	BF10H00
		120	BF12H00

E1	E2	E4
291	298	325
314	323	361
349	362	406
367	380	445
507	528	607
470	489	556







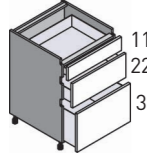

349	362	427
-----	-----	-----

341	348	383
367	377	415
414	425	466
426	436	496
508	521	584
533	548	629

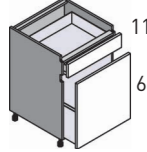
BASI ESTRAIBILI

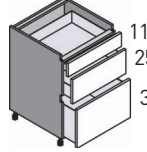
PULL-OUT BASE UNITS

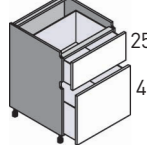
h.81 (CON GOLA)
(WITH GROOVE) /p.59

STRUTTURA STRUCTURE	DESCRIZIONE DESCRIPTION	LARGH. (cm) WIDTH (cm)	CODICE CODE
 11,7 22,2 37,2 NEW	BASE 2 CASSETTI 1 CESTO (1 gola superiore e 2 gole intermedie) BASE UNIT 2 DRAWERS 1 DEEP-PAN DRAWER (1 upper groove and 2 intermediate grooves)	60	BF60H05
		75	BF75H01
		90	BF90H08
		105	BF10H01
		120	BF12H02
			
 11,7 62,7 NEW	BASE 1 CASSETTO 1 CESTO (1 gola superiore e 1 gola intermedia) BASE UNIT 1 DRAWER 1 DEEP-PAN DRAWER (1 upper groove and 1 intermediate groove)	60	BF60H06
		75	BF75H02
		90	BF90H09
		105	BF10H02
			
 11,7 25,2 37,2 NEW	BASE 1 CASSETTO 2 CESTI (1 gola superiore e 1 gola intermedia) BASE UNIT 1 DRAWER 2 DEEP-PAN DRAWERS (1 upper groove and 1 intermediate groove)	60	BF60H07
		75	BF75H03
		90	BF90H10
		105	BF10H03
		120	BF12H03
			
 25,2 49,2 NEW	BASE 2 CESTI (1 gola superiore e 1 gola intermedia) BASE UNIT 2 DEEP-PAN DRAWERS (1 upper groove and 1 intermediate groove)	60	BE60H02
		75	BE75H01
		90	BE90H04
		105	BE10H01
		120	BE12H02
			

E1	E2	E4
380	390	432
423	436	483
443	457	517
518	533	598
545	560	636
345	360	397
392	412	460
423	443	496
455	468	537
399	410	452
445	458	506
465	479	539
575	590	655
598	613	688
264	270	298
362	369	406
388	394	441
485	493	553
504	517	587











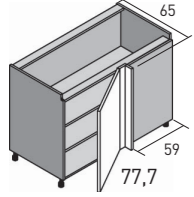

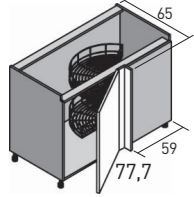

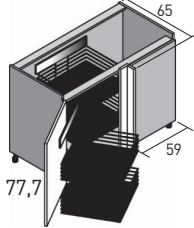
Struttura disponibile solo con gola
Structure available only with groove

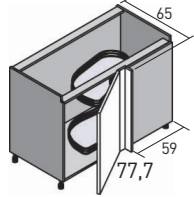
BASI ANGOLO

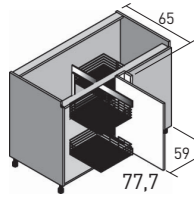
CORNER BASE UNITS

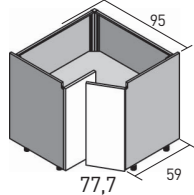
h.78-81 (CON GOLA - MANGILA LINEAR - MANIGLIA GRIP)
(WITH GROOVE - LINEAR HANDLE - GRIP HANDLE) /p.59

STRUTTURA STRUCTURE	DESCRIZIONE DESCRIPTION	LARGH. (cm) WIDTH (cm)	CODICE CODE
	BASE ANGOLO PR. 65, 2 ripiani CORNER BASE UNIT D. 65, 2 shelves	95 105 110 125	BJ95H00 BJ10H00 BJ11H00 BJ1AH00
			
	BASE ANGOLO PR. 65, 2 cesti girevoli ferramenta colore Stone o Titanio CORNER BASE UNIT D. 65, 2 swivel baskets colors hardware Stone orTitanio	110	BJ11H02
			
	BASE ANGOLO PR. 65, gruppo estraibile ferramenta colore Stone o Titanio CORNER BASE UNIT D. 65, pull-out unit colors hardware Stone orTitanio	110	BJ11H01
			
	BASE ANGOLO PR. 65, 2 cesti girevoli Freedom ferramenta colore Stone o Titanio CORNER BASE UNIT D. 65, 2 Freedom swivel baskets colors hardware Stone orTitanio	110 125	BJ11H03 BJ1AH01
			
	BASE ANGOLO PR. 65, 2 cesti estraibili ferramenta colore Stone o Titanio CORNER BASE UNIT D. 65, 2 pull-out baskets colors hardware Stone orTitanio	110 125	BJ11H04 BJ1AH02
			
	BASE ANGOLO 2 ANTE, 2 ripiani 2 DOORS CORNER BASE UNITS 2 shelves	95 x 95	BT95H00
	 		

NEW **Maggiorazione Kit**
cesti estraibili "SOUS-CHEF"
Kit surcharge
"SOUS-CHEF" pull-out baskets

E1	E2	E4
317	321	347
297	303	336
304	311	345
336	348	395
355	363	396
704	711	745
909	916	950
1013	1024	1071
949	956	990
1078	1089	1137
+ 44	+ 44	+ 44
375	384	434

BASI ANGOLO

CORNER BASE UNITS

h.78-81 (CON GOLA - MANGILA LINEAR - MANIGLIA GRIP)
(WITH GROOVE - LINEAR HANDLE - GRIP HANDLE) /p.59

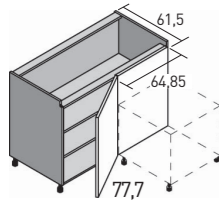
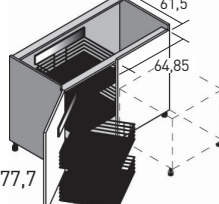
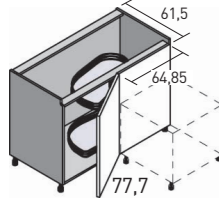
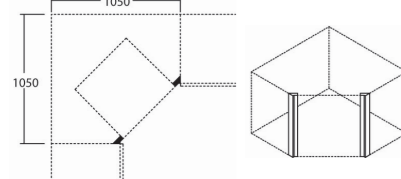
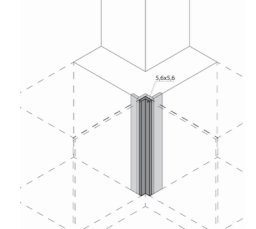
STRUTTURA STRUCTURE	DESCRIZIONE DESCRIPTION	LARGH. (cm) WIDTH (cm)	CODICE CODE
	BASE ANGOLO PR. 61,5 , 2 ripiani (tappo sp. anta) CORNER BASE UNIT D. 61,5 , 2 shelves (cap th. door)	95 105 110 125	BK95H00 BK10H00 BK11H00 BK1AH00
	BASE ANGOLO PR. 61,5 , cesti girevoli ferramenta colore Stone o Titanio (tappo sp. anta) CORNER BASE UNIT D. 61,5 , 2 swivel baskets colors hardware Stone orTitanio (cap th. door)	110	BK11H02
	BASE ANGOLO PR. 61,5 , gruppo estraibile ferramenta colore Stone o Titanio (tappo sp. anta) CORNER BASE UNIT D. 61,5 , pull-out unit colors hardware Stone orTitanio (cap th. door)	110	BK11H01
	BASE ANGOLO PR. 61,5 , 2 cesti girevoli Freedom ferramenta colore Stone o Titanio (tappo sp. anta) CORNER BASE UNIT D. 61,5 , 2 Freedom swivel baskets colors hardware Stone orTitanio (cap th. door)	110 125	BK11H03 BK1AH01
	BASE ANGOLO PR. 61,5 , 2 cesti estraibili ferramenta colore Stone o Titanio (tappo sp. anta) CORNER BASE UNIT D. 61,5 , 2 pull-out baskets colors hardware Stone orTitanio (cap th. door)	110 125 110	BK11H04 BK1AH02 -
	KIT MONTANTI ANGOLO CORNER UNIT UPRIGHTS KIT	105 x 105	FC10H00
	GOLA PER ANGOLO CIECO GROOVE FOR BLIND CORNER	5,6 x 5,6	FC10H01



NEW

Maggiorazione Kit
cesti estraibili "SOUS-CHEF"
Kit surcharge
"SOUS-CHEF" pull-out baskets

E1	E2	E4
245	261	332
262	280	359
269	288	367
315	339	431
284	303	382
638	657	735
827	846	924
931	954	1046
882	901	980
996	1019	1111
+ 44	+ 44	+ 44
123	128	151
123	124	130

BASI PER LAVELLO

SINK UNITS

h.78-81 (CON GOLA - MANGILA LINEAR - MANIGLIA GRIP)
(WITH GROOVE - LINEAR HANDLE - GRIP HANDLE) /p.59

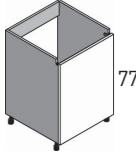
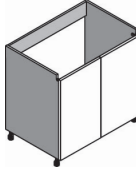
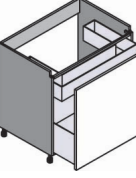
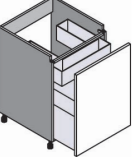
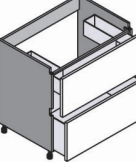
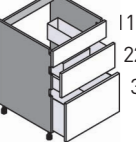
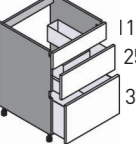
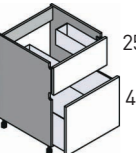
STRUTTURA STRUCTURE	DESCRIZIONE DESCRIPTION	LARGH. (cm) WIDTH (cm)	CODICE CODE	
 77,7	SOTTOLAVELLO 1 ANTA, Fondo per lavello con protezione alluminio antigraffio SINK UNIT 1 DOOR, Sink bottom with scratch-prof aluminium protection	45	LT45H00	
		60	LT60H00	
		75	LT75H00	
 77,7	SOTTOLAVELLO 2 ANTE, Fondo per lavello con protezione alluminio antigraffio SINK UNIT 2 DOORS, Sink bottom with scratch-prof aluminium protection	80	LT80H00	
		90	LT90H01	
		120	LT12H00	
 77,7	SOTTOLAVELLO CESTO ESTRAIBILE, cesto interno sagomato SINK UNIT W/PULL-OUT DEEP-PAN DRAWER, shaped inner deep-pan-drawer	75	LD75H00	
		90	LD90H00	
 77,7	SOTTOLAVELLO 1 CESTONE CON PATTUMIERA ESTRAIBILE previste colore Stone SINK UNIT W/PULL-OUT DEEP-PAN WITH PULL-OUT WASTE BIN available colours Stone	[1 secchio da 22lt. + 2 secchi da 10lt.] (1 bin of 22L + 2 bins of 10L)	60	LD60H00
		[1 secchio da 22lt. + 2 secchi da 10lt.] (1 bin of 22L + 2 bins of 10L)	90	LD90H01
 38,7 / 37,2	SOTTOLAVELLO 2 CESTI SINK UNIT 2 DEEP-PAN DRAWERS	60	LE60H00	
		75	LE75H00	
		90	LE90H00	
		120	LE12H00	
 11,7 22,2 37,2	SOTTOLAVELLO 2 CASSETTI 1 CESTO, 1 Frontale fisso (1 gola superiore e 2 gole intermedia) SINK UNIT 2 DRAWERS 1 DEEP-PAN DRAWER, 1 fixed front (1 upper groove and 2 intermediate grooves)	75	LE75H01	
		90	LE90H03	
		120	LE12H02	
 11,7 25,2 37,2	SOTTOLAVELLO 1 CASSETTO 2 CESTI, 1 Frontale fisso (1 gola superiore e 1 gola intermedia) SINK UNIT 1 DRAWER 2 DEEP-PAN DRAWERS, 1 fixed front (1 upper groove and 1 intermediate groove)	60	LE60H02	
		75	LE75H02	
		90	LE90H04	
		120	LE12H03	
 25,2 49,2	SOTTOLAVELLO 2 CESTI, 1 Frontale fisso (1 gola superiore e 1 gola intermedia) SINK UNIT 2 DEEP-PAN DRAWERS, 1 fixed front (1 upper groove and 1 intermediate groove)	60	LE60H03	
		75	LE75H03	
		90	LE90H05	



E1	E2	E4
137	143	172
164	175	201
182	197	254
209	220	277
215	227	284
265	286	370
464	478	535
488	506	570
541	552	583
678	696	760
385	393	431
423	435	479
438	451	516
532	553	633
456	470	517
473	488	548
572	586	662
416	427	469
456	470	517
473	488	548
572	586	662
261	267	294
299	306	343
321	327	374



Struttura disponibile solo con gola
Structure available only with groove

BASI PER LAVELLO

SINK UNITS

FONDO PER LAVELLO CON PROTEZIONE ALLUMINIO ANTIGRAFFIO
SINK BOTTOM WITH SCRATCH-PROOF ALUMINIUM PROTECTIONh.78-81 (CON GOLA - MANGILA LINEAR - MANIGLIA GRIP)
(WITH GROOVE - LINEAR HANDLE - GRIP HANDLE) /p.59

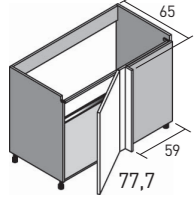
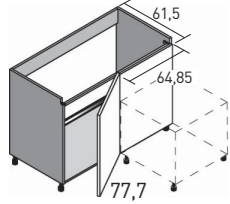
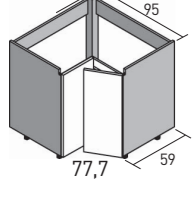
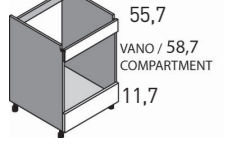
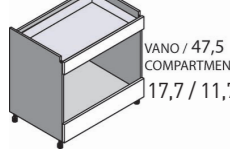
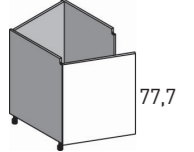
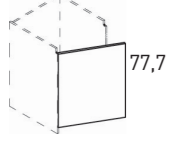
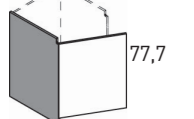

STRUTTURA STRUCTURE	DESCRIZIONE DESCRIPTION	LARGH. (cm) WIDTH (cm)	CODICE CODE
	SOTTOLAVELLO ANGOLO PR. 65 CORNER SINK UNIT D. 65	95 105 110 125	LJ95H00 LJ10H00 LJ11H00 LJ1AH00
	SOTTOLAVELLO ANGOLO PR. 61,5 CORNER SINK UNIT D. 61,5	95 105 110 125	LK95H00 LK10H00 LK11H00 LK1AH00
	SOTTOLAVELLO ANGOLO CORNER SINK UNIT	95 x 95	LT95H00
	BASE PER FORNO 1 Frontale fisso + 1 cassetto inferiore OVEN BASE UNIT 1 fixed front + 1 lower drawer	60 75	FC60H02 FC75H00
	BASE PER FORNO RIBASSATO, 1 cassetto superiore + 1 cassetto inferiore LOWERED OVEN BASE UNIT, 1 superior drawer + 1 lower drawer	90	FC90H02
	BASE PER FRIGO FRIDGE BASE UNIT	60	GH60H02
	ANTA PER FRIGO FRIDGE UNIT DOOR	60	GH60H00
	FIANCO + ANTA PER FRIGO FRIDGE UNIT SIDE PANEL + DOOR	60	GH60H01

E1	E2	E4
309	313	340
307	313	347
313	321	354
353	365	412
226	242	313
235	252	331
241	260	339
270	293	386
376	385	435
222	228	250
233	239	261
340	349	373
152	162	204
59	70	112
101	112	149

BASI PER ELETTRODOMESTICI

APPLIANCE BASE UNITS

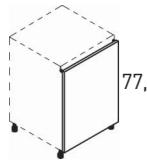
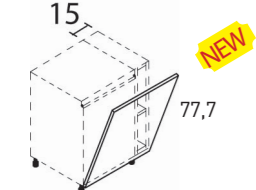
h.78-81 (CON GOLA - MANGILA LINEAR - MANIGLIA GRIP)
(WITH GROOVE - LINEAR HANDLE - GRIP HANDLE) /p.59

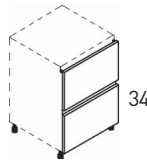
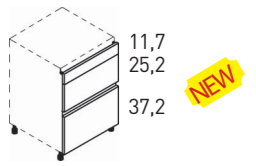
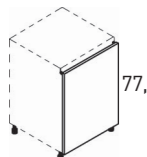
STRUTTURA STRUCTURE	DESCRIZIONE DESCRIPTION	LARGH. (cm) WIDTH (cm)	CODICE CODE
	ANTA PER LAVASTOVIGLIE, scomparsa totale cerniere sliding DISHWASHER UNIT DOOR, fully integrated appliance hinge sliding	45 60	GL45H00 GL60H00
	ANTA PER LAVASTOVIGLIE, scomparsa totale con cerniere sliding + ELEMENTO A GIORNO nobilitato colore scocca DISHWASHER UNIT DOOR, fully integrated appliance with hinge sliding + OPEN ELEMENTS melamine carcass colour	75	GL75H00
	2 CESTI PER LAVASTOVIGLIE, scomparsa totale Ante spinate DISHWASHER 2 DEEP-PAN DRAWERS, fully integrated appliance Jointed doors		
	Con Gola Scavata o Gola Piatta nelle finiture: BRILL - PIOMBO O. - BIANCO O. - TITANIO - NERO SPAZZOLATO - BRONZO With Dug Groove or Flat Groove in the finishes: BRILL - PIOMBO O. - BIANCO O. - TITANIO - NERO SPAZZOLATO - BRONZO	60	GL60H05
	Maggiorazione con Gola Scavata finitura LACCATO OPACO Surcharge with Dug Groove in the finish LACCATO OPACO	60	--
	2 CASSETTI 1 CESTO PER LAVASTOVIGLIE, scomparsa totale Ante spinate DISHWASHER 2 DRAWERS 1 DEEP-PAN DRAWER, fully integrated appliance Jointed doors		
	Con Gola Scavata o Gola Piatta nelle finiture: BRILL - PIOMBO O. - BIANCO O. - TITANIO - NERO SPAZZOLATO - BRONZO With Dug Groove or Flat Groove in the finishes: BRILL - PIOMBO O. - BIANCO O. - TITANIO - NERO SPAZZOLATO - BRONZO	60	GL60H06
	Maggiorazione con Gola Scavata finitura LACCATO OPACO Surcharge with Dug Groove in the finish LACCATO OPACO	60	-
	ANTA PER LAVATRICE WASHING MACHINE UNIT DOOR	60	GL60H01

E1	E2	E4
56	62	86
65	75	112
129	143	200
270	279	317
+ 59	+ 59	+ 59
304	314	356
+ 59	+ 59	+ 59
65	75	112



Specificare sempre la posizione del l'Elemento a giorno se DX o SX della Lavastoviglie;
Attenzione! l'Elemento a giorno non puoi mai essere posizionato come elemento terminale con lato a vista.
Always specify the position of the open element whether right or left of the dishwasher;
Warning! the open element can never be positioned as a terminal element with an exposed side

BASI

BASE UNITS

h.78-81 (CON GOLA - MANGIA LINEAR - MANIGLIA GRIP)
(WITH GROOVE - LINEAR HANDLE - GRIP HANDLE) /p.72

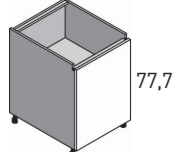
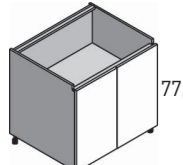
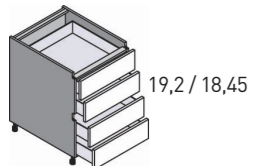
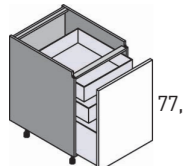
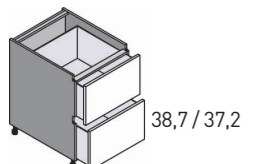
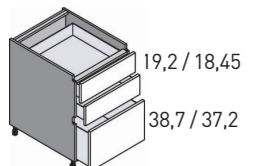
STRUTTURA STRUCTURE	DESCRIZIONE DESCRIPTION	LARGH. (cm) WIDTH (cm)	CODICE CODE
	FASCIA TAMPONAMENTO FILLER	3/15	BM00H00
	BASE 1 ANTA, 2 ripiani BASE UNIT 1 DOOR, 2 shelves	45 60 75	BT45H03 BT60H08 BT75H03
	BASE 2 ANTE, 2 ripiani BASE UNIT 2 DOORS, 2 shelves	90	BT90H06
	BASE 4 CASSETTI BASE UNIT 4 DRAWERS	45 60 75 90 105	BG45H01 BG60H01 BG75H01 BG90H01 BG10H01
	BASE CESTO ESTRAIBILE, 2 cassetti interni BASE UNIT W/PULL-OUT DEEP-PAN DRAWER, 2 inner drawers	45 60 75 90	BD45H05 BD60H04 BD75H01 BD90H02
	Trascinatore per cassetto interno Dragger for inner drawer	cad. 1	GFN0060
	BASE 2 CESTI BASE UNIT 2 DEEP-PAN DRAWERS	45 60 90 105 120	BE45H01 BE60H01 BE90H03 BE10H02 BE12H01
	BASE 2 CASSETTI 1 CESTO BASE UNIT 2 DRAWERS 1 DEEP-PAN DRAWER	45 60 75 90 105 120	BF45H01 BF60H01 BF75H04 BF90H01 BF10H04 BF12H01

Non possibile inserire portaposate PVC
PVC tray can not be inserted

E1	E2	E4
77	80	87
175	181	209
197	207	249
220	235	291
270	283	340
579	587	629
613	625	663
678	686	724
698	706	761
737	745	804
541	548	576
545	556	598
621	636	692
660	678	742
+ 15	+ 15	+ 15
396	403	430
418	427	465
474	487	552
586	605	672
601	622	702
482	490	524
508	518	556
560	571	612
578	588	648
661	675	738
685	700	782

BASI PER LAVELLO

SINK UNITS

h.78-81 [CON GOLA - MANGIA LINEAR - MANIGLIA GRIP]
[WITH GROOVE - LINEAR HANDLE - GRIP HANDLE] /p.72

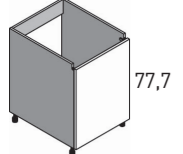
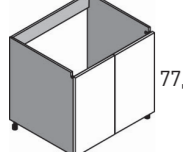
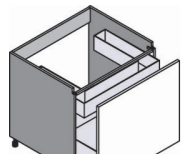
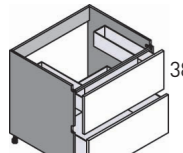
STRUTTURA STRUCTURE	DESCRIZIONE DESCRIPTION	LARGH. (cm) WIDTH (cm)	CODICE CODE
 77,7	SOTTOLAVELLO 1 ANTA, Fondo per lavello con protezione alluminio antigraffio SINK UNIT 1 DOOR, Sink bottom with scratch-prof aluminium protection	60	LT60H04
		NEW 75	LT75H01
 77,7	SOTTOLAVELLO 2 ANTE, Fondo per lavello con protezione alluminio antigraffio SINK UNIT 2 DOORS, Sink bottom with scratch-prof aluminium protection	90	LT90H04
		120	LT12H01
 77,7	SOTTOLAVELLO CESTO ESTRAIBILE, cesto interno sagomato SINK UNIT W/PULL-OUT DEEP-PAN DRAWER, shaped inner deep-pan-drawer	NEW 75	LD75H01
		90	LD90H02
 38,7 / 37,2	SOTTOLAVELLO 2 CESTI SINK UNIT 2 DEEP-PAN DRAWERS	60	LE60H01
		NEW 75	LE75H04
		90	LE90H01
		120	LE12H01

E1	E2	E4
180	191	233
201	216	272
245	258	314
292	313	397
530	544	601
555	573	637
448	456	494
489	501	545
506	518	583
606	627	707

BASI RIBASSATE

LOWERED BASE UNITS

h. 19,5-21,75 (CON GOLA - MANGILA LINEAR - MANIGLIA GRIP)
(WITH GROOVE - LINEAR HANDLE - GRIP HANDLE) /p.47

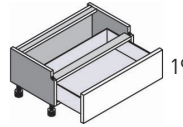
STRUTTURA STRUCTURE	DESCRIZIONE DESCRIPTION	LARGH. (cm) WIDTH (cm)	CODICE CODE
	FASCIA TAMPONAMENTO FILLER	3/15	BM00A00
 19,2 / 18,45	BASE 1 CASSETTO BASE UNIT 1 DRAWER	60	BG60A01
		90	BG90A01
		NEW 105	BG10A01
		120	BG12A01

E1

49

E2

50

E4

54

141

177

192

202

144

179

194

204

154

193

208

225

BASI RIBASSATE

LOWERED BASE UNITS

h. 19,5-21,75 (CON GOLA - MANGILA LINEAR - MANIGLIA GRIP)
(WITH GROOVE - LINEAR HANDLE - GRIP HANDLE) /p.59

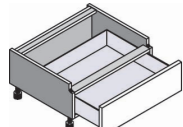
STRUTTURA STRUCTURE	DESCRIZIONE DESCRIPTION	LARGH. (cm) WIDTH (cm)	CODICE CODE
	FASCIA TAMPONAMENTO FILLER	3/15	BM00A00
 19,2 / 18,45	BASE 1 CASSETTO BASE UNIT 1 DRAWER	60	BG60A00
		90	BG90A00
		NEW 105	BG10A00
		120	BG12A00

E1

49

E2

50

E4

54

156

180

197

216

159

182

199

218

168

196

214

239

BASI RIBASSATE

LOWERED BASE UNITS

h.39-40,5 (CON GOLA - MANGIA LINEAR - MANIGLIA GRIP)
(WITH GROOVE - LINEAR HANDLE - GRIP HANDLE) /p.34

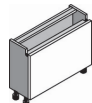
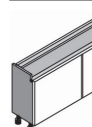
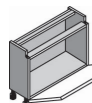
STRUTTURA STRUCTURE	DESCRIZIONE DESCRIPTION	LARGH. (cm) WIDTH (cm)	CODICE CODE
	FASCIA TAMPONAMENTO FILLER	3/15	BM00B01
 38,7 / 37,2	BASE 1 ANTA BASE UNIT 1 DOOR	45	BT45B03
		60	BT60B03
 38,7 / 37,2	BASE 2 ANTE BASE UNIT 2 DOORS	90	BT90B03
		120	BT12B02
 38,7 / 37,2	BASE 1 ANTA RIBALTA BASE UNIT 1 DOOR OPEN FLAP	45	BR45B02
		60	BR60B02
		NEW 75	BR75B02
		90	BR90B02
		NEW 105	BR10B02
		120	BR12B02

BASI RIBASSATE

LOWERED BASE UNITS

h.39-40,5 (CON GOLA - MANGIA LINEAR - MANIGLIA GRIP)
(WITH GROOVE - LINEAR HANDLE - GRIP HANDLE) /p.47

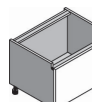
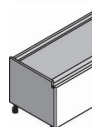
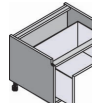
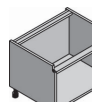
STRUTTURA STRUCTURE	DESCRIZIONE DESCRIPTION	LARGH. (cm) WIDTH (cm)	CODICE CODE
	FASCIA TAMPONAMENTO FILLER	3/15	BM00B01
 38,7 / 37,2	BASE RIBASSATA 1 ANTA LOWERED BASE UNIT 1 DOOR	45	BT45B02
		60	BT60B02
 38,7 / 37,2	BASE RIBASSATA 2 ANTE LOWERED BASE UNIT 2 DOORS	90	BT90B02
		120	BT12B01
 38,7 / 37,2	BASE RIBASSATA CESTO ESTRAIBILE LOWERED BASE UNIT W/PULL-OUT DEEP-PAN DRAWER	45	BD45B02
		60	BD60B02
		NEW 75	BD75B02
		90	BD90B02
		NEW 105	BD10B02
		120	BD12B02
 38,7 / 37,2	BASE RIBASSATA 1 ANTA RIBALTA LOWERED BASE UNIT 1 DOOR OPEN FLAP	45	BR45B01
		60	BR60B01
		NEW 75	BR75B01
		90	BR90B01
		NEW 105	BR10B01
		120	BR12B01

E1	E2	E4
67	69	75
88	91	104
98	102	121
147	154	181
172	180	218
189	193	206
200	204	223
215	221	243
225	231	264
242	251	285
244	255	294

E1	E2	E4
67	69	75
99	102	116
110	114	133
160	166	194
185	194	231
165	168	182
178	182	201
200	206	228
215	221	254
267	277	310
273	284	324
201	204	218
212	216	235
226	233	255
238	244	277
254	263	297
258	268	308

BASI RIBASSATE

LOWERED BASE UNITS

h.39-40,5 (CON GOLA - MANGIA LINEAR - MANIGLIA GRIP)
(WITH GROOVE - LINEAR HANDLE - GRIP HANDLE) /p.59

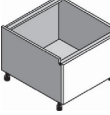
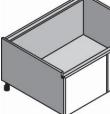
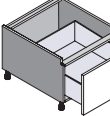
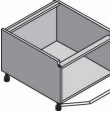





STRUTTURA STRUCTURE	DESCRIZIONE DESCRIPTION	LARGH. (cm) WIDTH (cm)	CODICE CODE
	FASCIA TAMPONAMENTO FILLER	3/15	BM00B01
 38,7 / 37,2	BASE 1 ANTA BASE UNIT 1 DOOR	45	BT45B00
		60	BT60B00
 38,7 / 37,2	BASE 2 ANTE BASE UNIT 2 DOORS	90	BT90B00
		120	BT12B00
 38,7 / 37,2	BASE CESTO ESTRAIBILE BASE UNIT W/PULL-OUT DEEP-PAN DRAWER	45	BD45B01
		60	BD60B01
		NEW 75	BD75B01
		90	BD90B01
		NEW 105	BD10B01
		120	BD12B01
 38,7 / 37,2	BASE 1 ANTA RIBALTA BASE UNIT 1 DOOR OPEN FLAP	45	BR45B00
		60	BR60B00
		NEW 75	BR75B00
		90	BR90B00
		NEW 105	BR10B00
		120	BR12B00

E1	E2	E4
67	69	75
102	105	119
114	118	137
158	164	192
194	202	240
168	172	185
182	186	205
202	208	230
218	224	257
272	282	315
287	298	338
204	207	221
216	220	239
228	235	257
241	247	280
259	268	302
271	282	322

BASI RIBASSATE

LOWERED BASE UNITS

h.63-66 (CON GOLA - MANGILA LINEAR - MANIGLIA GRIP)
(WITH GROOVE - LINEAR HANDLE - GRIP HANDLE) /p.59

STRUTTURA STRUCTURE	DESCRIZIONE DESCRIPTION	LARGH. (cm) WIDTH (cm)	CODICE CODE
	FASCIA TAMPONAMENTO FILLER	15	BM00F00
	BASE 1 ANTA, 1 ripiano BASE UNIT 1 DOOR, 1 shelf	60	BT60F00
	BASE 1 CESTO, 1 cassetto interno BASE UNIT 1 DEEP-PAN DRAWER, 1 internal drawer	60 75 90	BD60F00 BD75F00 BD90F00
	BASE 1 CASSETTO 1 CESTO BASE UNIT 1 DRAWER 1 DEEP-PAN DRAWER	60 75 90 105 120	BF60F03 BF75F00 BF90F03 BF10F00 BF12F03
	SOTTOLAVELLO 1 CESTO SINK UNIT 1 DEEP-PAN DRAWER	60 75 90	LD60F00 LD75F00 LD90F00
	SOTTOLAVELLO 1 CASSETTO 1 CESTO SINK UNIT 1 DRAWER 1 DEEP-PAN DRAWER	75 90 120	LE75F00 LE90F00 LE12F00

(NO MANGILA)
(NO HANDLE)(NO MANGILA)
(NO HANDLE)(NO MANGILA)
(NO HANDLE)













E1	E2	E4
70	72	78
158	168	192
311	318	341
384	399	433
285	291	319
319	328	361
335	344	391
404	415	468
425	437	500
429	439	462
468	483	517
414	424	456
429	437	485
523	536	599

Struttura disponibile solo con gola
Structure available only with groove

BASI RIBASSATE

LOWERED BASE UNITS

h.63-66 (CON GOLA - MANGILA LINEAR - MANIGLIA GRIP)
(WITH GROOVE - LINEAR HANDLE - GRIP HANDLE) /p.72

STRUTTURA STRUCTURE	DESCRIZIONE DESCRIPTION	LARGH. (cm) WIDTH (cm)	CODICE CODE
	FASCIA TAMPONAMENTO FILLER	15	BM00F00
	BASE 1 ANTA, 1 ripiano BASE UNIT 1 DOOR, 1 shelf	60	BT60F06
	BASE 1 CESTO, 1 cassetto interno BASE UNIT 1 DEEP-PAN DRAWER, 1 internal drawer	60 75 90	BD60F06 BD75F01 BD90F04
	  (NO MANGILA) (NO HANDLE) BASE 1 CASSETTO 1 CESTO BASE UNIT 1 DRAWER 1 DEEP-PAN DRAWER	60 75 90 105 120	BF60F04 BF75F01 BF90F04 BF10F01 BF12F04
	  (NO MANGILA) (NO HANDLE) SOTTOLAVELLO 1 CESTO SINK UNIT 1 DEEP-PAN DRAWER	60 75 90	LD60F01 LD75F01 LD90F02
	  (NO MANGILA) (NO HANDLE) SOTTOLAVELLO 1 CASSETTO 1 CESTO SINK UNIT 1 DRAWER 1 DEEP-PAN DRAWER	75 90 120	LE75F01 LE90F01 LE12F01

E1	E2	E4
70	72	78
170	180	203
423	433	456
488	503	537
516	530	571
385	391	418
423	432	465
439	448	495
515	527	579
535	548	611
493	503	527
534	550	583
550	563	604
480	490	522
498	507	554
598	611	674

Struttura disponibile solo con gola
Structure available only with groove

BASI SOSPESSE

WALL HUNG BASE UNITS

h. 19,5-21,75 (CON GOLLA - MANGILA LINEAR - MANIGLIA GRIP)
(WITH GROOVE - LINEAR HANDLE - GRIP HANDLE) /p.47

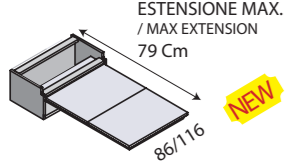
STRUTTURA STRUCTURE	DESCRIZIONE DESCRIPTION	LARGH. (cm) WIDTH (cm)	CODICE CODE
	BASE ESTRAIBILE CON PIANO DI LAVORO ESTRAIBILE "LUNCH+39", Prolunga laminato bordo abs in tinta sp. 2 cm "LUNCH+39" PULL-OUT BASE UNIT WITH PULL-OUT WORKING WORKTOP Extension laminate matching abs edge th. 2 cm	90	BB90A00
		120	BB12A00
	MAGGIORAZIONE PER PROLUNGA FENIX SP. 2 CM SURCHARGE FOR EXTENSION FENIX TH. 2 CM	90	-
		120	-

**BASI SOSPESSE**

WALL HUNG BASE UNITS

h.39- 40,5 (CON GOLLA - MANGILA LINEAR - MANIGLIA GRIP)
(WITH GROOVE - LINEAR HANDLE - GRIP HANDLE) /p.34

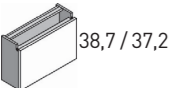
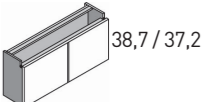
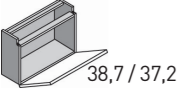
STRUTTURA STRUCTURE	DESCRIZIONE DESCRIPTION	LARGH. (cm) WIDTH (cm)	CODICE CODE
	FASCIA TAMPONAMENTO FILLER	3/15	BM00B00
	BASE 1 ANTA BASE UNIT 1 DOOR	45	BT45B05
		60	BT60B05
	BASE 2 ANTE BASE UNIT 2 DOORS	90	BT90B05
	BASE 1 ANTA RIBALTA BASE UNIT 1 DOOR OPEN FLAP	45	BR45B05
		60	BR60B05
		NEW 75	BR75B05
		90	BR90B05
		NEW 105	BR10B05
		120	BR12B05



Per colorazioni disponibili per i piani Fenix e Laminato vedi listino ELEMENTI UNIVERSALI
For available colors for Fenix and Laminate worktops see UNIVERSAL ELEMENTS price list



Attenzione! posizionare sempre tra due elementi
Attention! always place between two elements

E1	E2	E4
758	760	773
840	843	864
+ 81	+ 81	+ 81
+ 81	+ 81	+ 81

E1	E2	E4
71	73	79
95	98	112
110	114	133
154	160	187
197	200	214
212	216	235
224	230	252
231	238	270
251	261	294
256	266	306

BASI SOSPESSE

WALL HUNG BASE UNITS

h.39-40,5 (CON GOLA - MANGILA LINEAR - MANIGLIA GRIP)
(WITH GROOVE - LINEAR HANDLE - GRIP HANDLE) /p.47

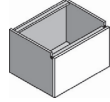
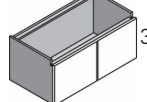
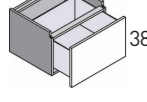
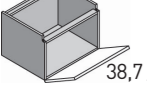
STRUTTURA STRUCTURE	DESCRIZIONE DESCRIPTION	LARGH. (cm) WIDTH (cm)	CODICE CODE
	FASCIA TAMPONAMENTO FILLER	3/15	BM00B00
 38,7 / 37,2	BASE 1 ANTA BASE UNIT 1 DOOR	45	BT45B04
		60	BT60B04
 38,7 / 37,2	BASE 2 ANTE BASE UNIT 2 DOORS	90	BT90B04
 38,7 / 37,2	BASE CESTO ESTRAIBILE BASE UNIT W/PULL-OUT DEEP-PAN DRAWER	45	BD45B03
		60	BD60B03
		75	BD75B03
		90	BD90B03
		105	BD10B03
		120	BD12B03
 38,7 / 37,2	BASE 1 ANTA RIBALTA BASE UNIT 1 DOOR OPEN FLAP	45	BR45B04
		60	BR60B04
		75	BR75B04
		90	BR90B04
		105	BR10B04
		120	BR12B04

E1	E2	E4
71	73	79
107	110	123
118	122	141
165	172	199
173	176	189
186	191	209
208	215	237
220	226	259
273	283	317
278	288	328
208	212	225
220	224	243
235	241	263
243	249	282
260	269	303
262	272	312

BASI SOSPESSE

WALL HUNG BASE UNITS

h.39-40,5 (CON GOLA - MANGILA LINEAR - MANIGLIA GRIP)
(WITH GROOVE - LINEAR HANDLE - GRIP HANDLE) /p.59

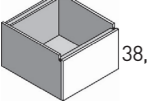
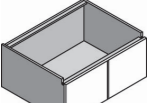
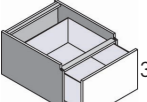
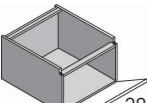
STRUTTURA STRUCTURE	DESCRIZIONE DESCRIPTION	LARGH. (cm) WIDTH (cm)	CODICE CODE
	FASCIA TAMPONAMENTO FILLER	3/15	BM00B00
 38,7 / 37,2	BASE 1 ANTA BASE UNIT 1 DOOR	45	BT45B01
		60	BT60B01
 38,7 / 37,2	BASE 2 ANTE BASE UNIT 2 DOORS	90	BT90B01
 38,7 / 37,2	BASE CESTO ESTRAIBILE BASE UNIT W/PULL-OUT DEEP-PAN DRAWER	45	BD45B00
		60	BD60B00
		NEW 75	BD75B00
		90	BD90B00
		NEW 105	BD10B00
		120	BD12B00
 38,7 / 37,2	BASE 1 ANTA RIBALTA BASE UNIT 1 DOOR OPEN FLAP	45	BR45B03
		60	BR60B03
		NEW 75	BR75B03
		90	BR90B03
		NEW 105	BR10B03
		120	BR12B03

E1	E2	E4
71	73	79
107	110	123
117	121	140
166	173	200
173	176	189
196	200	219
210	217	239
221	227	260
279	288	322
291	302	342
208	212	225
224	228	247
237	243	265
244	250	283
265	275	308
276	286	326

PENSILI

WALL UNITS

h.36 / p.34

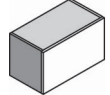
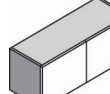
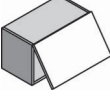
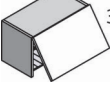
STRUTTURA STRUCTURE	DESCRIZIONE DESCRIPTION	LARGH. (cm) WIDTH (cm)	CODICE CODE
	FASCIA TAMPONAMENTO FILLER	3/15	PA00B00
	PENSILE 1 ANTA WALL UNIT 1 DOOR	45 60	PR45B00 PR60B00
	PENSILE 2 ANTE WALL UNIT 2 DOORS	90 120	PR90B00 PR12B00
	PENSILE VASISTAS WALL UNIT W/LIFT-UP DOOR	45 60 75 90 105 120	PS45B00 PS60B00 PS75B00 PS90B00 PS10B00 PS12B00
	COLAPIATTI VASISTAS, 1 griglia portapiatti e portabicchieri DISH DRAINER UNIT W/LIFT-UP DOOR, 1 plate-rack and glass-rack	60 75 90 120	SS60B00 SS75B00 SS90B00 SS12B00
	Maggiorazione vaschetta inox raccogliocce (vaschetta inox raccogliocce inclusa nel colapiatti da 120) Surcharge steel drip tray (steel tray included in the dish drainer 120)	60 90	- -



Possibilità di inserire a richiesta con maggiorazione il colapiatti DELUXE (vedi articolo alla sezione MAGGIORAZIONI)
Possibility of inserting the DELUXE dish drainer on request with surcharge (see article in the section SURCHARGES)



E1	E2	E4
63	66	72
98	102	114
113	118	133
144	153	176
186	197	226
132	136	147
143	149	163
193	200	222
202	209	233
230	241	268
239	250	278
168	174	188
228	236	258
246	254	277
325	336	364
+ 20	+ 20	+ 20
+ 26	+ 26	+ 26

PENSILI CAPPA

HOOD WALL UNITS

h.36 /p.34

IL PRIMO PREZZO È QUELLO DEL PENSILE CAPPA CON MOTORE "MAGIC" (DI SERIE).
 PER OTTENERE IL PREZZO DEL PENSILE CAPPA CON UN ALTRO MOTORE DIVERSO DAL MAGIC,
 UNO TRA QUELLI DISPONIBILI (OPTIONAL), OCCORRE SOMMARE I PREZZI DI MAGGIORAZIONE.
 THE FIRST PRICE IS THAT OF THE HOOD RACK WITH "MAGIC" MOTOR (STANDARD).
 TO OBTAIN THE PRICE OF THE HOOD ROOF WITH ANOTHER ENGINE DIFFERENT FROM THE MAGIC,
 ONE OF THOSE AVAILABLE (OPTIONAL), IT IS NECESSARY TO SUMMARIZE THE PRICE OF INCREASE.

STRUTTURA STRUCTURE	DESCRIZIONE DESCRIPTION	LARGH. (cm) WIDTH (cm)	CODICE CODE
 	PENSILE CAPPA VASISTAS, motore "MAGIC" Portata Motore 500 M ³ H Illuminazione n° 2 Faretti Per Largh. 60 - 90 cm : Classe Energetica C Per Largh. 75 cm : Classe Energetica A HOOD UNIT W/LIFT-UP DOOR, "MAGIC" motor Engine capacity 500 M ³ H Lighting n° 2 spots For Width 60 - 90 cm : Energy Class C For Width 75 cm : Energy Class A	INOX STAINLESS	60 DZ60B00
		NEW	75 DZ75B00
			90 DZ90B00
OPTIONAL OPTIONAL 	Maggiorazione MOTORE "OPTIMA" Portata Motore 710 M ³ H Illuminazione n° 2 Faretti Classe Energetica A Surcharge "OPTIMA" MOTOR Engine capacity 710 M ³ H Lighting n° 2 spots Energy Class A	INOX STAINLESS	60 -
			90 -
		ANTRACITE ANTHRACITE	60 -
		90 -	
OPTIONAL OPTIONAL 	Maggiorazione MOTORE "FUSION ADVANCED" (Anticondensa) Portata Motore 818 M ³ H Illuminazione Lampada fluorescente Classe Energetica A Surcharge "FUSION ADVANCED" MOTOR (Anticondensation) Engine capacity 818 M ³ H Lighting fluorescent lamp Energy Class A	INOX STAINLESS	60 -
			90 -
		ANTRACITE ANTHRACITE	60 -
		90 -	
OPTIONAL OPTIONAL 	Maggiorazione MOTORE "ILMA" (Anticondensa) Portata Motore 455 M ³ H Illuminazione n° 2 Faretti Classe Energetica A Surcharge "ILMA" MOTOR (Anticondensation) Engine capacity 455 M ³ H Lighting n° 2 spots Energy Class A	INOX STAINLESS	60 -
			90 -
OPTIONAL OPTIONAL 	Maggiorazione MOTORE "SLIVER" (Anticondensa) Portata Motore 620 M ³ H Illuminazione Lampada fluorescente Classe Energetica A Surcharge "SLIVER" MOTOR (Anticondensation) Engine capacity 620 M ³ H Lighting fluorescent lamp Energy Class A	INOX STAINLESS	60 -
		NEW	75 -
			90 -
		ANTRACITE ANTHRACITE	60 -
		NEW	75 -
			90 -

E1	E2	E4
488	493	508
635	642	664
558	565	588
+ 90	+ 90	+ 90
+ 90	+ 90	+ 90
+ 135	+ 135	+ 135
+ 135	+ 135	+ 135
+ 1160	+ 1160	+ 1160
+ 1265	+ 1265	+ 1265
+ 1160	+ 1160	+ 1160
+ 1265	+ 1265	+ 1265
+ 1090	+ 1090	+ 1090
+ 1140	+ 1140	+ 1140
+ 715	+ 715	+ 715
+ 962	+ 962	+ 962
+ 745	+ 745	+ 745
+ 865	+ 865	+ 865
+ 1069	+ 1069	+ 1069
+ 975	+ 975	+ 975

PENSILI

WALL UNITS

h.48 /p.34

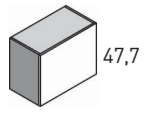
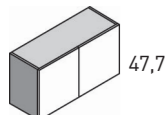
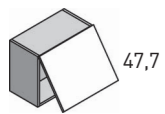
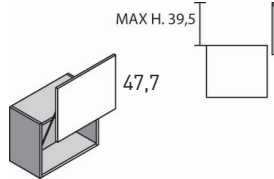
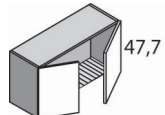
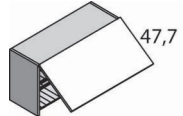
STRUTTURA STRUCTURE	DESCRIZIONE DESCRIPTION	LARGH. (cm) WIDTH (cm)	CODICE CODE
	FASCIA TAMPONAMENTO FILLER	3/15	PA00D00
	PENSILE 1 ANTA, 1 ripiano WALL UNIT 1 DOOR, 1 shelf	45 60	PR45D00 PR60D00
	PENSILE 2 ANTE, 1 ripiano WALL UNIT 2 DOORS, 1 shelf	90 120	PR90D00 PR12D00
	PENSILE VASISTAS, 1 ripiano WALL UNIT W/LIFT-UP DOOR, 1 shelf	45 60 75 90 105 120	PS45D00 PS60D00 PS75D00 PS90D00 PS10D00 PS12D00
	PENSILE VELA, 1 ripiano WALL UNIT W/PULL+SLIDE DOOR, 1 shelf	60 90 105 120	PS60D01 PS90D01 PS10D01 PS12D01
	COLAPIATTI 2 ANTE, 1 griglia portapiatti DISH DRAINER UNIT 2 DOORS, 1 plate-rack	90 120	SR90D00 SR12D00
	Maggiorazione vaschetta inox raccogliogocce (vaschetta inox raccogliogocce inclusa nel colapiatti da 120) Surcharge steel drip tray (steel tray included in the dish drainer 120)	90	-
	COLAPIATTI VASISTAS, 1 griglia portapiatti DISH DRAINER UNIT W/LIFT-UP DOOR, 1 plate-rack	60 75 90 120	SS60D00 SS75D00 SS90D00 SS12D00
	Maggiorazione vaschetta inox raccogliogocce (vaschetta inox raccogliogocce inclusa nel colapiatti da 120) Surcharge steel drip tray (steel tray included in the dish drainer 120)	60 90	- -

E1	E2	E4
67	69	75
104 125	109 130	125 146
171 223	179 231	213 265
143 159 216 228 262 264	147 163 225 241 279 284	164 180 247 264 308 310
308 334 369 385	312 347 384 405	329 370 416 431
220 310	228 319	262 352
+ 26	+ 26	+ 26
188 239 257 341	193 248 269 361	209 270 292 387
+ 20 + 26	+ 20 + 26	+ 20 + 26



Possibilità di inserire a richiesta con maggiorazione il colapiatti DELUXE (vedi articolo alla sezione MAGGIORAZIONI)
Possibility of inserting the DELUXE dish drainer on request with surcharge (see article in the section SURCHARGES)

PENSILI

WALL UNITS

h.48 / p.34

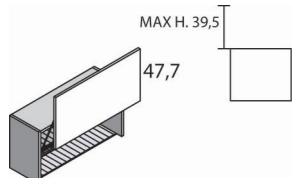
STRUTTURA STRUCTURE	DESCRIZIONE DESCRIPTION	LARGH. (cm) WIDTH (cm)	CODICE CODE	
	COLAPIATTI VELA, 1 griglia portapiatti DISH DRAINER UNIT W/PULL+SLIDE DOOR, 1 plate-rack	60	SS60D01	
		90	SS90D01	
		120	SS12D01	
	Maggiorazione vaschetta inox raccogliocce (vaschetta inox raccogliocce inclusa nel colapiatti da 120) Surcharge steel drip tray (steel tray included in the dish drainer 120)		60	-
		90	-	

**PENSILI CAPPA**

HOOD WALL UNITS

h.48 / p.34

IL PRIMO PREZZO È QUELLO DEL PENSILE CAPPA CON MOTORE "MAGIC" (DI SERIE).
 PER OTTENERE IL PREZZO DEL PENSILE CAPPA CON UN ALTRO MOTORE DIVERSO DAL MAGIC,
 UNO TRA QUELLI DISPONIBILI (OPTIONAL), OCCORRE SOMMARE IL PREZZO DI MAGGIORAZIONE.
 THE FIRST PRICE IS THAT OF THE HOOD RACK WITH "MAGIC" MOTOR (STANDARD).
 TO OBTAIN THE PRICE OF THE HOOD ROOF WITH ANOTHER ENGINE DIFFERENT FROM THE MAGIC,
 ONE OF THOSE AVAILABLE (OPTIONAL), IT IS NECESSARY TO SUMMARIZE THE PRICE OF INCREASE.

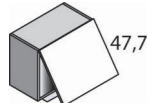
STRUTTURA STRUCTURE	DESCRIZIONE DESCRIPTION	LARGH. (cm) WIDTH (cm)	CODICE CODE
 DI SERIE STANDARD	PENSILE CAPPA VASISTAS, motore "MAGIC" Portata Motore 500 M ³ H Illuminazione n° 2 Faretti Per Largh. 60 - 90 cm : Classe Energetica C Per Largh. 75 cm : Classe Energetica A HOOD UNIT W/LIFT-UP DOOR, "MAGIC" motor Engine capacity 500 M ³ H Lighting n° 2 spots For Width 60 - 90 cm : Energy Class C For Width 75 cm : Energy Class A	60	DZ60D00
		75	DZ75D00
		90	DZ90D00

H. MIN. 52 CM
H. MIN. 52 CMNO TUBO CAPPA
NO HOOD TUBE**OPTIONAL
OPTIONAL****Maggiorazione MOTORE "OPTIMA"**

Portata Motore 710 M³H
 Illuminazione n° 2 Faretti
 Classe Energetica A

Surcharge "OPTIMA" MOTOR
 Engine capacity 710 M³H
 Lighting n° 2 spots
 Energy Class A

H. MIN. 50 CM
H. MIN. 50 CMNO TUBO CAPPA
NO HOOD TUBEINOX
STAINLESS

NEW

INOX
STAINLESSANTRACITE
ANTHRACITE**OPTIONAL
OPTIONAL****Maggiorazione MOTORE "VIRGOLA NO-DROP" (Anticondensa)**

Portata Motore 600 M³H
 Illuminazione n° 2 Faretti
 Classe Energetica C

Surcharge "VIRGOLA NO-DROP" MOTOR (Anticondensation)
 Engine capacity 600 M³H
 Lighting n° 2 spots
 Energy Class C

H. MIN. 52 CM
H. MIN. 52 CMNO TUBO CAPPA
NO HOOD TUBEINOX
STAINLESS

Possibilità di inserire a richiesta con maggiorazione il colapiatti DELUXE (vedi articolo alla sezione MAGGIORAZIONI)
 Possibility of inserting the DELUXE dish drainer on request with surcharge (see article in the section SURCHARGES)

E1	E2	E4
322	326	343
365	377	401
446	466	492
+ 20	+ 20	+ 20
+ 26	+ 26	+ 26

E1	E2	E4
497	501	518
645	655	677
569	581	604

+ 90	+ 90	+ 90
+ 90	+ 90	+ 90







+ 135	+ 135	+ 135
+ 135	+ 135	+ 135

+ 695	+ 695	+ 695
+ 735	+ 735	+ 735

PENSILI CAPPA

HOOD WALL UNITS

h.48 /p.34

STRUTTURA STRUCTURE	DESCRIZIONE DESCRIPTION	LARGH. (cm) WIDTH (cm)	CODICE CODE
OPTIONAL OPTIONAL	Maggiorazione MOTORE "FUSION ADVANCED" (Anticondensa) Portata Motore 818 M ³ H Illuminazione Lampada fluorescente Classe Energetica A Surcharge "FUSION ADVANCED" MOTOR (Anticondensation) Engine capacity 818 M ³ H Lighting fluorescent lamp Energy Class A	INOX STAINLESS 60	-
		90	-
	Surcharge "FUSION ADVANCED" MOTOR (Anticondensation) Engine capacity 818 M ³ H Lighting fluorescent lamp Energy Class A	ANTRACITE ANTHRACITE 60	-
		90	-
	H. MIN. 65 CM (PIANO COTTURA GAS) H. MIN. 65 CM (GAS COOKER) H. MIN. 50 CM (PC ELETTRICO INDUZIONE, P.C. CERAMICA) H. MIN. 50 CM (ELECTRIC INDUCTION HOOD, CERAMIC HOOD) NO TUBO CAPPA NO HOOD TUBE		
OPTIONAL OPTIONAL	Maggiorazione MOTORE "ILMA" (Anticondensa) Portata Motore 455 M ³ H Illuminazione n° 2 Faretto Classe Energetica A Surcharge "ILMA" MOTOR (Anticondensation) Engine capacity 455 M ³ H Lighting n° 2 spots Energy Class A	INOX STAINLESS 60	-
		90	-
	Surcharge "ILMA" MOTOR (Anticondensation) Engine capacity 455 M ³ H Lighting n° 2 spots Energy Class A		
	H. MIN. 50 CM H. MIN. 50 CM NO TUBO CAPPA NO HOOD TUBE		
OPTIONAL OPTIONAL	Maggiorazione MOTORE "IN-NOVA" Portata Motore 670 M ³ H Illuminazione n° 2 Faretto Classe Energetica A Surcharge "IN-NOVA" MOTOR Engine capacity 670 M ³ H Lighting n° 2 spots Energy Class A	INOX STAINLESS 60	-
		90	-
	Surcharge "IN-NOVA" MOTOR Engine capacity 670 M ³ H Lighting n° 2 spots Energy Class A		
	H. MIN. 53 CM H. MIN. 53 CM NO TUBO CAPPA NO HOOD TUBE		
OPTIONAL OPTIONAL	Maggiorazione MOTORE "SLIVER" (Anticondensa) Portata Motore 620 M ³ H Illuminazione Lampada fluorescente Classe Energetica A Surcharge "SLIER" MOTOR (Anticondensation) Engine capacity 620 M ³ H Lighting fluorescent lamp Energy Class A	INOX STAINLESS 60	-
		75	-
	Surcharge "SLIER" MOTOR (Anticondensation) Engine capacity 620 M ³ H Lighting fluorescent lamp Energy Class A	90	-
	H. MIN. 45 CM H. MIN. 45 CM NO TUBO CAPPA NO HOOD TUBE		
	H. MIN. 45 CM H. MIN. 45 CM NO TUBO CAPPA NO HOOD TUBE	60	-
		75	-
	H. MIN. 45 CM H. MIN. 45 CM NO TUBO CAPPA NO HOOD TUBE	90	-

E1	E2	E4
+ 1160	+ 1160	+ 1160
+ 1265	+ 1265	+ 1265
+ 1160	+ 1160	+ 1160
+ 1265	+ 1265	+ 1265
+ 1090	+ 1090	+ 1090
+ 1140	+ 1140	+ 1140
+ 365	+ 365	+ 365
+ 395	+ 395	+ 395
+ 715	+ 715	+ 715
+ 962	+ 962	+ 962
+ 745	+ 745	+ 745
+ 865	+ 865	+ 865
+ 1069	+ 1069	+ 1069
+ 975	+ 975	+ 975

PENSILI

WALL UNITS

h.60 /p.34

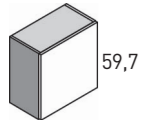
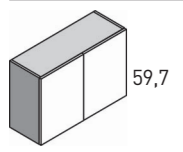
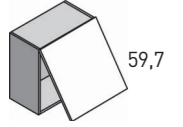
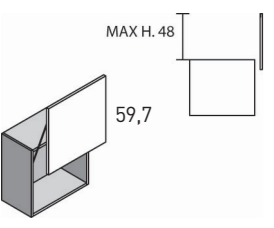
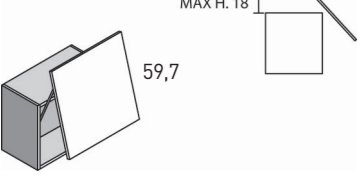
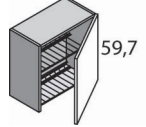
STRUTTURA STRUCTURE	DESCRIZIONE DESCRIPTION	LARGH. (cm) WIDTH (cm)	CODICE CODE
	FASCIA TAMPONAMENTO FILLER	3/15	PA00F00
	PENSILE 1 ANTA, 1 ripiano WALL UNIT 1 DOOR, 1 shelf	45	PR45F00
		60	PR60F00
	PENSILE 2 ANTE, 1 ripiano WALL UNIT 2 DOORS, 1 shelf	90	PR90F00
		120	PR12F00
	PENSILE VASISTAS, 1 ripiano WALL UNIT W/LIFT-UP DOOR, 1 shelf	60	PS60F00
		NEW 75	PS75F00
		90	PS90F00
		NEW 105	PS10F00
		120	PS12F00
	PENSILE VELA, 1 ripiano WALL UNIT W/PULL+SLIDE DOOR, 1 shelf	60	PS60F01
		90	PS90F01
	PENSILE BASCULANTE, 1 ripiano WALL UNIT W/UP & OVER DOOR, 1 shelf	60	PS60F02
		NEW 75	PS75F01
		90	PS90F02
		NEW 105	PS10F01
		120	PS12F02
	COLAPIATTI 1 ANTA, 1 griglia portapiatti 1 griglia portabicchieri DISH DRAINER UNIT 1 DOOR, 1 plate-rack, 1 glass-rack	45	SR45F00
		60	SR60F00
	Maggiorazione vaschetta inox raccogliocce Surcharge steel drip tray	45	-
		60	-



E1	E2	E4
71	73	79
120	123	143
131	139	157
186	193	233
248	265	301
170	178	196
231	242	272
244	257	285
282	298	339
288	310	345
308	317	334
345	357	386
302	310	328
324	334	365
334	347	375
387	403	444
390	412	447
165	168	188
181	189	207
+ 20	+ 20	+ 20
+ 20	+ 20	+ 20







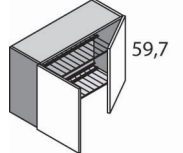

Possibilità di inserire a richiesta con maggiorazione il colapiatti DELUXE (vedi articolo alla sezione MAGGIORAZIONI)
Possibility of inserting the DELUXE dish drainer on request with surcharge (see article in the section SURCHARGES)

PENSILI

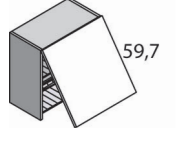
WALL UNITS

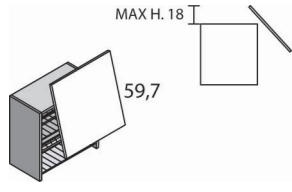
h.60 /p.34

STRUTTURA STRUCTURE	DESCRIZIONE DESCRIPTION	LARGH. (cm) WIDTH (cm)	CODICE CODE
	COLAPIATTI 2 ANTE, 1 griglia portapiatti 1 griglia portabicchieri DISH DRAINER UNIT 2 DOORS, 1 plate-rack, 1 glass-rack	90	SR90F00
		120	SR12F00
	Maggiorazione vaschetta inox raccogliogocce (vaschetta inox raccogliogocce inclusa nel colapiatti da 120) Surcharge steel drip tray (steel tray included in the dish drainer 120)	60	-
		90	-
			
	COLAPIATTI VASISTAS, 1 griglia portapiatti 1 griglia portabicchieri DISH DRAINER UNIT W/LIFT-UP DOOR, 1 plate-rack, 1 glass-rack	60	SS60F00
		75	SS75F00
		90	SS90F00
		120	SS12F00
	Maggiorazione vaschetta inox raccogliogocce (vaschetta inox raccogliogocce inclusa nel colapiatti da 120) Surcharge steel drip tray (steel tray included in the dish drainer 120)	60	-
		90	-
			
	COLAPIATTI BASCULANTE, 1 griglia portapiatti, 1 griglia portabicchieri DISH DRAINER UNIT W/UP & OVER DOOR, 1 plate-rack, 1 glass-rack	60	SS60F02
		75	SS75F01
		90	SS90F02
		120	SS12F02
	Maggiorazione vaschetta inox raccogliogocce (vaschetta inox raccogliogocce inclusa nel colapiatti da 120) Surcharge steel drip tray (steel tray included in the dish drainer 120)	60	-
		90	-
			
			

E1	E2	E4
254	260	300
360	376	412
+ 20	+ 20	+ 20
+ 26	+ 26	+ 26
213	221	239
288	299	329
290	303	331
389	411	446
+ 20	+ 20	+ 20
+ 26	+ 26	+ 26
345	353	371
381	391	422
390	403	431
486	508	542
+ 20	+ 20	+ 20
+ 26	+ 26	+ 26









Possibilità di inserire a richiesta con maggiorazione il colapiatti DELUXE (vedi articolo alla sezione MAGGIORAZIONI)
Possibility of inserting the DELUXE dish drainer on request with surcharge (see article in the section SURCHARGES)

PENSILI CAPPA

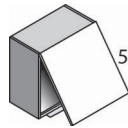
HOOD WALL UNITS

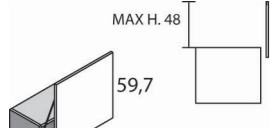
h.60 / p.34

IL PRIMO PREZZO È QUELLO DEL PENSILE CAPPA CON MOTORE "MAGIC" (DI SERIE).
PER OTTENERE IL PREZZO DEL PENSILE CAPPA CON UN ALTRO MOTORE DIVERSO DAL MAGIC,
UNO TRA QUELLI DISPONIBILI (OPTIONAL), OCCORRE SOMMARE I PREZZO DI MAGGIORAZIONE.
THE FIRST PRICE IS THAT OF THE HOOD RACK WITH "MAGIC" MOTOR (STANDARD).
TO OBTAIN THE PRICE OF THE HOOD ROOF WITH ANOTHER ENGINE DIFFERENT FROM THE MAGIC,
ONE OF THOSE AVAILABLE (OPTIONAL), IT IS NECESSARY TO SUMMARIZE THE PRICE OF INCREASE.

STRUTTURA STRUCTURE	DESCRIZIONE DESCRIPTION	LARGH. (cm) WIDTH (cm)	CODICE CODE
 59,7 DI SERIE STANDARD 	PENSILE CAPPA VASISTAS, motore "MAGIC" Portata Motore 500 M ³ H Illuminazione n° 2 Faretti Per Largh.60 - 90 cm : Classe Energetica C Per Largh. 75 cm : Classe Energetica A HOOD UNIT W/LIFT-UP DOOR, "MAGIC" motor Engine capacity 500 M ³ H Lighting n° 2 spots For Width 60 - 90 cm : Energy Class C For Width 75 cm : Energy Class A	INOX STAINLESS	60 DZ60F00
		NEW	75 DZ75F00
			90 DZ90F00
			120 DZ12F00
 59,7 MAX H. 48 DI SERIE STANDARD 	PENSILE CAPPA VELA, MOTORE "MAGIC" Portata Motore 500 M ³ H Illuminazione n° 2 Faretti Classe Energetica C HOOD UNIT W/PULL+SLIDE DOOR, "MAGIC" MOTOR Engine capacity 500 M ³ H Lighting n° 2 spots Energy Class C	INOX STAINLESS	90 DZ90F01
			120 DZ12F01
OPTIONAL OPTIONAL 	Maggiorazione MOTORE "OPTIMA" Portata Motore 710 M ³ H Illuminazione n° 2 Faretti Classe Energetica A Surcharge "OPTIMA" MOTOR Engine capacity 710 M ³ H Lighting n° 2 spots Energy Class A	INOX STAINLESS	60 -
			90 -
			120 -
		ANTRACITE ANTHRACITE	60 -
			90 -
			120 -
OPTIONAL OPTIONAL 	Maggiorazione MOTORE "VIRGOLA NO-DROP" (Anticondensa) Portata Motore 600 M ³ H Illuminazione n° 2 Faretti Classe Energetica C Surcharge "VIRGOLA NO-DROP" MOTOR (Anticondensation) Engine capacity 600 M ³ H Lighting n° 2 spots Energy Class C	INOX STAINLESS	60 -
			90 -
			120 -
OPTIONAL OPTIONAL 	Maggiorazione MOTORE "FUSION ADVANCED" (Anticondensa) Portata Motore 818 M ³ H Illuminazione Lampada fluorescente Classe Energetica A Surcharge "FUSION ADVANCED" MOTOR (Anticondensation) Engine capacity 818 M ³ H Lighting fluorescent lamp Energy Class A	INOX STAINLESS	60 -
			90 -
			120 -
		ANTRACITE ANTHRACITE	60 -
			90 -
			120 -

E1	E2	E4
538	546	564
680	690	721
618	630	659
698	720	754
708	721	749
797	819	854
+ 90	+ 90	+ 90
+ 90	+ 90	+ 90
+ 90	+ 90	+ 90
+ 135	+ 135	+ 135
+ 135	+ 135	+ 135
+ 135	+ 135	+ 135
+ 695	+ 695	+ 695
+ 735	+ 735	+ 735
+ 865	+ 865	+ 865
+ 1160	+ 1160	+ 1160
+ 1265	+ 1265	+ 1265
+ 1495	+ 1495	+ 1495
+ 1160	+ 1160	+ 1160
+ 1265	+ 1265	+ 1265
+ 1495	+ 1495	+ 1495

PENSILI CAPPA

HOOD WALL UNITS

h.60 /p.34

IL PRIMO PREZZO È QUELLO DEL PENSILE CAPPA CON MOTORE "MAGIC" (DI SERIE).
 PER OTTENERE IL PREZZO DEL PENSILE CAPPA CON UN ALTRO MOTORE DIVERSO DAL MAGIC,
 UNO TRA QUELLI DISPONIBILI (OPTIONAL), OCCORRE SOMMARE I PREZZO DI MAGGIORAZIONE.
 THE FIRST PRICE IS THAT OF THE HOOD RACK WITH "MAGIC" MOTOR (STANDARD).
 TO OBTAIN THE PRICE OF THE HOOD ROOF WITH ANOTHER ENGINE DIFFERENT FROM THE MAGIC,
 ONE OF THOSE AVAILABLE (OPTIONAL), IT IS NECESSARY TO SUMMARIZE THE PRICE OF INCREASE.

STRUTTURA STRUCTURE	DESCRIZIONE DESCRIPTION	LARGH. (cm) WIDTH (cm)	CODICE CODE
OPTIONAL OPTIONAL  	Maggiorazione MOTORE "ILMA" (Anticondensa) Portata Motore 455 M ³ H Illuminazione n° 2 Faretti Classe Energetica A Surcharge "ILMA" MOTOR (Anticondensation) Engine capacity 455 M ³ H Lighting n° 2 spots Energy Class A  H. MIN. 50 CM H. MIN. 50 CM  NO TUBO CAPPA NO HOOD TUBE	INOX STAINLESS	
		60	-
		90	-
		120	-
OPTIONAL OPTIONAL 	Maggiorazione MOTORE "IN-NOVA" Portata Motore 670 M ³ H Illuminazione n° 2 Faretti Classe Energetica A Surcharge "IN-NOVA" MOTOR Engine capacity 670 M ³ H Lighting n° 2 spots Energy Class A  H. MIN. 53 CM H. MIN. 53 CM  NO TUBO CAPPA NO HOOD TUBE	INOX STAINLESS	
		60	-
		90	-
		120	-
OPTIONAL OPTIONAL  	Maggiorazione MOTORE "SLIVER" (Anticondensa) Portata Motore 620 M ³ H Illuminazione Lampada fluorescente Classe Energetica A Surcharge "SLIVER" MOTOR (Anticondensation) Engine capacity 620 M ³ H Lighting fluorescent lamp Energy Class A  H. MIN. 45 CM H. MIN. 45 CM  NO TUBO CAPPA NO HOOD TUBE	INOX STAINLESS	
		60	-
		NEW 75	-
		90	-
		120	-
		ANTRACITE ANTHRACITE	
		NEW 60	-
		75	-
90	-		
120	-		

E1	E2	E4
+ 1090	+ 1090	+ 1090
+ 1140	+ 1140	+ 1140
+ 1270	+ 1270	+ 1270
+ 365	+ 365	+ 365
+ 395	+ 395	+ 395
+ 435	+ 435	+ 435
+ 715	+ 715	+ 715
+ 962	+ 962	+ 962
+ 745	+ 745	+ 745
+ 875	+ 875	+ 875
+ 865	+ 865	+ 865
+ 1069	+ 1069	+ 1069
+ 975	+ 975	+ 975
+ 1115	+ 1115	+ 1115

PENSILI

WALL UNITS

h.72 /p.34

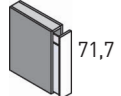
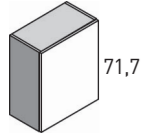
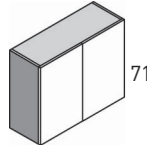
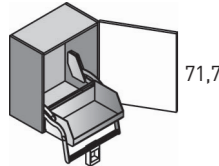
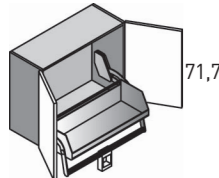
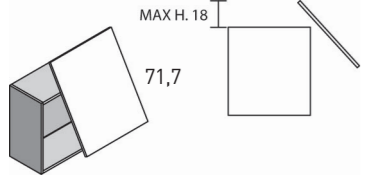
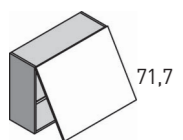
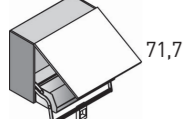
STRUTTURA STRUCTURE	DESCRIZIONE DESCRIPTION	LARGH. (cm) WIDTH (cm)	CODICE CODE
	FASCIA TAMPONAMENTO FILLER	3/15	PA00H00
	PENSILE ESTRAIBILE PULL-OUT WALL UNIT	15	PD15H00
	PENSILE 1 ANTA, 1 ripiano WALL UNIT 1 DOOR, 1 shelf	15	PR15H00
		30	PR30H00
		40	PR40H00
		45	PR45H00
		60	PR60H00
		NEW NEW	65 75
	PENSILE 2 ANTE, 1 ripiano WALL UNIT 2 DOORS, 1 shelf	60	PR60H03
		80	PR80H00
		90	PR90H00
	PENSILE 1 ANTA, 1 ripiano "Sali/Scendi" colore antracite WALL UNIT 1 DOOR, 1 shelf "Up / Down" anthracite color	60	PR60H07
	PENSILE 2 ANTE, 1 ripiano "Sali/Scendi" colore antracite WALL UNIT 2 DOORS, 1 shelf "Up / Down" anthracite color	90	PR90H01
	PENSILE BASCULANTE, 1 ripiano WALL UNIT W/UP & OVER DOOR, 1 shelf	90	PS90H00
	PENSILE VASISTAS, 1 ripiano WALL UNIT W/LIFT-UP DOOR, 1 shelf	90	PS90H03
	PENSILE VASISTAS, 1 ripiano "Sali/Scendi" colore antracite WALL UNIT W/LIFT-UP DOOR, 1 shelf "Up / Down" anthracite color	90	PS90H05

E1	E2	E4
76	78	84
152	155	163
98	101	110
107	111	129
115	120	141
123	129	152
137	147	171
152	162	207
176	192	225
161	170	205
176	186	228
187	198	244
690	701	724
773	784	830
357	375	407
260	278	309
818	836	868

PENSILI

WALL UNITS

h.72 /p.34

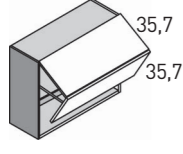
STRUTTURA STRUCTURE	DESCRIZIONE DESCRIPTION	LARGH. (cm) WIDTH (cm)	CODICE CODE	
	PENSILE SOFFIETTO, 1 ripiano WALL UNIT W/FOLDING DOOR, 1 shelf		PF60H01	
		NEW	75	PF75H00
			90	PF90H02
		NEW	105	PF10H00
			120	PF12H00

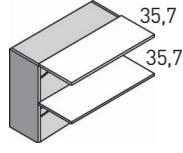
	PENSILE 2 VASISTAS WALL UNIT 2 LIFT-UP DOORS		PS60H00	
		NEW	75	PS75H00
			90	PS90H02
		NEW	105	PS10H00
			120	PS12H01

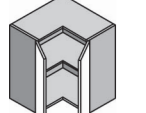

	PENSILE ANGOLO 90°, 1 ripiano Anta H. 71,7 x L. 28 cm + Anta H. 71,7 x L. 29,7 cm (65 x 65) 90° CORNER WALL UNIT UNIT, 1 schelf Door H 71,7 x W 28 cm + Door H 71,7 x W 29,7 cm (65 x 65)	65x65	PH65H00
---	---	--------------	---------

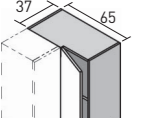
	PENSILE ANGOLO CON TAPPO, 1 ripiano Anta H. 71,7 x L. 27,65 cm CORNER WALL UNIT UNIT WITH CAP, 1 schelf Door H 71,7 x W 27,65 cm	65x37	PT65H00
--	--	--------------	---------



E1	E2	E4
364	374	404
370	385	429
415	430	476
455	476	531
478	501	556

254	264	293
340	354	398
364	378	425
410	431	486
434	457	512

276	282	327
-----	-----	-----

268	273	294
-----	-----	-----









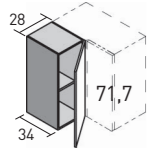
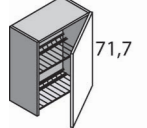

Considerare maggiorazione per ante con apertura Premi/Apri per elemento abbinato a moduli con gola + 25 PTS.
Consider surcharge for doors with Push/Pull opening for element combined to modules with groove + 25 PTS.

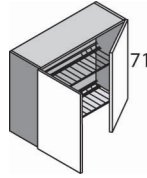
PENSILI

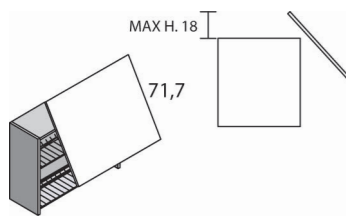
WALL UNITS

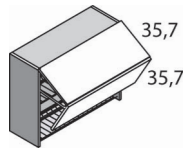
h.72 /p.34

STRUTTURA STRUCTURE	DESCRIZIONE DESCRIPTION	LARGH. (cm) WIDTH (cm)	CODICE CODE
	PENSILE 1 ANTA IN ACCOSTO AL PENSILE ANGOLO CON TAPPO, 1 ripiano Anta H. 71,7 x L. 27,65 cm WALL UNIT 1 DOOR ADJACENT FORCORNER WALL UNIT WITH CAP, 1 shelf Door H 71,7 x W 27,65 cm	28	PR28H00
	COLAPIATTI 1 ANTA, 1 griglia portapiatti 1 griglia portabicchieri DISH DRAINER UNIT 1 DOOR, 1 plate-rack, 1 glass-rack	45 60 75	SR45H00 SR60H00 SR75H00
	Maggiorazione vaschetta inox raccogliogocce Surcharge steel drip tray	45 60	- -
			
	COLAPIATTI 2 ANTE, 1 griglia portapiatti 1 griglia portabicchieri DISH DRAINER UNIT 2 DOORS, 1 plate-rack, 1 glass-rack	80 90	SR80H00 SR90H00
	Maggiorazione vaschetta inox raccogliogocce Surcharge steel drip tray	80 90	- -
			
	COLAPIATTI BASCULANTE, 1 griglia portapiatti 1 griglia portabicchieri DISH DRAINER UNIT W/UP & OVER DOOR, 1 plate-rack, 1 glass-rack	90	SS90H00
	Maggiorazione vaschetta inox raccogliogocce Surcharge steel drip tray	90	-
			
	COLAPIATTI SOFFIETTO, 1 griglia portapiatti 1 griglia portabicchieri DISH DRAINER UNIT W/FOLDING DOOR, 1 plate-rack, 1 glass-rack	60 75 90 120	SF60H00 SF75H00 SF90H00 SF12H00
	Maggiorazione vaschetta inox raccogliogocce (vaschetta inox raccogliogocce inclusa nel colapiatti da 120) Surcharge steel drip tray (steel tray included in the dish drainer 120)	60 90	- -
			

E1	E2	E4
110	112	129
174	179	202
193	203	226
245	261	294
+ 20	+ 20	+ 20
+ 20	+ 20	+ 20
252	263	305
262	272	319
+ 26	+ 26	+ 26
+ 26	+ 26	+ 26
405	423	454
+ 26	+ 26	+ 26
399	410	439
427	441	486
446	460	507
562	585	640
+ 20	+ 20	+ 20
+ 26	+ 26	+ 26







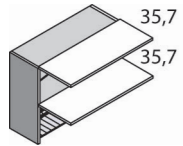

Possibilità di inserire a richiesta con maggiorazione il colapiatti DELUXE (vedi articolo alla sezione MAGGIORAZIONI)
Possibility of inserting the DELUXE dish drainer on request with surcharge (see article in the section SURCHARGES)

PENSILI

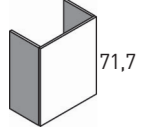
WALL UNITS

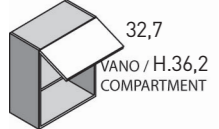
h.72 / p.34

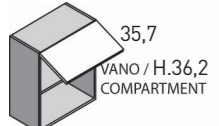
STRUTTURA STRUCTURE	DESCRIZIONE DESCRIPTION	LARGH. (cm) WIDTH (cm)	CODICE CODE	
	COLAPIATTI 2 VASISTAS, 1 ripiano 1 griglia unica portapiatti DISH DRAINER UNIT W/2 LIFT-UP DOORS, 1 shelf 1 single plate-rack Maggiorazione vaschetta inox raccogli gocce (vaschetta inox raccogli gocce inclusa nel colapiatti da 120) Surcharge steel drip tray (steel tray included in the dish drainer 120)  	60	SS60H00	
		75	SS75H00	
		90	SS90H01	
		120	SS12H01	
		60	-	
		90	-	
	COPRIBOILER 1 ANTA BOILER HOUSING 1 DOOR 	Prof.34 Depth 34	60	PR60H01
		Prof.45 Depth 45	60	PR60H02
	PENSILE VASISTAS E VANO PER MICROONDE WALL UNIT LIFT-UP DOORS AND COMPARTMENT FOR MICROWAVE 		60	PW60H01
	PENSILE VASISTAS E VANO PER MICROONDE WHIRLPOOL WALL UNIT LIFT-UP DOORS AND COMPARTMENT FOR MICROWAVE WHIRLPOOL		60	PW60H00

E1	E2	E4
279	289	319
375	390	434
411	426	472
504	528	582
+ 20	+ 20	+ 20
+ 26	+ 26	+ 26
112	122	151
134	144	167
158	160	183
161	166	181



Considerare maggiorazione per ante con apertura Premi/Apri per elemento abbinato a moduli con gola + 25 PTS.
 Consider surcharge for doors with Push/Pull opening for element combined to modules with groove + 25 PTS.













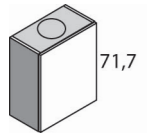



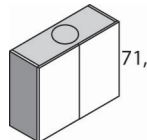

Possibilità di inserire a richiesta con maggiorazione il colapiatti DELUXE (vedi articolo alla sezione MAGGIORAZIONI)
 Possibility of inserting the DELUXE dish drainer on request with surcharge [see article in the section SURCHARGES]

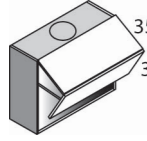
PENSILI CAPPA

HOOD WALL UNITS

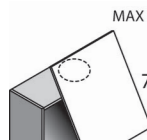
h.72 /p.34

IL PRIMO PREZZO È QUELLO DEL PENSILE CAPPA CON MOTORE "MAGIC" (DI SERIE).
PER OTTENERE IL PREZZO DEL PENSILE CAPPA CON UN ALTRO MOTORE DIVERSO DAL MAGIC,
UNO TRA QUELLI DISPONIBILI (OPTIONAL), OCCORRE SOMMARE I PREZZI DI MAGGIORAZIONE.
THE FIRST PRICE IS THAT OF THE HOOD RACK WITH "MAGIC" MOTOR (STANDARD).
TO OBTAIN THE PRICE OF THE HOOD ROOF WITH ANOTHER ENGINE DIFFERENT FROM THE MAGIC,
ONE OF THOSE AVAILABLE (OPTIONAL), IT IS NECESSARY TO SUMMARIZE THE PRICE OF INCREASE.

STRUTTURA STRUCTURE	DESCRIZIONE DESCRIPTION	LARGH. (cm) WIDTH (cm)	CODICE CODE
 71,7 DI SERIE STANDARD 	PENSILE CAPPA 1 ANTA, motore "MAGIC" Portata Motore 500 M ³ H Illuminazione n° 2 Faretti Per Largh. 60 cm : Classe Energetica C Per Largh. 75 cm : Classe Energetica A HOOD UNIT 1 DOOR, "MAGIC" motor Engine capacity 500 M ³ H Lighting n° 2 spots For Width 60 cm : Energy Class C For Width 75 cm : Energy Class A  H. MIN. 52 CM  NO TUBO CAPPA NO HOOD TUBE	INOX STAINLESS	60 DZ60H00
			75 DZ75H00
 71,7 DI SERIE STANDARD 	PENSILE CAPPA 2 ANTE, MOTORE "MAGIC" Portata Motore 500 M ³ H Illuminazione n° 2 Faretti Classe Energetica C HOOD UNIT 2 DOORS, "MAGIC" MOTOR Engine capacity 500 M ³ H Lighting n° 2 spots Energy Class C  H. MIN. 52 CM  NO TUBO CAPPA NO HOOD TUBE	INOX STAINLESS	90 DZ90H03
			120 DZ12H02
 35,7 35,7 DI SERIE STANDARD 	PENSILE CAPPA SOFFIETTO, motore "MAGIC" Portata Motore 500 M ³ H Illuminazione n° 2 Faretti Per Largh. 60 - 90 - 120 cm : Classe Energetica C Per Largh. 75 cm : Classe Energetica A HOOD UNIT W/FOLDING DOOR, "MAGIC" motor Engine capacity 500 M ³ H Lighting n° 2 spots For Width 60 - 90 - 120 cm : Energy Class C For Width 75 cm : Energy Class A  H. MIN. 52 CM  NO TUBO CAPPA NO HOOD TUBE	INOX STAINLESS	60 DZ60H01
			75 DZ75H01
		90 DZ90H00	
		120 DZ12H00	
 MAX H. 18 71,7 DI SERIE STANDARD 	PENSILE CAPPA BASCULANTE, MOTORE "MAGIC" Portata Motore 500 M ³ H Illuminazione n° 2 Faretti Classe Energetica C HOOD UNIT W/UP&OVER DOOR, "MAGIC" MOTOR Engine capacity 500 M ³ H Lighting n° 2 spots Energy Class C  NO ELEMENTO SOVRAPPONIBILE NOT OVERLAPPING ITEM  H. MIN. 52 CM  NO TUBO CAPPA NO HOOD TUBE	INOX STAINLESS	90 DZ90H02

E1	E2	E4
511	521	544
621	637	670
584	595	641
674	695	741
711	722	751
815	830	874
760	774	821
871	894	949
726	744	775

PENSILI CAPPA

HOOD WALL UNITS

h.72 / p.34

IL PRIMO PREZZO È QUELLO DEL PENSILE CAPPA CON MOTORE "MAGIC" (DI SERIE).
 PER OTTENERE IL PREZZO DEL PENSILE CAPPA CON UN ALTRO MOTORE DIVERSO DAL MAGIC,
 UNO TRA QUELLI DISPONIBILI (OPTIONAL), OCCORRE SOMMARE I PREZZI DI MAGGIORAZIONE.
 THE FIRST PRICE IS THAT OF THE HOOD RACK WITH "MAGIC" MOTOR (STANDARD).
 TO OBTAIN THE PRICE OF THE HOOD ROOF WITH ANOTHER ENGINE DIFFERENT FROM THE MAGIC,
 ONE OF THOSE AVAILABLE (OPTIONAL), IT IS NECESSARY TO SUMMARIZE THE PRICE OF INCREASE.

STRUTTURA STRUCTURE	DESCRIZIONE DESCRIPTION	LARGH. (cm) WIDTH (cm)	CODICE CODE
 <p>DI SERIE STANDARD</p> 	PENSILE CAPPA 2 VASISTAS, motore "MAGIC" Portata Motore 500 M ³ H Illuminazione n° 2 Faretti Per Largh. 60 - 90 - 120 cm : Classe Energetica C Per Largh. 75 cm : Classe Energetica A HOOD UNIT W/2 LIFT-UP DOORS, "MAGIC" motor Engine capacity 500 M ³ H Lighting n° 2 spots For Width 60 - 90 - 120 cm : Energy Class C For Width 75 cm : Energy Class A	INOX STAINLESS	60 DZ60H02
		NEW	75 DZ75H02
		90 DZ90H01	
		120 DZ12H01	
<p>OPTIONAL OPTIONAL</p> 	Maggiorazione MOTORE "OPTIMA" Portata Motore 710 M ³ H Illuminazione n° 2 Faretti Classe Energetica A Surcharge "OPTIMA" MOTOR Engine capacity 710 M ³ H Lighting n° 2 spots Energy Class A	INOX STAINLESS	60 -
		90 -	
		120 -	
		ANTRACITE ANTHRACITE	60 -
		90 -	
		120 -	
<p>OPTIONAL OPTIONAL</p> 	Maggiorazione MOTORE "VIRGOLA NO-DROP" (Anticondensa) Portata Motore 600 M ³ H Illuminazione n° 2 Faretti Classe Energetica C Surcharge "VIRGOLA NO-DROP" MOTOR (Anticondensation) Engine capacity 600 M ³ H Lighting n° 2 spots Energy Class C	INOX STAINLESS	60 -
		90 -	
		120 -	
		ANTRACITE ANTHRACITE	60 -
		90 -	
		120 -	
<p>OPTIONAL OPTIONAL</p> 	Maggiorazione MOTORE "FUSION ADVANCED" (Anticondensa) Portata Motore 818 M ³ H Illuminazione Lampada fluorescente Classe Energetica A Surcharge "FUSION ADVANCED" MOTOR (Anticondensation) Engine capacity 818 M ³ H Lighting fluorescent lamp Energy Class A	INOX STAINLESS	60 -
		90 -	
		120 -	
		ANTRACITE ANTHRACITE	60 -
		90 -	
		120 -	
<p>OPTIONAL OPTIONAL</p> 	Maggiorazione MOTORE "ILMA" (Anticondensa) Portata Motore 455 M ³ H Illuminazione n° 2 Faretti Classe Energetica A Surcharge "ILMA" MOTOR (Anticondensation) Engine capacity 455 M ³ H Lighting n° 2 spots Energy Class A	INOX STAINLESS	60 -
		90 -	
		120 -	
		ANTRACITE ANTHRACITE	60 -
		90 -	
		120 -	

E1	E2	E4
587	598	627
786	801	845
714	729	775
792	815	870
+ 90	+ 90	+ 90
+ 90	+ 90	+ 90
+ 90	+ 90	+ 90
+ 135	+ 135	+ 135
+ 135	+ 135	+ 135
+ 135	+ 135	+ 135
+ 695	+ 695	+ 695
+ 735	+ 735	+ 735
+ 865	+ 865	+ 865
+ 1160	+ 1160	+ 1160
+ 1265	+ 1265	+ 1265
+ 1495	+ 1495	+ 1495
+ 1160	+ 1160	+ 1160
+ 1265	+ 1265	+ 1265
+ 1495	+ 1495	+ 1495
+ 1090	+ 1090	+ 1090
+ 1140	+ 1140	+ 1140
+ 1270	+ 1270	+ 1270









Considerare maggiorazione per ante con apertura Premi/Apri per elemento abbinato a moduli con gola + 25 PTS.
 Consider surcharge for doors with Push/Pull opening for element combined to modules with groove + 25 PTS.

PENSILI CAPPA

HOOD WALL UNITS

h.72 /p.34

IL PRIMO PREZZO È QUELLO DEL PENSILE CAPPA CON MOTORE "MAGIC" (DI SERIE).
 PER OTTENERE IL PREZZO DEL PENSILE CAPPA CON UN ALTRO MOTORE DIVERSO DAL MAGIC,
 UNO TRA QUELLI DISPONIBILI (OPTIONAL), OCCORRE SOMMARE I PREZZO DI MAGGIORAZIONE.
 THE FIRST PRICE IS THAT OF THE HOOD RACK WITH "MAGIC" MOTOR (STANDARD).
 TO OBTAIN THE PRICE OF THE HOOD ROOF WITH ANOTHER ENGINE DIFFERENT FROM THE MAGIC,
 ONE OF THOSE AVAILABLE (OPTIONAL), IT IS NECESSARY TO SUMMARIZE THE PRICE OF INCREASE.







STRUTTURA STRUCTURE	DESCRIZIONE DESCRIPTION	LARGH. (cm) WIDTH (cm)	CODICE CODE
OPTIONAL OPTIONAL 	Maggiorazione MOTORE "IN-NOVA" Portata Motore 670 M ³ H Illuminazione n° 2 Faretto Classe Energetica A Surcharge "IN-NOVA" MOTOR Engine capacity 670 M ³ H Lighting n° 2 spots Energy Class A  H. MIN. 53 CM  NO TUBO CAPPA NO HOOD TUBE	INOX STAINLESS	
		60	-
		90	-
		120	-
OPTIONAL OPTIONAL 	Maggiorazione MOTORE "SLIVER" (Anticondensa) Portata Motore 620 M ³ H Illuminazione Lampada fluorescente Classe Energetica A Surcharge "SLIVER" MOTOR (Anticondensation) Engine capacity 620 M ³ H Lighting fluorescent lamp Energy Class A  H. MIN. 45 CM  NO TUBO CAPPA NO HOOD TUBE	INOX STAINLESS	
		60	-
		NEW 75	-
		90	-
		120	-
		ANTRACITE ANTHRACITE	
		NEW 60	-
		75	-
90	-		
120	-		

E1	E2	E4
+ 365	+ 365	+ 365
+ 395	+ 395	+ 395
+ 435	+ 435	+ 435
+ 715	+ 715	+ 715
+ 962	+ 962	+ 962
+ 745	+ 745	+ 745
+ 875	+ 875	+ 875
+ 865	+ 865	+ 865
+ 1069	+ 1069	+ 1069
+ 975	+ 975	+ 975
+ 1115	+ 1115	+ 1115

PENSILI

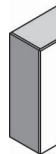
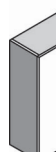
WALL UNITS

h.96 / p.34



STRUTTURA STRUCTURE	DESCRIZIONE DESCRIPTION	LARGH. (cm) WIDTH (cm)	CODICE CODE
	FASCIA TAMPONAMENTO FILLER	3/15	PA00J00
	PENSILE ESTRAIBILE PULL-OUT WALL UNIT	15	PD15J00
	PENSILE 1 ANTA 2 ripiani WALL UNIT 1 DOOR, 2 shelves	15	PR15J00
		30	PR30J00
		40	PR40J00
		45	PR45J00
		60	PR60J00
		NEW NEW	65
	75	PR75J00	
	PENSILE 2 ANTE, 2 ripiani WALL UNIT 2 DOORS, 2 shelves	60	PR60J02
		90	PR90J00
	PENSILE 1 ANTA, 2 ripiani "Sali/Scendi" colore antracite WALL UNIT 1 DOOR, 2 shelves "Up / Down" anthracite color	60	PR60J04
	PENSILE ANGOLO 90°, 2 ripiani Anta H. 95,7 x L. 28 cm + Anta H. 95,7 x L. 29,7 cm (65 x 65) 90° CORNER WALL UNIT, 2 shelves Door H 95,7 x W 28 cm + Door H 95,7 x W 29,7 cm (65 x 65)	65x65	PH65J00
	PENSILE ANGOLO CON TAPPO, 1 ripiano Anta H. 95,7 x L. 27,65 cm CORNER WALL UNIT WITH CAP, 1 shelf Door H 95,7 x W 27,65 cm	65x37	PT65J00
	PENSILE 1 ANTA IN ACCOSTO AL PENSILE ANGOLO CON TAPPO, 1 ripiano Anta H. 95,7 x L. 27,65 cm WALL UNIT 1 DOOR ADJACENT FORCORNER WALL UNIT WITH CAP, 1 shelf Door H 95,7 x W 27,65 cm	28	PR28J00

E1	E2	E4
115	117	123
164	168	181
123	128	140
137	142	167
146	155	181
160	167	193
161	176	205
199	209	262
210	221	284
200	210	261
238	252	303
856	871	900
348	357	409
348	354	386
137	141	166

PENSILI

WALL UNITS

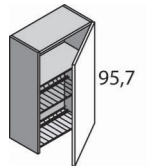
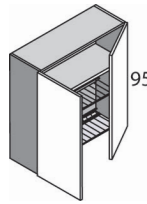
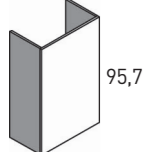
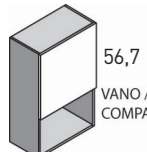
h.96 /p.34

STRUTTURA STRUCTURE	DESCRIZIONE DESCRIPTION	LARGH. (cm) WIDTH (cm)	CODICE CODE	
 95,7	COLAPIATTI 1 ANTA, 1 ripiano 1 griglia portapiatti, 1 griglia portabicchieri DISH DRAINER UNIT 1 DOOR, 1 shelf, 1 plate-rack, 1 glass-rack	45	SR45J00	
		60	SR60J00	
		75	SR75J00	
		Maggiorazione vaschetta inox raccogli gocce Surcharge steel drip tray	45 60	- -
 95,7	COLAPIATTI 2 ANTE, 1 ripiano 1 griglia portapiatti 1 griglia portabicchieri DISH DRAINER UNIT 2 DOORS, 1 shelf 1 plate-rack, 1 glass-rack	80	SR80J00	
		90	SR90J00	
			Maggiorazione vaschetta inox raccogli gocce Surcharge steel drip tray	80 90
	 95,7	COPRIBOILER 1 ANTA BOILER HOUSING 1 DOOR	Prof.34 Depth 34	PR60J01
Prof.45 Depth 45			PR60J03	
 56,7 VANO / H.36,2 COMPARTMENT	PENSILE 1 ANTA E VANO PER MICROONDE, 1 ripiano WALL UNIT 1 DOOR AND COMPARTMENT FOR MICROWAVE, 1 shelf	60	PW60J01	
 59,7 VANO / H.36,2 COMPARTMENT	PENSILE 1 ANTA E VANO PER MICROONDE WHIRLPOOL, 1 ripiano WALL UNIT 1 DOOR AND COMPARTMENT FOR MICROWAVE WHIRLPOOL, 1 shelf	60	PW60J00	

E1	E2	E4
210	218	243
227	242	271
280	290	353
+ 20	+ 20	+ 20
+ 20	+ 20	+ 20
292	309	362
318	332	383
+ 26	+ 26	+ 26
+ 26	+ 26	+ 26
138	153	182
144	159	188
194	201	229
196	204	222



Possibilità di inserire a richiesta con maggiorazione il colapiatti DELUXE (vedi articolo alla sezione MAGGIORAZIONI)
Possibility of inserting the DELUXE dish drainer on request with surcharge (see article in the section SURCHARGES)









Considerare maggiorazione per ante con apertura Premi/Apri per elemento abbinato a moduli con gola + 25 PTS.
Consider surcharge for doors with Push/Pull opening for element combined to modules with groove + 25 PTS.

PENSILI CAPPA

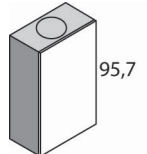
HOOD WALL UNITS

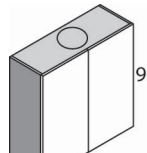
h.96 / p.34

IL PRIMO PREZZO È QUELLO DEL PENSILE CAPPA CON MOTORE "MAGIC" (DI SERIE).
PER OTTENERE IL PREZZO DEL PENSILE CAPPA CON UN ALTRO MOTORE DIVERSO DAL MAGIC,
UNO TRA QUELLI DISPONIBILI (OPTIONAL), OCCORRE SOMMARE I PREZZI DI MAGGIORAZIONE.
THE FIRST PRICE IS THAT OF THE HOOD RACK WITH "MAGIC" MOTOR (STANDARD).
TO OBTAIN THE PRICE OF THE HOOD ROOF WITH ANOTHER ENGINE DIFFERENT FROM THE MAGIC,
ONE OF THOSE AVAILABLE (OPTIONAL), IT IS NECESSARY TO SUMMARIZE THE PRICE OF INCREASE.

STRUTTURA STRUCTURE	DESCRIZIONE DESCRIPTION	LARGH. (cm) WIDTH (cm)	CODICE CODE
 95,7 DI SERIE STANDARD 	PENSILE CAPPA 1 ANTA, motore "MAGIC" Portata Motore 500 M ³ H Illuminazione n° 2 Faretti Per Largh. 60 cm : Classe Energetica C Per Largh. 75 cm : Classe Energetica A HOOD UNIT 1 DOOR, "MAGIC" motor Engine capacity 500 M ³ H Lighting n° 2 spots For Width 60 cm : Energy Class C For Width 75 cm : Energy Class A	INOX STAINLESS	60 DZ60J00
		NEW	75 DZ75J00
 95,7 DI SERIE STANDARD 	PENSILE CAPPA 2 ANTE, MOTORE "MAGIC" Portata Motore 500 M ³ H Illuminazione n° 2 Faretti Classe Energetica C HOOD UNIT 2 DOORS, "MAGIC" MOTOR Engine capacity 500 M ³ H Lighting n° 2 spots Energy Class C	INOX STAINLESS	90 DZ90J00
			120 DZ12J00
OPTIONAL OPTIONAL 	Maggiorazione MOTORE "OPTIMA" Portata Motore 710 M ³ H Illuminazione n° 2 Faretti Classe Energetica A Surcharge "OPTIMA" MOTOR Engine capacity 710 M ³ H Lighting n° 2 spots Energy Class A	INOX STAINLESS	60 90 120 -
		ANTRACITE ANTHRACITE	60 90 120 -
OPTIONAL OPTIONAL 	Maggiorazione MOTORE "VIRGOLA NO-DROP" (Anticondensa) Portata Motore 600 M ³ H Illuminazione n° 2 Faretti Classe Energetica C Surcharge "VIRGOLA NO-DROP" MOTOR (Anticondensation) Engine capacity 600 M ³ H Lighting n° 2 spots Energy Class C	INOX STAINLESS	60 90 120 -
OPTIONAL OPTIONAL 	Maggiorazione MOTORE "FUSION ADVANCED" (Anticondensa) Portata Motore 818 M ³ H Illuminazione Lampada fluorescente Classe Energetica A Surcharge "FUSION ADVANCED" MOTOR (Anticondensation) Engine capacity 818 M ³ H Lighting fluorescent lamp Energy Class A	INOX STAINLESS	60 90 120 -
		ANTRACITE ANTHRACITE	60 90 120 -

E1	E2	E4
537	552	581
656	666	729
624	639	689
720	749	808
+ 90	+ 90	+ 90
+ 90	+ 90	+ 90
+ 90	+ 90	+ 90
+ 135	+ 135	+ 135
+ 135	+ 135	+ 135
+ 135	+ 135	+ 135
+ 695	+ 695	+ 695
+ 735	+ 735	+ 735
+ 865	+ 865	+ 865
+ 1160	+ 1160	+ 1160
+ 1265	+ 1265	+ 1265
+ 1495	+ 1495	+ 1495
+ 1160	+ 1160	+ 1160
+ 1265	+ 1265	+ 1265
+ 1495	+ 1495	+ 1495

PENSILI CAPPA

HOOD WALL UNITS

h.96 /p.34

IL PRIMO PREZZO È QUELLO DEL PENSILE CAPPA CON MOTORE "MAGIC" (DI SERIE).
 PER OTTENERE IL PREZZO DEL PENSILE CAPPA CON UN ALTRO MOTORE DIVERSO DAL MAGIC,
 UNO TRA QUELLI DISPONIBILI (OPTIONAL), OCCORRE SOMMARE I PREZZI DI MAGGIORAZIONE.
 THE FIRST PRICE IS THAT OF THE HOOD RACK WITH "MAGIC" MOTOR (STANDARD).
 TO OBTAIN THE PRICE OF THE HOOD ROOF WITH ANOTHER ENGINE DIFFERENT FROM THE MAGIC,
 ONE OF THOSE AVAILABLE (OPTIONAL), IT IS NECESSARY TO SUMMARIZE THE PRICE OF INCREASE.

STRUTTURA STRUCTURE	DESCRIZIONE DESCRIPTION	LARGH. (cm) WIDTH (cm)	CODICE CODE
OPTIONAL OPTIONAL 	Maggiorazione MOTORE "ILMA" (Anticondensa) Portata Motore 455 M ³ H Illuminazione n° 2 Faretti Classe Energetica A Surcharge "ILMA" MOTOR (Anticondensation) Engine capacity 455 M ³ H Lighting n° 2 spots Energy Class A	INOX STAINLESS	
		60	-
		90	-
		120	-
OPTIONAL OPTIONAL 	Maggiorazione MOTORE "IN-NOVA" Portata Motore 670 M ³ H Illuminazione n° 2 Faretti Classe Energetica A Surcharge "IN-NOVA" MOTOR Engine capacity 670 M ³ H Lighting n° 2 spots Energy Class A	INOX STAINLESS	
		60	-
		90	-
		120	-
OPTIONAL OPTIONAL  	Maggiorazione MOTORE "SLIVER" (Anticondensa) Portata Motore 620 M ³ H Illuminazione Lampada fluorescente Classe Energetica A Surcharge "SLIVER" MOTOR (Anticondensation) Engine capacity 620 M ³ H Lighting fluorescent lamp Energy Class A	INOX STAINLESS	
		60	-
		NEW 75	-
		90	-
		120	-
		ANTRACITE ANTHRACITE	
		60	-
		NEW 75	-
		90	-
		120	-
 H. MIN. 45 CM H. MIN. 45 CM		 NO TUBO CAPPA NO HOOD TUBE	

E1	E2	E4
+ 1090	+ 1090	+ 1090
+ 1140	+ 1140	+ 1140
+ 1270	+ 1270	+ 1270
+ 365	+ 365	+ 365
+ 395	+ 395	+ 395
+ 435	+ 435	+ 435
+ 715	+ 715	+ 715
+ 962	+ 962	+ 962
+ 745	+ 745	+ 745
+ 875	+ 875	+ 875
+ 865	+ 865	+ 865
+ 1069	+ 1069	+ 1069
+ 975	+ 975	+ 975
+ 1115	+ 1115	+ 1115

PENSILI

WALL UNITS

h.108 /p.34

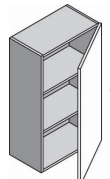
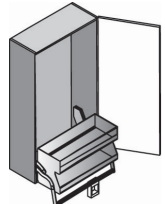
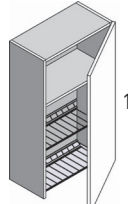
STRUTTURA STRUCTURE	DESCRIZIONE DESCRIPTION	LARGH. (cm) WIDTH (cm)	CODICE CODE
	FASCIA TAMPONAMENTO FILLER	3/15	PA00L00
 107,7	PENSILE 1 ANTA 2 ripiani WALL UNIT 1 DOOR, 2 shelves	45	PR45L00
		60	PR60L00
 107,7	PENSILE 1 ANTA, 2 ripiani "Salì/Scendi" WALL UNIT 1 DOOR, 2 shelves "Up / Down"	60	PR60L02
 107,7	COLAPIATTI 1 ANTA, 1 ripiano 1 griglia portapiatti, 1 griglia portabicchieri DISH DRAINER UNIT 1 DOOR, 1 shelf, 1 plate-rack, 1 glass-rack	45	SR45L00
		60	SR60L00
	Maggiorazione vaschetta inox raccogliocce Surcharge steel drip tray	45	-
		60	-



E1	E2	E4
119	121	128
182	197	226
201	215	264
875	889	938
238	252	282
257	270	320
+ 20	+ 20	+ 20
+ 20	+ 20	+ 20

PENSILI

WALL UNITS

h.132 /p.34

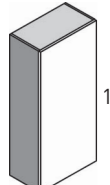
STRUTTURA STRUCTURE	DESCRIZIONE DESCRIPTION	LARGH. (cm) WIDTH (cm)	CODICE CODE
	FASCIA TAMPONAMENTO FILLER	3/15	PA00N00
 131,7	PENSILE 1 ANTA, 3 ripiani WALL UNIT 1 DOOR, 3 shelves	45	PR45N00
		60	PR60N00

E1	E2	E4
125	128	134
189	209	245
217	242	285



Possibilità di inserire a richiesta con maggiorazione il colapiatti DELUXE (vedi articolo alla sezione MAGGIORAZIONI)
Possibility of inserting the DELUXE dish drainer on request with surcharge (see article in the section SURCHARGES)

SOPRA COLONNE

ABOVE TALL UNITS

h.36 /p.59

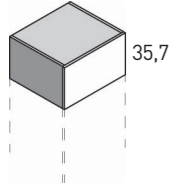
STRUTTURA STRUCTURE	DESCRIZIONE DESCRIPTION	LARGH. (cm) WIDTH (cm)	CODICE CODE
 35,7	SOPRA COLONNA 1 ANTA OVEN TALL UNIT 1 DOOR	45	CD45B02
		60	CD60B02
 35,7	SOPRA COLONNA VASISTAS OVEN TALL UNIT WALL UNIT W/LIFT-UP DOOR	75	CD75B00
			

SOPRA COLONNE

ABOVE TALL UNITS

h.48 /p.59

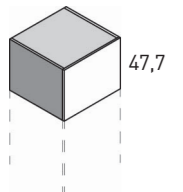
STRUTTURA STRUCTURE	DESCRIZIONE DESCRIPTION	LARGH. (cm) WIDTH (cm)	CODICE CODE
 47,7	SOPRA COLONNA 1 ANTA OVEN TALL UNIT 1 DOOR	45	CD45B03
		60	CD60B03
 47,7	SOPRA COLONNA VASISTAS OVEN TALL UNIT WALL UNIT W/LIFT-UP DOOR	75	CD75D00
			

E1	E2	E4
98	102	114
110	115	130

199	206	228
-----	-----	-----

E1	E2	E4
119	123	140
136	140	157

212	221	243
-----	-----	-----



Mobile in appoggio senza attaccaglie
Mobile in support without hangers

COLONNE PER ELETTRODOMESTICI

APPLIANCES TALL UNITS

h.138-141 (MANGIA LINEAR - MANIGLIA GRIP)
(LINEAR HANDLE - GRIP HANDLE) /p.59

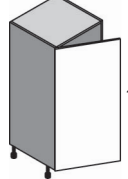
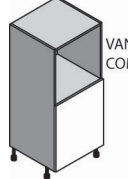
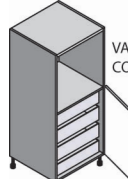
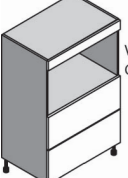
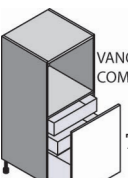
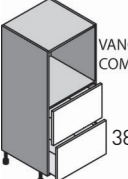
STRUTTURA STRUCTURE	DESCRIZIONE DESCRIPTION	LARGH. (cm) WIDTH (cm)	CODICE CODE
 137,7	COLONNA FRIGO 1 ANTA 225 LT. TALL FRIDGE UNIT 1 DOOR 225 L.	60	CQ60N00
 VANO / 58,1 COMPARTMENT	COLONNA FORNO 1 ANTA, 2 ripiani TALL OVEN UNIT 1 DOOR, 2 shelves	60 NEW 75	CH60N00 CH75N00
 VANO / 58,1 COMPARTMENT	COLONNA FORNO 1 ANTA, 4 Cassetti interni TALL OVEN UNIT 1 DOOR, 4 drawers	60	CH60N07
	Trascinatore per cassetto interno Dragger for inner drawer	cad. 1	GFN0060
 11,7 VANO / 47,5 COMPARTMENT	COLONNA FORNO RIBASSATO 2 CESTI LOWERED TALL OVEN UNIT 2 DEEP-PAN DRAWERS	90	CH90N06
 VANO / 58,1 COMPARTMENT	COLONNA FORNO 1 CESTONE, 2 Cassetti interni TALL OVEN UNIT 1 DEEP-PAN DRAWER, 2 drawers	60	CH60N02
	Trascinatore per cassetto interno Dragger for inner drawer	cad. 1	GFN0060
 VANO / 58,1 COMPARTMENT	COLONNA FORNO 2 CESTI TALL OVEN UNIT 2 DEEP-PAN DRAWERS	60 90 NEW 75	CH60N01 CH90N02 CH75N01

E1	E2	E4
235	259	327
213	234	265
277	291	348
499	510	552
+ 15	+ 15	+ 15
487	506	583
464	474	500
+ 15	+ 15	+ 15
357	366	404
430	443	497
427	439	483

COLONNE





Per strutture con gola è consigliato l'inserimento della gola verticale in entrambi i lati per una corretta apertura
For structures with groove, the introduction of the vertical groove is recommended on both sides for correct opening

COLONNE ATTREZZATE

FITTED TALL UNITS

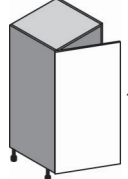
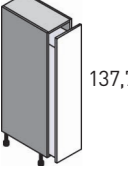
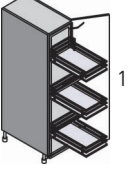
h.138-141 (MANGILA LINEAR - MANIGLIA GRIP)
(LINEAR HANDLE - GRIP HANDLE) /p.59

STRUTTURA STRUCTURE	DESCRIZIONE DESCRIPTION	LARGH. (cm) WIDTH (cm)	CODICE CODE
	FASCIA TAMPONAMENTO FILLER	3/10	CB00N00
	COLONNA DISPENSA 1 ANTA, 2 ripiani TALL LARDER UNIT 1 DOOR, 2 shelves	30 45 60	CD30N02 CD45N00 CD60N00
	COLONNA ESTRAIBILE, erramenta colore Stone o Titanio PULL-OUT TALL UNIT, colors hardware Stone orTitanio	30	CD30N00
	COLONNA ATTREZZATA TOTAL VIEW APERT. 180°, cesti interni estraibili ferramenta colore Stone o Titanio 180° OPENING EQUIPPED TOTAL VIEW TALL UNIT, pull-out inner deep-pan drawers colors hardware Stone orTitanio	30	CD30N03
	COLONNA ATTREZZATA TOTAL VIEW APERT.180° 1 ANTA UNICA, cesti interni estraibili ferramenta colore Stone o Titanio COMPOSTA DA: - elemento a giorno "L10" terminale latereale A - colonna attrezzata total view apert. 180° B 180° OPENING EQUIPPED TOTAL VIEW TALL UNIT 1 DOOR, pull-out inner deep-pan drawers colors hardware Stone orTitanio - "L10" open element side open end A - 180° opening equipped total view tall unit 1 door B		
	ELEMENTO A GIORNO "L10" VERSIONE LACCATO OPACO "L10" OPEN ELEMENT VERSION MATT LACQUERED	A 30 B 30	TL59000 CD30N04 Totale A+B
	ELEMENTO A GIORNO "L10" VERSIONE TERMO STRUTTURATO - LAMINATO MATERICO - NOBILITATO "L10" OPEN ELEMENT VERSION THERMO TEXTURED - TEXTURED LAMINATE - MELAMINE	A 30 B 30	TL59000 CD30N04 Totale A+B



14 Per strutture con gola è consigliato l'inserimento della gola verticale in entrambi i lati per una corretta apertura
For structures with groove, the introduction of the vertical groove is recommended on both sides for correct opening

15 Per colorazioni disponibili per ELEMENTI A GIORNO "L10" vedi sezione dedicata
For colors available for "L10" OPEN ELEMENTS see the dedicated section

16 Considerare spazio libero laterale di 60 cm per una apertura completa
Consider a lateral free space of 60 cm for a complete opening

17 Considerare spazio libero laterale di 30 cm per una apertura completa
Consider a lateral free space of 30 cm for a complete opening

E1	E2	E4
129	131	137
204	214	248
219	248	291
244	284	342
556	565	605
638	647	687
949	949	949
647	671	745
1596	1620	1694
621	621	621
647	671	725
1268	1292	1366

COLONNE ATTREZZATE

FITTED TALL UNITS

h.138-141 (MANIGLIA LINEAR - MANIGLIA GRIP)
(LINEAR HANDLE - GRIP HANDLE) /p.59

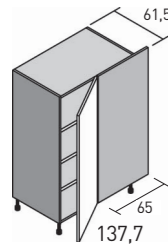
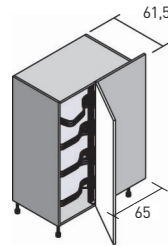
STRUTTURA STRUCTURE	DESCRIZIONE DESCRIPTION	LARGH. (cm) WIDTH (cm)	CODICE CODE
	COLONNA ANGOLO 1 ANTA, 3 ripiani (con tappo) CORNER TALL UNIT 1 DOOR, 3 shelves (with cap)	scocca 105 <small>carcass 105</small> 110xX61,5	CA11N00
		scocca 120 <small>carcass 120</small> 125x61,5	CA1AN00
	COLONNA ANGOLO 1 ANTA, 4 cesti Freedom ferramenta colore Stone o Titanio (con tappo) CORNER TALL UNIT 1 DOOR, 4 Freedom deep-pan drawers colors hardware Stone orTitanio (with cap)	scocca 105 <small>carcass 105</small> 110xX61,5	CA11N01
		scocca 120 <small>carcass 120</small> 125x61,5	CA1AN01



MAGGIORAZIONE TAPPO A VISTA

SURCHARGE FOR VISIBLE CAP

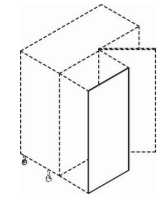
STRUTTURA STRUCTURE	DESCRIZIONE DESCRIPTION
	MAGGIORAZIONE TAPPO A VISTA, spessore come anta (DA SOMMARE AL COSTO DELLA COLONNA ANGOLO) H. 137,7 x L. 65 cm SURCHARGE FOR VISIBLE CAP, thickness as a door (TO BE ADDED TO THE COST OF THE TALL CORNER UNIT) H. 137,7 x W. 65 cm



E1	E2	E4
342	361	414
388	412	486

1309	1328	1381
1470	1495	1568

TERMO STRUTTURATO THERMO TEXTURED	PET PET	LAMINATO MATERICO TEXTURED LAMINATE	FENIX FENIX
+ 90	+ 67	+ 75	+ 155



Per ante in vetro Aliant il tappo è previsto solamente laccato nei colori ante
For Aliant glass doors the cap is provided only lacquered in the door colors

COLONNE SOSPESSE PER ELETTRODOMESTICI

APPLIANCES SUSPENDED TALL UNITS

h.129 (MANIGLIA LINEAR - MANIGLIA GRIP)
(LINEAR HANDLE - GRIP HANDLE) - 132/p.59

STRUTTURA STRUCTURE	DESCRIZIONE DESCRIPTION	LARGH. (cm) WIDTH (cm)	CODICE CODE
 <p>68,7 - 71,7 VANO / 58,7 COMPARTMENT LVS</p>	COLONNA FORNO 1 ANTA, 1 ripiano (posizionata sopra lavastoviglie) TALL OVEN UNIT 1 DOOR, 1 shelf (positioned above dishwasher)	60	CH60M00
		NEW 75	CH75M00

COLONNE SOSPESSE ATTREZZATE

FITTED SUSPENDED TALL UNITS

h.129 (MANIGLIA LINEAR - MANIGLIA GRIP)
(LINEAR HANDLE - GRIP HANDLE) 132/p.59

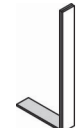
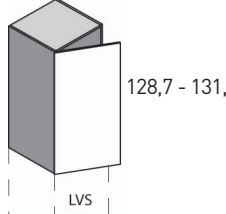
STRUTTURA STRUCTURE	DESCRIZIONE DESCRIPTION	LARGH. (cm) WIDTH (cm)	CODICE CODE
	FASCIA TAMPONAMENTO FILLER	3/10	CB00M00
 <p>128,7 - 131,7 LVS</p>	COLONNA DISPENSA 1 ANTA, 2 ripiani (posizionata sopra lavastoviglie) TALL LARDER UNIT 1 DOOR, 2 shelves (positioned above dishwasher)	45	CD45M00
		60	CD60M00
		NEW 75	CD75M00

E1

E2

E4

225

236

259

266

282

315

E1

E2

E4

123

125

132

228

248

284

257

282

325

327

329

405

COLONNE SOSPESSE PER ELETTRODOMESTICI

APPLIANCES SUSPENDED TALL UNITS

h.153 (MANGILA LINEAR - MANIGLIA GRIP)
(LINEAR HANDLE - GRIP HANDLE) - 156 / p.59

STRUTTURA STRUCTURE	DESCRIZIONE DESCRIPTION	LARGH. (cm) WIDTH (cm)	CODICE CODE
	COLONNA FORNO 1 ANTA, 2 ripiani (posizionata sopra lavastoviglie) TALL OVEN UNIT 1 DOOR, 2 shelves (positioned above dishwasher)	60	CH60Q00
		NEW 75	CH75Q00

E1	E2	E4
264	279	308
307	318	381

COLONNE SOSPESSE ATTREZZATE

FITTED SUSPENDED TALL UNITS

h.153 (MANGILA LINEAR - MANIGLIA GRIP)
(LINEAR HANDLE - GRIP HANDLE) - 156 / p.59

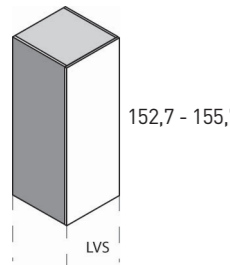
STRUTTURA STRUCTURE	DESCRIZIONE DESCRIPTION	LARGH. (cm) WIDTH (cm)	CODICE CODE
	FASCIA TAMPONAMENTO FILLER	3/10	CB00Q00
COLONNA DISPENSA 1 ANTA, 3 ripiani (posizionata sopra lavastoviglie) TALL LARDER UNIT 1 DOOR, 3 shelves (positioned above dishwasher)	NEW	45	CD45Q00
		60	CD60Q00
		75	CD75Q00

E1	E2	E4
145	149	155
285	307	321
298	320	360
341	368	473

COLONNE PER FRIGO

FRIDGE TALL UNITS

h.210 /p.59

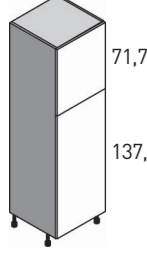
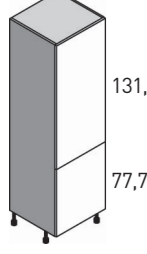
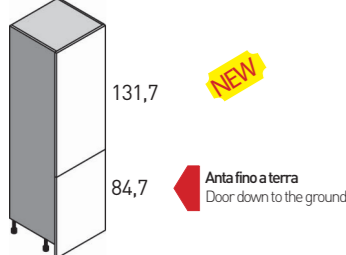
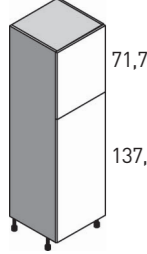
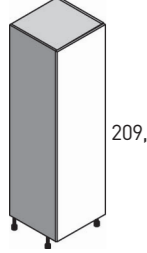
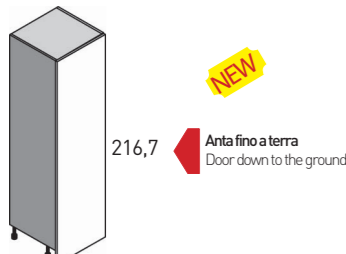
STRUTTURA STRUCTURE	DESCRIZIONE DESCRIPTION	LARGH. (cm) WIDTH (cm)	CODICE CODE
	COLONNA FRIGO 230/260 LT. TALL FRIDGE UNIT 230/260 L.	60	CQ60P00
	COLONNA FRIGO 270/330 LT. TALL FRIDGE UNIT 270/330 L.	60	CQ60P02
	COLONNA FRIGO 270/330 LT. TALL FRIDGE UNIT 270/330 L.	60	CQ60P11
	COLONNA FRIGO 220 LT., sopra dispensa 1 ripiano TALL FRIDGE UNIT 220 L., over larder 1 shelf	60	CQ60P06
	COLONNA FRIGO 270/330 LT., anta unica TALL FRIDGE UNIT 270/330 L., single door	60	CQ60P10
	COLONNA FRIGO 270/330 LT., anta unica TALL FRIDGE UNIT 270/330 L., single door	60	CQ60P12

E1	E2	E4
361	395	476
345	381	466
403	432	518
380	414	495
288	323	440
370	391	514



Aggiungere sempre un fianco di riporto fino a terra nel caso in cui la struttura è terminale con lato a vista
Always add a side facing down to the ground in the event that the structure is terminal with a visible side



Struttura disponibile solo con Zoccolo H. 8 cm
Structure available only with Plinth H. 8 cm

COLONNE PER FRIGO

FRIDGE TALL UNITS

h.210 /p.59

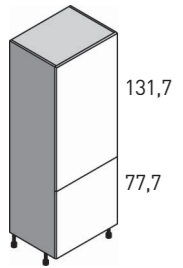
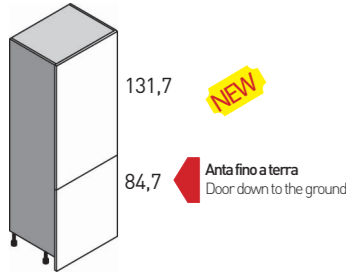
STRUTTURA STRUCTURE	DESCRIZIONE DESCRIPTION	LARGH. (cm) WIDTH (cm)	CODICE CODE
	COLONNA FRIGO 400 LT. TALL FRIDGE UNIT 400 L.	75	CQ75P00
	COLONNA FRIGO 400 LT. TALL FRIDGE UNIT 400 L.	75	CQ75P01

E1	E2	E4
444	460	577
501	514	644

COLONNE PER FORNO

OVEN TALL UNITS

h.210 /p.59

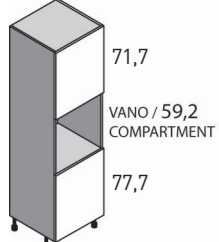
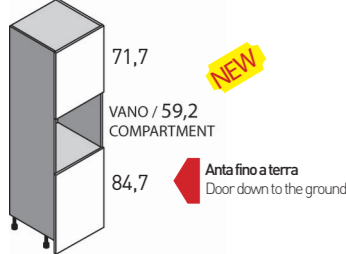
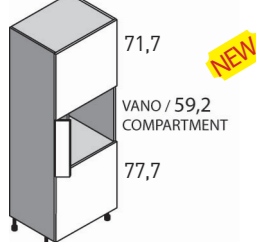
STRUTTURA STRUCTURE	DESCRIZIONE DESCRIPTION	LARGH. (cm) WIDTH (cm)	CODICE CODE
	COLONNA FORNO 1 ANTA, 2 ripiani TALL OVEN UNIT 1 DOOR, 2 shelves	60 75	CH60P00 CH75P00
	COLONNA FORNO 1 ANTA, 2 ripiani TALL OVEN UNIT 1 DOOR, 2 shelves	60 75	CH60P12 CH75P01
	COLONNA FORNO 1 ANTA, 2 ripiani VANO DA 15 CON ANTA apertura Premi/Apri TALL OVEN UNIT 1 DOOR, 2 shelves COMPARTMENT OF 15 WITH DOOR Push/Pull opening	75	CH75P02

E1	E2	E4
357 424	378 454	444 544
418 474	432 502	499 590
521	554	650







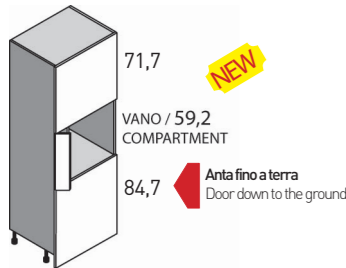

 Aggiungere sempre un fianco di riporto fino a terra nel caso in cui la struttura è terminale con lato a vista
Always add a side facing down to the ground in the event that the structure is terminal with a visible side

 Struttura disponibile solo con Zoccolo H. 8 cm
Structure available only with Plinth H. 8 cm

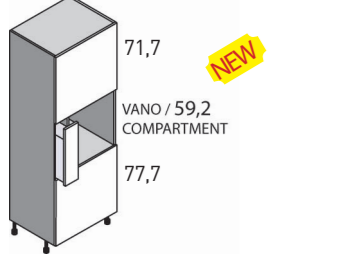
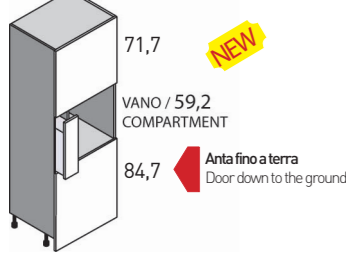
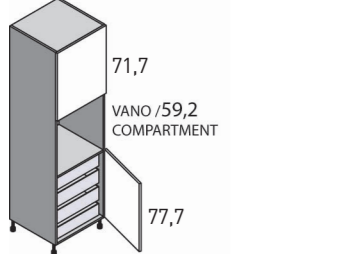
COLONNE PER FORNO

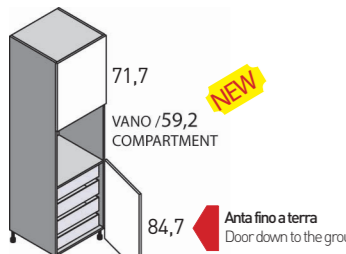
OVEN TALL UNITS

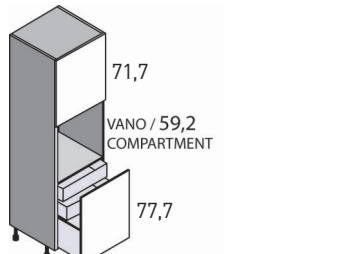
h.210 /p.59

STRUTTURA STRUCTURE	DESCRIZIONE DESCRIPTION	LARGH. (cm) WIDTH (cm)	CODICE CODE
 <p>71,7 NEW VANO / 59,2 COMPARTMENT 84,7 Anta fino a terra Door down to the ground</p>	COLONNA FORNO 1 ANTA, 2 ripiani VANO DA 15 CON ANTA apertura Premi/Apri TALL OVEN UNIT 1 DOOR, 2 shelves COMPARTMENT OF 15 WITH DOOR Push/Pull opening	75	CH75P03
			
 <p>71,7 NEW VANO / 59,2 COMPARTMENT 77,7</p>	COLONNA FORNO 1 ANTA, 2 ripiani VANO DA 15 CON ANTA ESTRAIBILE PORTATEGLIE apertura Premi/Apri TALL OVEN UNIT 1 DOOR, 2 shelves COMPARTMENT OF 15 WITH PULL-OUT DOOR TRAY HOLDER Push/Pull opening	75	CH75P04
 <p>71,7 NEW VANO / 59,2 COMPARTMENT 84,7 Anta fino a terra Door down to the ground</p>	COLONNA FORNO 1 ANTA, 2 ripiani VANO DA 15 CON ANTA ESTRAIBILE PORTATEGLIE apertura Premi/Apri TALL OVEN UNIT 1 DOOR, 2 shelves COMPARTMENT OF 15 WITH PULL-OUT DOOR TRAY HOLDER Push/Pull opening	75	CH75P05
 <p>71,7 VANO / 59,2 COMPARTMENT 77,7</p>	COLONNA FORNO 1 ANTA APERT. 180°, 1 ripiano e 4 cassetti interni TALL OVEN UNIT 1 DOOR 180° OPENING, 1 shelf and 4 drawers	60	CH60P08
		NEW 75 Trascinatore per cassetto interno Dragger for inner drawer cad. 1	CH75P06
 <p>71,7 NEW VANO / 59,2 COMPARTMENT 84,7 Anta fino a terra Door down to the ground</p>	COLONNA FORNO 1 ANTA APERT. 180°, 1 ripiano e 4 cassetti interni TALL OVEN UNIT 1 DOOR 180° OPENING, 1 shelf and 4 drawers	60	CH60P13
		Trascinatore per cassetto interno Dragger for inner drawer cad. 1	GFN0060
 <p>71,7 VANO / 59,2 COMPARTMENT 77,7</p>	COLONNA FORNO 1 CESTONE, 1 ripiano e 2 cassetti interni TALL OVEN UNIT 1 DEEP-PAN DRAWER, 1 shelf and 2 drawers	60	CH60P05
		Trascinatore per cassetto interno Dragger for inner drawer cad. 1	GFN0060

E1	E2	E4
572	601	696
709	742	838
760	789	884
649	670	720
785	815	906
+ 15	+ 15	+ 15
689	713	769
+ 15	+ 15	+ 15
593	614	668
+ 15	+ 15	+ 15

 Per strutture con gola è consigliato l'inserimento della gola verticale in entrambi i lati per una corretta apertura
 For structures with groove, the introduction of the vertical groove is recommended on both sides for correct opening

 Possibilità di avere il vano con Anta apribile posizionato a DX o SX del vano del Forno
 Possibility of having the compartment with opening door positioned to the right or left of the oven compartment

 Aggiungere sempre un fianco di riparto fino a terra nel caso in cui la struttura è terminale con lato a vista
 Always add a side facing down to the ground in the event that the structure is terminal with a visible side

 Struttura disponibile solo con Zoccolo H. 8 cm
 Structure available only with Plinth H. 8 cm

COLONNE PER FORNO

OVEN TALL UNITS

h.210 /p.59

STRUTTURA STRUCTURE	DESCRIZIONE DESCRIPTION	LARGH. (cm) WIDTH (cm)	CODICE CODE
	COLONNA FORNO 2 CESTI, 1 ripiano TALL OVEN UNIT 2 DEEP-PAN DRAWERS, 1 shelf 	60 75	CH60P03 CH75P07
	COLONNA FORNO 1 ANTA + 1 ANTA VELA, 1 ANTA INFERIORE, 2 ripiani TALL OVEN UNIT 1 DOOR + 1 DOOR SLIDE, 1 LOWER DOOR, 2 shelves	60	CH60P09
	COLONNA FORNO 1 ANTA + 1 ANTA VELA, 1 CESTO INFERIORE TALL OVEN UNIT 1 DOOR + 1 DOOR SLIDE, 1 LOWER DEEP-PAN DRAWER 	60	CH60P10
	COLONNA FORNO + MICROONDE 1 ANTA, 1 ripiano OVEN + MICROWAVE OVEN TALL UNIT 1 DOOR 1 shelf	60	CM60P18
 Anta fino a terra Door down to the ground	COLONNA FORNO + MICROONDE 1 ANTA, 1 ripiano OVEN + MICROWAVE OVEN TALL UNIT 1 DOOR 1 shelf	60	CM60P24
	COLONNA FORNO + MICROONDE 1 CESTO, 1 cassetto interno OVEN + MICROWAVE OVEN TALL UNIT 1 DEEP-PAN DRAWER, 1 inner drawer 	60 cad. 1	CM60P19 GFN0060 <small>Trascinatore per cassetto interno Dragger for inner drawer</small>



Per strutture con gola è consigliato l'inserimento della gola verticale in entrambi i lati per una corretta apertura
 For structures with groove, the introduction of the vertical groove is recommended on both sides for correct opening



Aggiungere sempre un fianco di riporto fino a terra nel caso in cui la struttura è terminale con lato a vista
 Always add a side facing down to the ground in the event that the structure is terminal with a visible side



Struttura disponibile solo con Zoccolo H. 8 cm
 Structure available only with Plinth H. 8 cm

E1	E2	E4
497	516	577
574	602	680
541	561	633
634	654	725
317	328	380
366	381	421
481	493	544
+ 15	+ 15	+ 15

COLONNE PER FORNO

OVEN TALL UNITS

h.210 /p.59

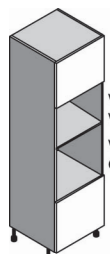
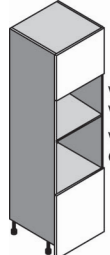
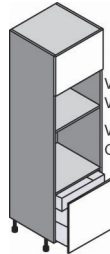
STRUTTURA STRUCTURE	DESCRIZIONE DESCRIPTION	LARGH. (cm) WIDTH (cm)	CODICE CODE
 <p>44,7 VANO VARIABILE / da H.34 a H.44,9 VARIABLE COMPARTMENT VANO / 59,2 COMPARTMENT 58,2</p>	<p>COLONNA FORNO + MICROONDE 1 ANTA, 1 ripiano OVEN + MICROWAVE OVEN TALL UNIT 1 DOOR 1 shelf</p> <p>con massello with solid wood</p>	60	CM60P20
 <p>44,7 NEW VANO VARIABILE / da H.34 a H.44,9 VARIABLE COMPARTMENT VANO / 59,2 COMPARTMENT 65,2 Anta fino a terra Door down to the ground</p>	<p>COLONNA FORNO + MICROONDE 1 ANTA, 1 ripiano OVEN + MICROWAVE OVEN TALL UNIT 1 DOOR 1 shelf</p>	60	CM60P25
 <p>44,7 VANO VARIABILE / da H.34 a H.44,9 VARIABLE COMPARTMENT VANO / 59,2 COMPARTMENT 58,2</p>	<p>COLONNA FORNO + MICROONDE 1 CESTO, 1 cassetto interno OVEN + MICROWAVE OVEN TALL UNIT 1 DEEP-PAN DRAWER, 1 inner drawer</p> <p>con massello with solid wood</p> <p>Trascinatore per cassetto interno Dragger for inner drawer</p>	60 cad. 1	CM60P21 GFN0060

COLONNE ATTREZZATE

FITTED TALL UNITS

h.210 /p.59

STRUTTURA STRUCTURE	DESCRIZIONE DESCRIPTION	LARGH. (cm) WIDTH (cm)	CODICE CODE
	<p>FASCIA TAMPONAMENTO FILLER</p>	3/10	CB00P00
 <p>131,7 77,7</p>	<p>COLONNA DISPENSA 1 ANTA, 4 ripiani TALL LARDER UNIT 1 DOOR, 4 shelves</p> <p>Prof.34 Depth 34</p>	45 60 45 60 75	CD45P12 CD60P12 CD45P00 CD60P00 CD75P01

 Per strutture con gola è consigliato l'inserimento della gola verticale in entrambi i lati per una corretta apertura
For structures with groove, the introduction of the vertical groove is recommended on both sides for correct opening

 Aggiungere sempre un fianco di riporto fino a terra nel caso in cui la struttura è terminale con lato a vista
Always add a side facing down to the ground in the event that the structure is terminal with a visible side

 Struttura disponibile solo con Zoccolo H. 8 cm
Structure available only with Plinth H. 8 cm

E1	E2	E4
323	335	395
390	406	489
488	500	550
+ 15	+ 15	+ 15

E1	E2	E4
140	142	149
289	315	380
332	368	453
330	356	420
394	430	515
478	495	627

COLONNE ATTREZZATE

FITTED TALL UNITS

h.210 /p.59

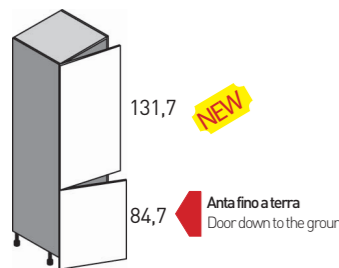
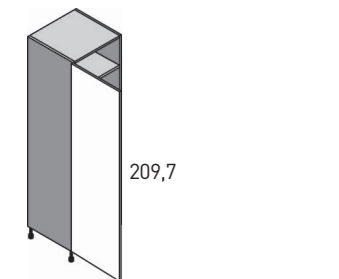
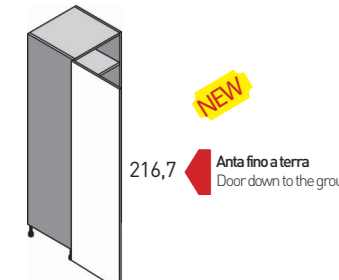
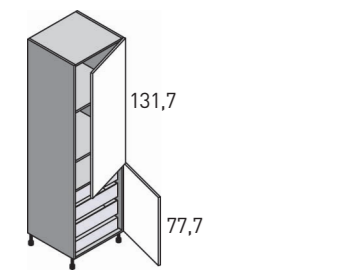
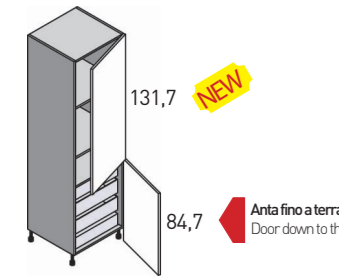
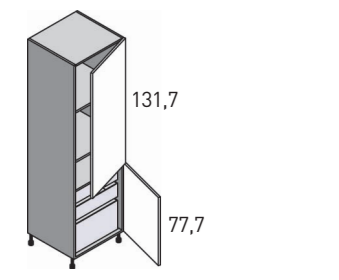
STRUTTURA STRUCTURE	DESCRIZIONE DESCRIPTION	LARGH. (cm) WIDTH (cm)	CODICE CODE
	COLONNA DISPENSA 1 ANTA, 4 ripiani TALL LARDER UNIT 1 DOOR, 4 shelves	45 60 75	CD45P23 CD60P25 CD75P03
	COLONNA DISPENSA ANTA UNICA, 5 ripiani TALL LARDER UNIT SINGLE DOOR, 5 shelves	45 60 30 45 60	CD45P17 CD60P17 CD30P04 CD45P18 CD60P18
	COLONNA DISPENSA ANTA UNICA, 5 ripiani TALL LARDER UNIT SINGLE DOOR, 5 shelves	30 45 60	CD30P09 CD45P24 CD60P26
	COLONNA DISPENSA 1 ANTA APERT. 180°, 2 ripiani e 4 cassetti interni TALL LARDER UNIT 1 DOOR 180° OPENING, 2 shelves and 4 drawers	45 60 cad. 1	CD45P13 CD60P13 GFN0060
	COLONNA DISPENSA 1 ANTA APERT. 180°, 2 ripiani e 4 cassetti interni TALL LARDER UNIT 1 DOOR 180° OPENING, 2 shelves and 4 drawers	45 60 cad. 1	CD45P25 CD60P27 GFN0060
	COLONNA DISPENSA 1 ANTA APERT. 180°, 2 ripiani e 2 cassetti 1 cesto interni TALL LARDER UNIT 1 DOOR 180° OPENING, 2 shelves and 2 drawers 1 deep-pen drawer	45 60 cad. 1	CD45P15 CD60P15 GFN0060

E1	E2	E4
392	418	487
445	474	560
529	543	673
276	291	405
303	338	455
294	311	353
333	349	462
365	399	517
329	346	388
377	394	502
426	447	570
647	674	738
681	717	802
+ 15	+ 15	+ 15
689	714	783
716	752	837
+ 15	+ 15	+ 15
604	630	695
656	691	776
+ 15	+ 15	+ 15



Aggiungere sempre un fianco di riporto fino a terra nel caso in cui la struttura è terminale con lato a vista
Always add a side facing down to the ground in the event that the structure is terminal with a visible side











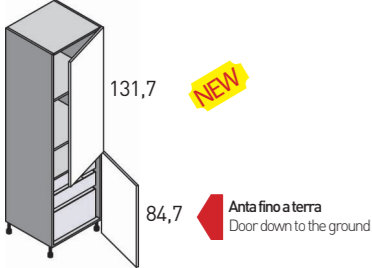

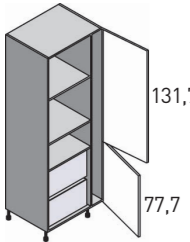
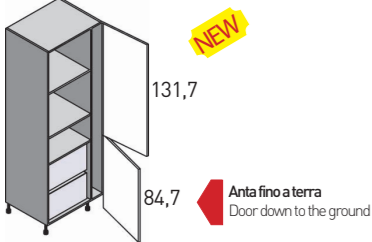
Struttura disponibile solo con Zoccolo H. 8 cm
Structure available only with Plinth H. 8 cm

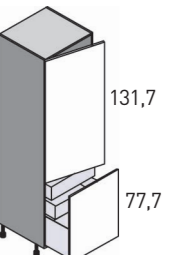
COLONNE ATTREZZATE

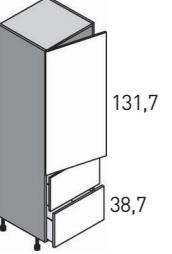
FITTED TALL UNITS

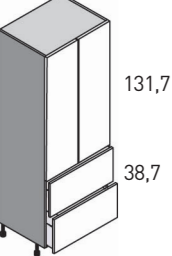
h.210 /p.59

STRUTTURA STRUCTURE	DESCRIZIONE DESCRIPTION	LARGH. (cm) WIDTH (cm)	CODICE CODE
	COLONNA DISPENSA 1 ANTA APERT. 180°, 2 ripiani e 2 cassetti 1 cesto interni TALL LARDER UNIT 1 DOOR 180° OPENING, 2 shelves and 2 drawers 1 deep-pen drawer	45	CD45P26
		60	CD60P28
	Trascinatore per cassetto interno Dragger for inner drawer	cad. 1	GFN0060
	 		
	COLONNA DISPENSA 1 ANTA APERT. 180° 2 ripiani e 2 cesti interni; struttura portascopie TALL LARDER UNIT 1 DOOR 180° OPENING, 2 shelves and 2 deep-pen drawer; broom cabinet	75	CD75P00
	COLONNA DISPENSA 1 ANTA APERT. 180° 2 ripiani e 2 cesti interni; struttura portascopie TALL LARDER UNIT 1 DOOR 180° OPENING, 2 shelves and 2 deep-pen drawer; broom cabinet	75	CD75P04
	 		
	COLONNA DISPENSA 1 CESTONE, 2 ripiani e 2 cassetti interni TALL LARDER UNIT 1 DEEP-PAN DRAWER, 2 shelves and 2 drawers	45	CD45P04
		60	CD60P04
	Trascinatore per cassetto interno Dragger for inner drawer	cad. 1	GFN0060
			
	COLONNA DISPENSA 2 CESTI, 2 ripiani TALL LARDER UNIT 2 DEEP-PAN DRAWERS, 2 shelves	45	CD45P03
		60	CD60P03
			
	COLONNA DISPENSA 2 CESTI, 2 ripiani TALL LARDER UNIT 2 DEEP-PAN DRAWERS, 2 shelves	90	CD90P03
			

E1	E2	E4
646	671	740
691	726	811
+ 15	+ 15	+ 15
804	821	953
867	881	1011
586	613	677
624	660	734
+ 15	+ 15	+ 15
478	504	567
534	567	648
655	707	844

 Per strutture con gola è consigliato l'inserimento della gola verticale in entrambi i lati per una corretta apertura
 For structures with groove, the introduction of the vertical groove is recommended on both sides for correct opening



 Aggiungere sempre un fianco di riparto fino a terra nel caso in cui la struttura è terminale con lato a vista
 Always add a side facing down to the ground in the event that the structure is terminal with a visible side

 Struttura disponibile solo con Zoccolo H. 8 cm
 Structure available only with Plinth H. 8 cm

COLONNE ATTREZZATE

FITTED TALL UNITS

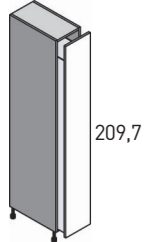
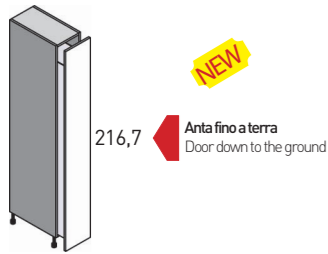
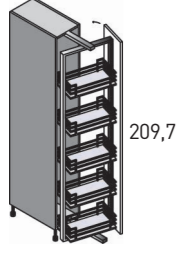
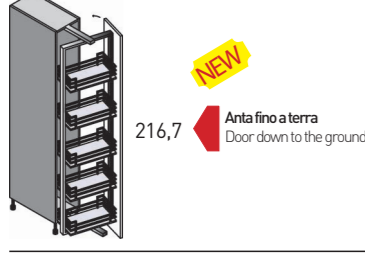
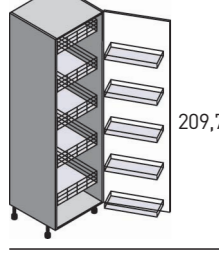
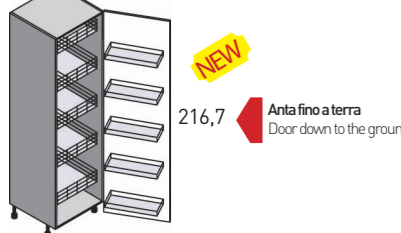
h.210 / p.59

STRUTTURA STRUCTURE	DESCRIZIONE DESCRIPTION	LARGH. (cm) WIDTH (cm)	CODICE CODE
	COLONNA ESTRAIBILE, ferramenta colore Stone o Titanio PULL-OUT TALL UNIT, colors hardware Stone orTitanio	15 30	CD15P00 CD30P00
	COLONNA ESTRAIBILE, ferramenta colore Stone o Titanio PULL-OUT TALL UNIT, colors hardware Stone orTitanio	30	CD30P10
	COLONNA ESTRAIBILE GIREVOLE, ferramenta colore Stone o Titanio PULL-OUT REVOLVING TALL UNIT, colors hardware Stone orTitanio	30	CD30P03
	COLONNA ESTRAIBILE GIREVOLE, ferramenta colore Stone o Titanio PULL-OUT REVOLVING TALL UNIT, colors hardware Stone orTitanio	30	CD30P11
	COLONNA DISPENSA APERT.180° 1 ANTA UNICA, 5 cesti interni ferramenta colore Stone o Titanio 180° OPENING TALL LARDER UNIT 1 DOOR, 5 deep-pan drawers colors hardware Stone orTitanio	45 60	CD45P19 CD60P19
	COLONNA DISPENSA APERT.180° 1 ANTA UNICA, 5 cesti interni ferramenta colore Stone o Titanio 180° OPENING TALL LARDER UNIT 1 DOOR, 5 deep-pan drawers colors hardware Stone orTitanio	45 60	CD45P27 CD60P29

 Per strutture con gola è consigliato l'inserimento della gola verticale in entrambi i lati per una corretta apertura
For structures with groove, the introduction of the vertical groove is recommended on both sides for correct opening

 Considerare spazio libero laterale di 30 cm per una apertura completa
Consider a lateral free space of 30 cm for a complete opening

 Ferramenta Galaxy Lux optional con maggiorazione; per dimensioni disponibili vedi pag. 341
Galaxy Lux hardware optional with surcharge; for available dimensions see p. 341

 Aggiungere sempre un fianco di riporto fino a terra nel caso in cui la struttura è terminale con lato a vista
Always add a side facing down to the ground in the event that the structure is terminal with a visible side

 Struttura disponibile solo con Zoccolo H. 8 cm
Structure available only with Plinth H. 8 cm

E1	E2	E4
441	456	514
728	745	787
763	780	822
1052	1068	1110
1087	1103	1145
1054	1069	1220
1150	1185	1302
1093	1110	1255
1187	1225	1340

COLONNE ATTREZZATE

FITTED TALL UNITS

h.210 /p.59

STRUTTURA STRUCTURE	DESCRIZIONE DESCRIPTION	LARGH. (cm) WIDTH (cm)	CODICE CODE
	COLONNA ATTREZZATA TOTAL VIEW APERT.180° 1 ANTA UNICA, cesti interni estraibili ferramenta colore Stone o Titanio COMPOSTA DA: - elemento a giorno "L10" terminale latereale (A) - colonna attrezzata total view apert. 180° (B) 180° OPENING EQUIPPED TOTAL VIEW TALL UNIT 1 DOOR, pull-out inner deep-pan drawers colors hardware Stone orTitanio - "L10" open element side open end (A) - 180° opening equipped total view tall unit 1 door (B)	A 30	TL59002
		B 30	CD30P08
		Totale A+B	
	COLONNA ATTREZZATA TOTAL VIEW APERT.180° 1 ANTA UNICA, cesti interni estraibili ferramenta colore Stone o Titanio COMPOSTA DA: - elemento a giorno "L10" terminale latereale (A) - colonna attrezzata total view apert. 180° (B) 180° OPENING EQUIPPED TOTAL VIEW TALL UNIT 1 DOOR, pull-out inner deep-pan drawers colors hardware Stone orTitanio - "L10" open element side open end (A) - 180° opening equipped total view tall unit 1 door (B)	A 30	TL59002
		B 30	CD30P08
		Totale A+B	



	COLONNA ATTREZZATA TOTAL VIEW APERT.180° 1 ANTA UNICA, cesti interni estraibili ferramenta colore Stone o Titanio COMPOSTA DA: - elemento a giorno "L10" terminale latereale (A) - colonna attrezzata total view apert. 180° (B) 180° OPENING EQUIPPED TOTAL VIEW TALL UNIT 1 DOOR, pull-out inner deep-pan drawers colors hardware Stone orTitanio - "L10" open element side open end (A) - 180° opening equipped total view tall unit 1 door (B)	A 30	TL59002
		B 30	CD30P12
		Totale A+B	
	COLONNA ATTREZZATA TOTAL VIEW APERT.180° 1 ANTA UNICA, cesti interni estraibili ferramenta colore Stone o Titanio COMPOSTA DA: - elemento a giorno "L10" terminale latereale (A) - colonna attrezzata total view apert. 180° (B) 180° OPENING EQUIPPED TOTAL VIEW TALL UNIT 1 DOOR, pull-out inner deep-pan drawers colors hardware Stone orTitanio - "L10" open element side open end (A) - 180° opening equipped total view tall unit 1 door (B)	A 30	TL59002
		B 30	CD30P12
		Totale A+B	



E1	E2	E4
1316	1316	1316
836	892	989
2152	2208	2305
797	797	797
836	892	989
1633	1689	1786

1316	1316	1316
878	927	1024
2194	2243	2340
797	797	797
878	927	1024
1675	1724	1821



Per colorazioni disponibili per ELEMENTI A GIORNO "L10" vedi sezione dedicata
 For colors available for "L10" OPEN ELEMENTS see the dedicated section



Considerare spazio libero laterale di 60 cm per una apertura completa
 Consider a lateral free space of 60 cm for a complete opening



Ferramenta Galaxy Lux optional con maggiorazione; per dimensioni disponibili vedi pag. 341
 Galaxy Lux hardware optional with surcharge; for available dimensions see p. 341



Aggiungere sempre un fianco di riporto fino a terra nel caso in cui la struttura è terminale con lato a vista
 Always add a side facing down to the ground in the event that the structure is terminal with a visible side







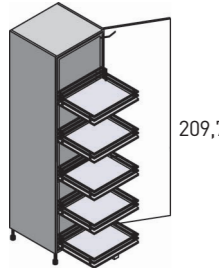

Struttura disponibile solo con Zoccolo H. 8 cm
 Structure available only with Plinth H. 8 cm

COLONNE ATTREZZATE

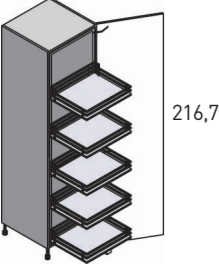
FITTED TALL UNITS

h.210 /p.59

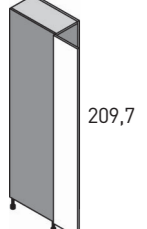
STRUTTURA STRUCTURE	DESCRIZIONE DESCRIPTION	LARGH. (cm) WIDTH (cm)	CODICE CODE
	COLONNA ATTREZZATA TOTAL VIEW 1 ANTA UNICA, - APERT. 180° per L. 30 cm - APERT. 90° per L. 45 - 60 cm cesti interni estraibili; ferramenta colore Stone o Titanio EQUIPPED TOTAL VIEW TALL UNIT 1 DOOR, - 180° OPENING for W. 30 cm - 90° OPENING for W. 45 - 60 cm pull-out inner deep-pan drawers; colors hardware Stone or Titanio  	30 45 60	CD30P07 CD45P20 CD60P20
	COLONNA ATTREZZATA TOTAL VIEW ANTE SPINATE, - APERT. 180° per L. 30 cm - APERT. 90° per L. 45 - 60 cm cesti interni estraibili; ferramenta colore Stone o Titanio EQUIPPED TOTAL VIEW TALL UNIT JOINTED DOORS, - 180° OPENING for W. 30 cm - 90° OPENING for W. 45 - 60 cm pull-out inner deep-pan drawers; colors hardware Stone or Titanio    	30 45 60	CD30P13 CD45P28 CD60P30
	STRUTTURA PORTASCOPE apertura Premi/Apri BROOM CABINET, Push/Pull opening	12/20	CB00P01

E1	E2	E4
827	844	886
855	871	1011
1004	1039	1157
862	879	921
894	911	1046
1040	1075	1195
261	263	269



Considerare spazio libero laterale di 30 cm per una apertura completa
Consider a lateral free space of 30 cm for a complete opening



Ferramenta Galaxy Lux optional con maggiorazione; per dimensioni disponibili vedi pag. 341
Galaxy Lux hardware optional with surcharge; for available dimensions see p. 341



Aggiungere sempre un fianco di riporto fino a terra nel caso in cui la struttura è terminale con lato a vista
Always add a side facing down to the ground in the event that the structure is terminal with a visible side











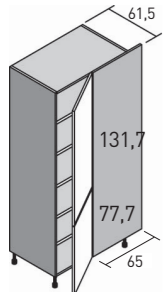

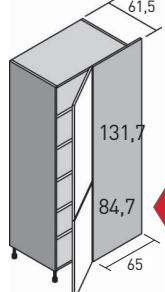

Struttura disponibile solo con Zoccolo H. 8 cm
Structure available only with Plinth H. 8 cm

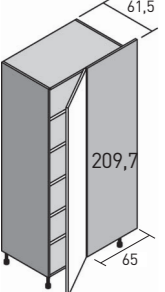
COLONNE ATTREZZATE

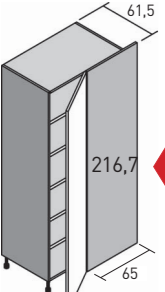

FITTED TALL UNITS

h.210 /p.59

STRUTTURA STRUCTURE	DESCRIZIONE DESCRIPTION	LARGH. (cm) WIDTH (cm)	CODICE CODE
	COLONNA ANGOLO, 4 ripiani (con tappo) CORNER TALL UNIT, 4 shelves (with cap)	scocca 90 carcass 90 110xX61,5	CA11P00
		scocca 90 carcass 90 125x61,5	CA1AP00
			
	COLONNA ANGOLO, 4 ripiani (con tappo) CORNER TALL UNIT, 4 shelves (with cap)	scocca 90 carcass 90 110 x 61,5	CA11P02
		scocca 90 carcass 90 125 x 61,5	CA1AP02
	  		
	Anta fino a terra Door down to the ground		
	COLONNA ANGOLO 1 ANTA UNICA, 4 ripiani (con tappo) CORNER TALL UNIT 1 DOOR, 4 shelves (with cap)	scocca 90 carcass 90 110xX61,5	CA11P01
		scocca 90 carcass 90 125x61,5	CA1AP01
			
	COLONNA ANGOLO 1 ANTA UNICA, 4 ripiani (con tappo) CORNER TALL UNIT 1 DOOR, 4 shelves (with cap)	scocca 90 carcass 90 110 x 61,5	CA11P03
		scocca 90 carcass 90 125 x 61,5	CA1AP03
	  		
	Anta fino a terra Door down to the ground		

MAGGIORAZIONE TAPPO A VISTA

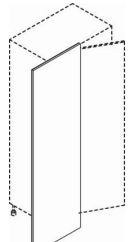
SURCHARGE FOR VISIBLE CAP

STRUTTURA STRUCTURE	DESCRIZIONE DESCRIPTION	DIMENSIONI (cm) DIMENSIONS (cm)
	MAGGIORAZIONE TAPPO A VISTA, spessore come anta (DA SOMMARE AL COSTO DELLA COLONNA ANGOLO)	H.209,7 x L 65
	SURCHARGE FOR VISIBLE CAP, thickness as a door (TO BE ADDED TO THE COST OF THE TALL CORNER UNIT)	H.215,7 x L 65
		



Aggiungere sempre un fianco di riporto fino a terra nel caso in cui la struttura è terminale con lato a vista
Always add a side facing down to the ground in the event that the structure is terminal with a visible side



Struttura disponibile solo con Zoccolo H. 8 cm
Structure available only with Plinth H. 8 cm

E1	E2	E4
473	499	563
506	541	626

515	541	610
550	579	665

453	469	582
469	503	621

494	511	619
528	549	672

TERMO STRUTTURATO THERMO TEXTURED	PET PET	LAMINATO MATERICO TEXTURED LAMINATE	FENIX FENIX
+ 82	+ 100	+ 117	+ 236
+ 82	+ 109	+ 117	+ 246

COLONNE PER FRIGO

FRIDGE TALL UNITS

h.234 / p.59

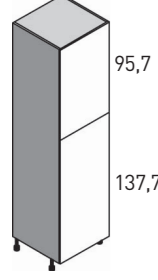
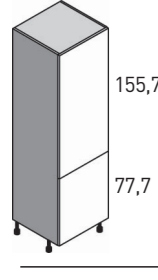
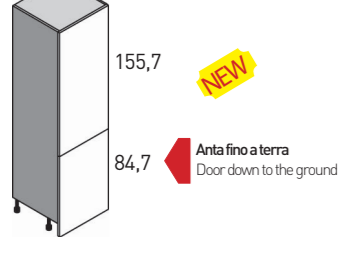
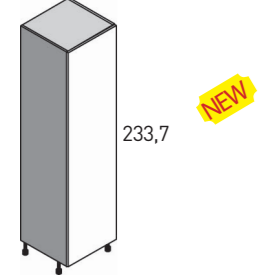
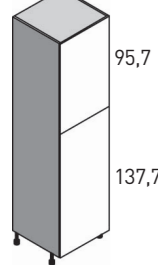
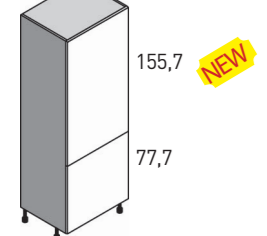
STRUTTURA STRUCTURE	DESCRIZIONE DESCRIPTION	LARGH. (cm) WIDTH (cm)	CODICE CODE
	COLONNA FRIGO 230/260 LT. TALL FRIDGE UNIT 230/260 L.	60	CQ60T00
	COLONNA FRIGO 270/330 LT. TALL FRIDGE UNIT 270/330 L.	60	CQ60T10
	COLONNA FRIGO 270/330 LT. TALL FRIDGE UNIT 270/330 L.	60	CQ60T15
	COLONNA FRIGO 270/330 LT., anta unica TALL FRIDGE UNIT 270/330 L., single door	60	CQ60T16
	COLONNA FRIGO 220 LT., sopra dispensa 1 ripiano TALL FRIDGE UNIT 220 L., over larder 1 shelf	60	CQ60T06
	COLONNA FRIGO 400 LT. TALL FRIDGE UNIT 400 L.	75	CQ75T00



Aggiungere sempre un fianco di riporto fino a terra nel caso in cui la struttura è terminale con lato a vista
Always add a side facing down to the ground in the event that the structure is terminal with a visible side



Struttura disponibile solo con Zoccolo H. 8 cm
Structure available only with Plinth H. 8 cm

E1	E2	E4
404	443	519
364	396	478
416	442	525
354	370	504
424	462	539
432	474	636

COLONNE PER FRIGO

FRIDGE TALL UNITS

h.234 /p.59

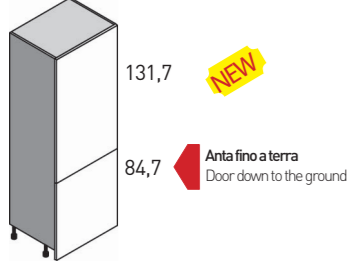
STRUTTURA STRUCTURE	DESCRIZIONE DESCRIPTION	LARGH. (cm) WIDTH (cm)	CODICE CODE
	COLONNA FRIGO 400 LT. TALL FRIDGE UNIT 400 L.	75	CQ75T01

COLONNE PER FORNO

OVEN TALL UNITS

h.234 /p.59

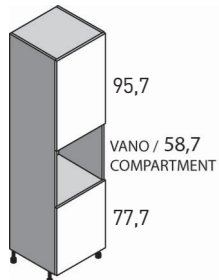
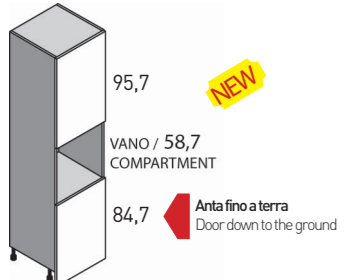
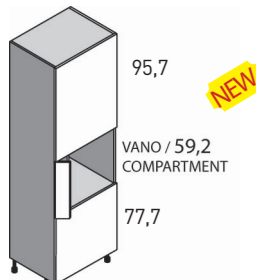
STRUTTURA STRUCTURE	DESCRIZIONE DESCRIPTION	LARGH. (cm) WIDTH (cm)	CODICE CODE
	COLONNA FORNO 1 ANTA, 4 ripiani TALL OVEN UNIT 1 DOOR, 4 shelves	60 75	CH60T00 CH75T00
	COLONNA FORNO 1 ANTA, 4 ripiani TALL OVEN UNIT 1 DOOR, 4 shelves	60 75	CH60T12 CH75T01
	COLONNA FORNO 1 ANTA, 4 ripiani VANO DA 15 CON ANTA apertura Premi/Apri TALL OVEN UNIT 1 DOOR, 4 shelves COMPARTMENT OF 15 WITH DOOR Push/Pull opening	75	CH75T02

 Possibilità di avere il vano con Anta apribile posizionato a DX o SX del vano del Forno
 Possibility of having the compartment with opening door positioned to the right or left of the oven compartment

 Aggiungere sempre un fianco di riporto fino a terra nel caso in cui la struttura è terminale con lato a vista
 Always add a side facing down to the ground in the event that the structure is terminal with a visible side

 Struttura disponibile solo con Zoccolo H. 8 cm
 Structure available only with Plinth H. 8 cm

E1	E2	E4
483	522	681

E1	E2	E4
393	418	490
458	483	603

449	468	541
509	531	649

556	583	709
-----	-----	-----

COLONNE PER FORNO

OVEN TALL UNITS

h.234 /p.59

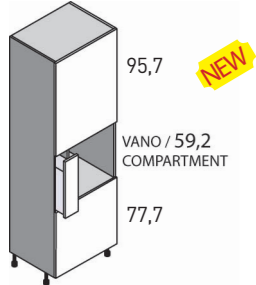
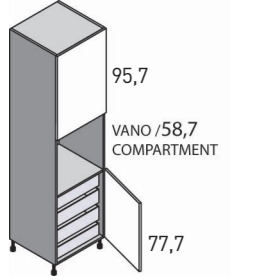
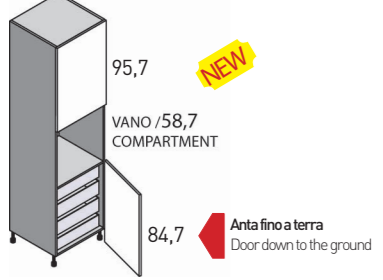
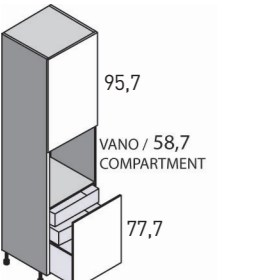
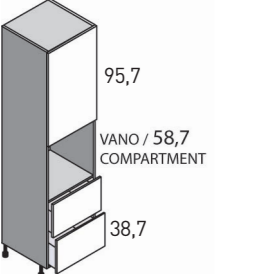
STRUTTURA STRUCTURE	DESCRIZIONE DESCRIPTION	LARGH. (cm) WIDTH (cm)	CODICE CODE
	COLONNA FORNO 1 ANTA, 4 ripiani VANO DA 15 CON ANTA ESTRAIBILE PORTATEGLIE apertura Premi/Apri TALL OVEN UNIT 1 DOOR, 4 shelves COMPARTMENT OF 15 WITH PULL-OUT DOOR TRAY HOLDER Push/Pull opening	75	CH75T04
	COLONNA FORNO 1 ANTA APERT. 180°, 2 ripiani e 4 cassetti interni TALL OVEN UNIT 1 DOOR 180° OPENING, 2 shelves and 4 drawers	60	CH60T08
	Trascinatore per cassetto interno Dragger for inner drawer	cad. 1	GFN0060
	COLONNA FORNO 1 ANTA APERT. 180°, 2 ripiani e 4 cassetti interni TALL OVEN UNIT 1 DOOR 180° OPENING, 2 shelves and 4 drawers	60	CH60T13
	Trascinatore per cassetto interno Dragger for inner drawer	cad. 1	GFN0060
	COLONNA FORNO 1 CESTONE, 2 ripiano e 2 cassetti interni TALL OVEN UNIT 1 DEEP-PAN DRAWER, 2 shelves and 2 drawers	60	CH60T04
	Trascinatore per cassetto interno Dragger for inner drawer	cad. 1	GFN0060
	COLONNA FORNO 2 CESTI, 2 ripiani OVEN TALL UNIT 2 DEEP-PAN DRAWERS, 2 shelves	60 75	CH60T05 CH75T06

E1	E2	E4
744	771	897
664	689	761
+ 15	+ 15	+ 15
720	739	811
+ 15	+ 15	+ 15
634	659	730
+ 15	+ 15	+ 15
538	561	628
608	632	739

 Per strutture con gola è consigliato l'inserimento della gola verticale in entrambi i lati per una corretta apertura
For structures with groove, the introduction of the vertical groove is recommended on both sides for correct opening

 Aggiungere sempre un fianco di riporto fino a terra nel caso in cui la struttura è terminale con lato a vista
Always add a side facing down to the ground in the event that the structure is terminal with a visible side

 Struttura disponibile solo con Zoccolo H. 8 cm
Structure available only with Plinth H. 8 cm

COLONNE PER FORNO

OVEN TALL UNITS

h.234/p.59

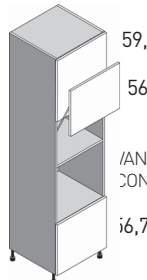
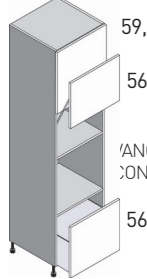
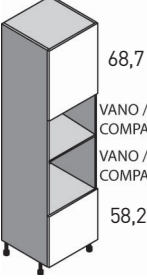
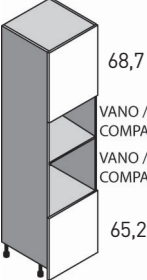
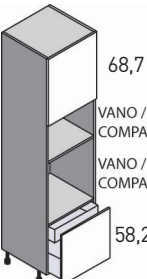
STRUTTURA STRUCTURE	DESCRIZIONE DESCRIPTION	LARGH. (cm) WIDTH (cm)	CODICE CODE
 <p>59,7 56,7 /ANO/ H.59,2 COMPARTMENT 56,7</p>	COLONNA FORNO 1 ANTA + 1 ANTA VELA, 1 ANTA INFERIORE, 2 ripiani TALL OVEN UNIT 1 DOOR + 1 DOOR SLIDE, 1 LOWER DOOR, 2 shelves	60	CH60T09
 <p>59,7 56,7 /ANO/ H.59,2 COMPARTMENT 56,7</p>	COLONNA FORNO 1 ANTA + 1 ANTA VELA, 1 CESTO INFERIORE TALL OVEN UNIT 1 DOOR + 1 DOOR SLIDE, 1 LOWER DEEP-PAN DRAWER	60	CH60T10
 <p>68,7 VANO / 45,3 COMPARTMENT VANO / 59,2 COMPARTMENT 58,2</p>	COLONNA FORNO + MICROONDE 1 ANTA, 1 ripiano OVEN + MICROWAVE OVEN TALL UNIT 1 DOOR 1 shelf	60	CM60T30
 <p>68,7 VANO / 45,3 COMPARTMENT VANO / 59,2 COMPARTMENT 65,2</p> <p>NEW</p> <p>Anta fino a terra Door down to the ground</p>	COLONNA FORNO + MICROONDE 1 ANTA, 1 ripiano OVEN + MICROWAVE OVEN TALL UNIT 1 DOOR 1 shelf	60	CM60T36
 <p>68,7 VANO / 45,3 COMPARTMENT VANO / 59,2 COMPARTMENT 58,2</p>	COLONNA FORNO + MICROONDE 1 CESTO, 1 cassetto interno OVEN + MICROWAVE OVEN TALL UNIT 1 DEEP-PAN DRAWER, 1 inner drawer	60	CM60T31
	Trascinatore per cassetto interno Dragger for inner drawer	cad. 1	GFN0060

E1	E2	E4
574	597	671
666	689	764
351	369	427
401	422	468
516	534	592
+ 15	+ 15	+ 15



Per strutture con gola è consigliato l'inserimento della gola verticale in entrambi i lati per una corretta apertura
For structures with groove, the introduction of the vertical groove is recommended on both sides for correct opening



Aggiungere sempre un fianco di riporto fino a terra nel caso in cui la struttura è terminale con lato a vista
Always add a side facing down to the ground in the event that the structure is terminal with a visible side







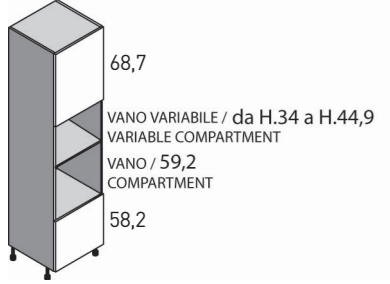

Struttura disponibile solo con Zoccolo H. 8 cm
Structure available only with Plinth H. 8 cm

COLONNE PER FORNO

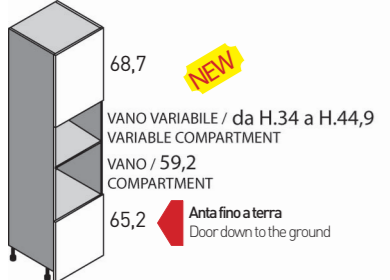
OVEN TALL UNITS

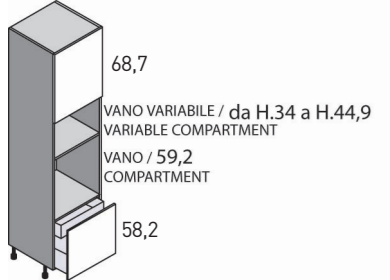
h.234/p.59

STRUTTURA STRUCTURE	DESCRIZIONE DESCRIPTION	LARGH. (cm) WIDTH (cm)	CODICE CODE
 <p>68,7 VANO VARIABILE / da H.34 a H.44,9 VARIABLE COMPARTMENT VANO / 59,2 COMPARTMENT 58,2</p>	COLONNA FORNO + MICROONDE 1 ANTA, 1 ripiano OVEN + MICROWAVE OVEN TALL UNIT 1 DOOR 1 shelf 	con massello with solid wood 60	CM60T32
 <p>68,7 NEW VANO VARIABILE / da H.34 a H.44,9 VARIABLE COMPARTMENT VANO / 59,2 COMPARTMENT 65,2 Anta fino a terra Door down to the ground</p>	COLONNA FORNO + MICROONDE 1 ANTA, 1 ripiano OVEN + MICROWAVE OVEN TALL UNIT 1 DOOR 1 shelf 	con massello with solid wood 60	CM60T37
 <p>68,7 VANO VARIABILE / da H.34 a H.44,9 VARIABLE COMPARTMENT VANO / 59,2 COMPARTMENT 58,2</p>	COLONNA FORNO + MICROONDE 1 CESTO, 1 cassetto interno OVEN + MICROWAVE OVEN TALL UNIT 1 DEEP-PAN DRAWER, 1 inner drawer 	con massello with solid wood 60	CM60T33
	Trascinatore per cassetto interno Dragger for inner drawer	cad. 1	GFN0060

COLONNE ATTREZZATE

FITTED TALL UNITS

h.234/p.59

STRUTTURA STRUCTURE	DESCRIZIONE DESCRIPTION	LARGH. (cm) WIDTH (cm)	CODICE CODE
	FASCIA TAMPONAMENTO FILLER	3/10	CB00T00
 <p>155,7 77,7</p>	COLONNA DISPENSA, 5 ripiani TALL LARDER UNIT, 5 shelves	45 60	CD45T12 CD60T12

 Per strutture con gola è consigliato l'inserimento della gola verticale in entrambi i lati per una corretta apertura
For structures with groove, the introduction of the vertical groove is recommended on both sides for correct opening

 Aggiungere sempre un fianco di riparto fino a terra nel caso in cui la struttura è terminale con lato a vista
Always add a side facing down to the ground in the event that the structure is terminal with a visible side

 Struttura disponibile solo con Zoccolo H. 8 cm
Structure available only with Plinth H. 8 cm

E1	E2	E4
342	361	427
409	431	521
507	525	592
+ 15	+ 15	+ 15

E1	E2	E4
156	158	164
392	420	462
427	459	541

COLONNE ATTREZZATE

FITTED TALL UNITS

h.234 / p.59

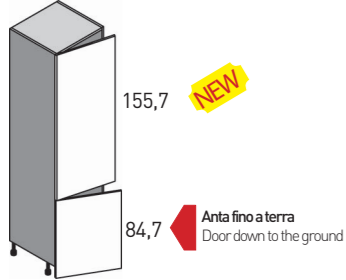
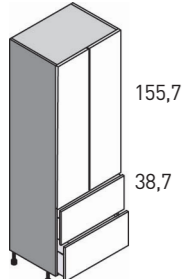
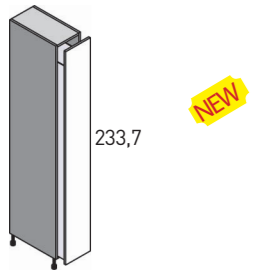
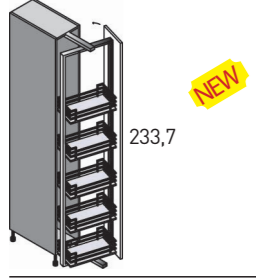
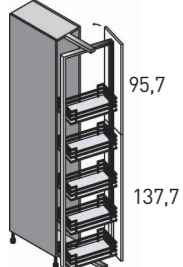
STRUTTURA STRUCTURE	DESCRIZIONE DESCRIPTION	LARGH. (cm) WIDTH (cm)	CODICE CODE
	COLONNA DISPENSA, 5 ripiani TALL LARDER UNIT, 5 shelves	45 60	CD45T21 CD60T22
	COLONNA DISPENSA 2 CESTI, 3 ripiani TALL LARDER UNIT 2 DEEP-PAN DRAWERS, 3 shelves	90	CD90T01
	COLONNA ESTRAIBILE, ferramenta colore Stone o Titanio PULL-OUT TALL UNIT, colors hardware Stone orTitanio	30	CD30T03
	COLONNA ESTRAIBILE GIREVOLE, ferramenta colore Stone o Titanio PULL-OUT REVOLVING TALL UNIT, colors hardware Stone orTitanio	30	CD30T04
	COLONNA ESTRAIBILE GIREVOLE, ante spinate ferramenta colore Stone o Titanio PULL-OUT REVOLVING TALL UNIT, jointed doors colors hardware Stone orTitanio	30	CD30T00

 Considerare spazio libero laterale di 30 cm per una apertura completa
Consider a lateral free space of 30 cm for a complete opening

 Ferramenta Galaxy Lux optional con maggiorazione; per dimensioni disponibili vedi pag. 341
Galaxy Lux hardware optional with surcharge; for available dimensions see p. 341

 Per strutture con gola è consigliato l'inserimento della gola verticale in entrambi i lati per una corretta apertura
For structures with groove, the introduction of the vertical groove is recommended on both sides for correct opening

 Aggiungere sempre un fianco di riporto fino a terra nel caso in cui la struttura è terminale con lato a vista
Always add a side facing down to the ground in the event that the structure is terminal with a visible side

 Struttura disponibile solo con Zoccolo H. 8 cm
Structure available only with Plinth H. 8 cm

E1	E2	E4
439	466	513
478	504	587
739	795	888
731	748	798
1028	1045	1096
1080	1105	1159

COLONNE ATTREZZATE

FITTED TALL UNITS

h.234/p.59

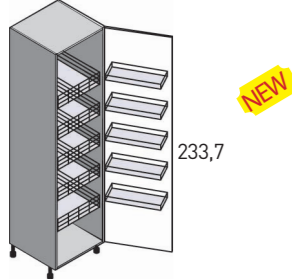
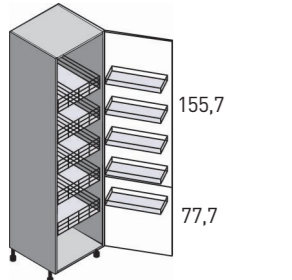
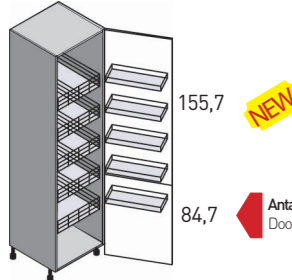
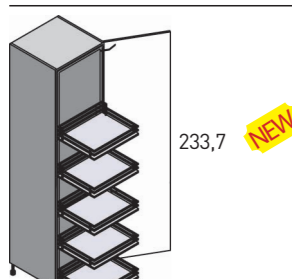
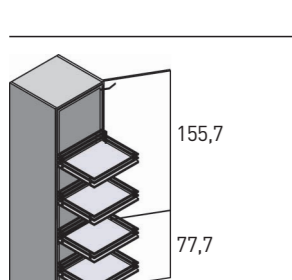
STRUTTURA STRUCTURE	DESCRIZIONE DESCRIPTION	LARGH. (cm) WIDTH (cm)	CODICE CODE
	COLONNA DISPENSA APERT.180° 1 ANTA UNICA, 5 cesti interni ferramenta colore Stone o Titanio 180° OPENING TALL LARDER UNIT 1 DOOR, 5 deep-pan drawers colors hardware Stone orTitanio	45 60	CD45T22 CD60T23
	COLONNA ATTREZZATA APERT. 180°, 5 cesti interni Ante spinate ferramenta colore Stone o Titanio 180° OPENING EQUIPPED TALL UNIT, 5 inner deep-pan drawers Jointed doors colors hardware Stone orTitanio	45 60	CD45T19 CD60T19
	COLONNA DISPENSA APERT.180° 1 ANTA UNICA, 5 cesti interni ferramenta colore Stone o Titanio 180° OPENING TALL LARDER UNIT 1 DOOR, 5 deep-pan drawers colors hardware Stone orTitanio	45 60	CD45T23 CD60T24
	COLONNA ATTREZZATA TOTAL VIEW 1 ANTA UNICA, - APERT.180° per L. 30 cm - APERT. 90° per L. 45 - 60 cm cesti interni estraibili; ferramenta colore Stone o Titanio EQUIPPED TOTAL VIEW TALL UNIT 1 DOOR, - 180° OPENING for W. 30 cm - 90° OPENING for W. 45 - 60 cm pull-out inner deep-pan drawers; colors hardware Stone or Titanio	30 45 60	CD30T05 CD45T24 CD60T25
	COLONNA ATTREZZATA TOTAL VIEW ANTE SPINATE, - APERT.180° per L. 30 cm - APERT. 90° per L. 45 - 60 cm cesti interni estraibili; ferramenta colore Stone o Titanio EQUIPPED TOTAL VIEW TALL UNIT JOINTED DOORS, - 180° OPENING for W. 30 cm - 90° OPENING for W. 45 - 60 cm pull-out inner deep-pan drawers; colors hardware Stone or Titanio	30 45 60	CD30T01 CD45T20 CD60T20

E1	E2	E4
1085	1100	1202
1173	1189	1323
1162	1190	1232
1235	1268	1350
1197	1225	1267
1271	1305	1388
814	831	881
887	901	1003
1033	1048	1183
871	896	950
958	986	1028
1089	1122	1204

 Ferramenta Galaxy Lux optional con maggiorazione; per dimensioni disponibili vedi pag. 341
Galaxy Lux hardware optional with surcharge; for available dimensions see p. 341

 Considerare spazio libero laterale di 30 cm per una apertura completa
Consider a lateral free space of 30 cm for a complete opening



 Aggiungere sempre un fianco di riporto fino a terra nel caso in cui la struttura è terminale con lato a vista
Always add a side facing down to the ground in the event that the structure is terminal with a visible side

 Struttura disponibile solo con Zoccolo H. 8 cm
Structure available only with Plinth H. 8 cm

COLONNE ATTREZZATE

FITTED TALL UNITS

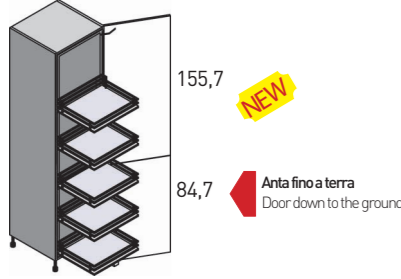
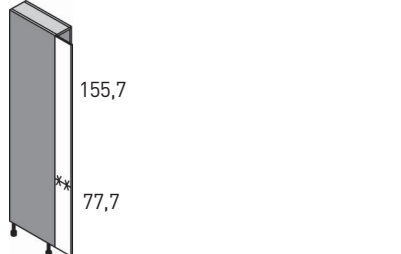
h.234 / p.59

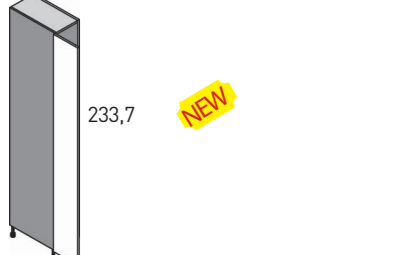
STRUTTURA STRUCTURE	DESCRIZIONE DESCRIPTION	LARGH. (cm) WIDTH (cm)	CODICE CODE
	COLONNA ATTREZZATA TOTAL VIEW ANTE SPINATE, - APERT. 180° per L. 30 cm - APERT. 90° per L. 45 - 60 cm cesti interni estraibili; ferramenta colore Stone o Titanio EQUIPPED TOTAL VIEW TALL UNIT JOINTED DOORS, - 180° OPENING for W. 30 cm - 90° OPENING for W. 45 - 60 cm pull-out inner deep-pan drawers; colors hardware Stone or Titanio	30 45 60	CD30T06 CD45T25 CD60T26
	STRUTTURA PORTASCOPE, apertura Premi/Apri Ante spinate BROOM CABINET, Push/Pull opening Jointed doors  (NO MANGILA LINEAR - NO MANIGLIA GRIP) (NO LINEAR HANDLE - NO GRIP HANDLE)	12/20	CB00T01
	STRUTTURA PORTASCOPE apertura Premi/Apri BROOM CABINET, Push/Pull opening	20	CB00T01

E1	E2	E4
913	940	985
993	1021	1063
1125	1160	1243
283	285	291
283	285	291



Considerare spazio libero laterale di 30 cm per una apertura completa
 Consider a lateral free space of 30 cm for a complete opening



Aggiungere sempre un fianco di riporto fino a terra nel caso in cui la struttura è terminale con lato a vista
 Always add a side facing down to the ground in the event that the structure is terminal with a visible side



Struttura disponibile solo con Zoccolo H. 8 cm
 Structure available only with Plinth H. 8 cm



Ferramenta Galaxy Lux optional con maggiorazione; per dimensioni disponibili vedi pag. 341
 Galaxy Lux hardware optional with surcharge; for available dimensions see p. 341

STRUTTURE CON ANTE "RETRATTILI"

STRUCTURES WITH "RETRACTING" DOORS

SCHEMA COMPOSIZIONE
COMPOSITION SCHEMATIC

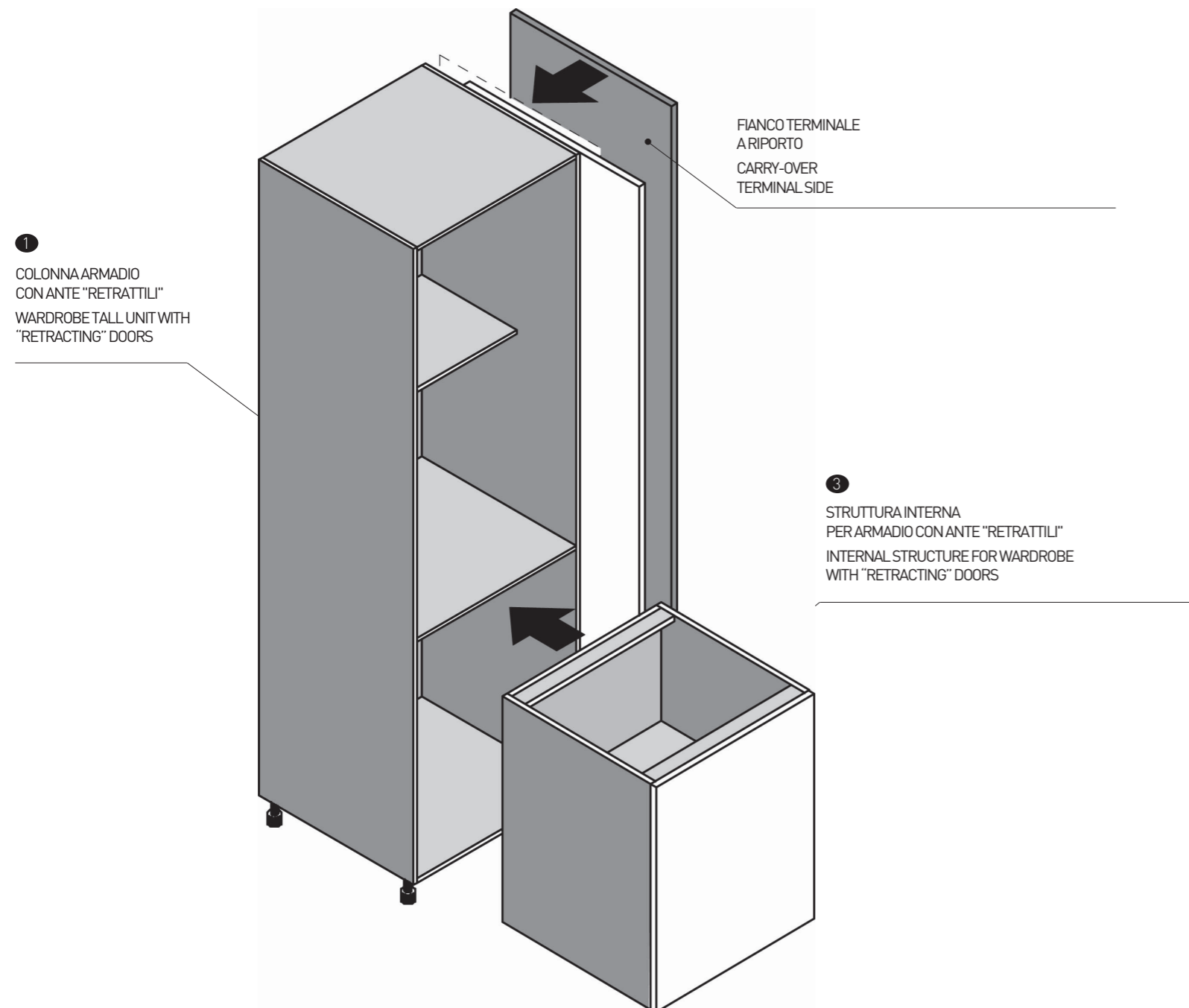

1
COLONNA ARMADIO
CON ANTE "RETRATTILI"
WARDROBE TALL UNIT WITH
"RETRACTING" DOORS

FIANCO TERMINALE
A RIPOSTO
CARRY-OVER
TERMINAL SIDE

3
STRUTTURA INTERNA
PER ARMADIO CON ANTE "RETRATTILI"
INTERNAL STRUCTURE FOR WARDROBE
WITH "RETRACTING" DOORS

STRUTTURE CON ANTE "RETRATTILI" composto da:

- 1 **COLONNA ARMADIO CON ANTE "RETRATTILI"**
- 2 **FIANCO TERMINALE A RIPOSTO (da applicare se le strutture sono a vista)**
- 3 **STRUTTURA INTERNA PER ARMADIO CON ANTE "RETRATTILI"**

STRUCTURES WITH "RETRACTING" DOORS consisting of:

- 1 **WARDROBE TALL UNIT WITH "RETRACTING" DOORS**
- 2 **CARRY-OVER TERMINAL SIDE (for use with open structures)**
- 3 **INTERNAL STRUCTURE FOR WARDROBE WITH "RETRACTING" DOORS**

REGOLE
RULES

COME SI COMPONE IL PREZZO :

Il prezzo di partenza della COLONNA ARMADIO CON ANTE "RETRATTILI" è di serie con:

- scocca Nobilitato (ROSÉ, VULCAN, WHITE)
- anta a scomparsa "Retrattili" disponibile nelle finiture dei modelli METROPOLIS
- maniglia BALANCE MRUA Titanio, interasse 320 mm (posizionata verticale laterale all'anta).

A richiesta con maggiorazione può essere scelta la COLONNA ARMADIO CON ANTE "RETRATTILI" con:

- scocca Termo Strutturato (LARICE BROWN, LARICE SABBIA, ROVERE EUCALIPTO, ROVERE SOLE, PIASENTINA SCURA, mod. METROPOLIS)
- maniglie optional sotto riportate (posizionate verticali laterali all'anta):

HOW THE PRICE IS MADE UP:

The basic price of the WARDROBE TALL UNIT WITH "RETRACTING" DOORS includes:

- Finished carcass (ROSÉ, VULCAN, WHITE)
- "retracting" hidden door available in finishes of models METROPOLIS
- BALANCE MRUA Titanio handle, centre-to-centre 320 mm (positioned vertically at side of door).

Optionally and at higher price, customers can choose the WARDROBE TALL UNIT WITH "RETRACTING" DOORS with:

- Thermo-structured carcass (LARICE BROWN, LARICE SABBIA, ROVERE EUCALIPTO, ROVERE SOLE, PIASENTINA SCURA model METROPOLIS)
- the following optional handles (positioned vertically at side of door):

Maniglia Handle	INTARASSE (mm) CENTRES (mm)	MAGGIORAZIONE SURCHARGE
		METROPOLIS
BLANCE MRU Nero Opaco Matt Black	320	-
BROOKLYN Titanio Titanium	1935	46
BROOKLYN Nero Opaco Matt Black	1935	46
LINEAR Titanio Titanium	2097	46
LINEAR Nero Opaco Matt Black	2097	46

Sommare i prezzi del FIANCO TERMINALE A RIPOSTO (qualora la struttura risulti a vista)

+

Sommare il prezzo della STRUTTURA INTERNA PER ARMADIO CON ANTE "RETRATTILI", che può essere con le ante in tutte le finiture dei modelli del programma EVOLUTION e con scocca nobilitato.

Tali strutture interne non sono disponibili di serie con maniglia POCKET Titanio; ma posso solo avere come optional il meccanismo di apertura Premi/Apri.

Add the prices of the CARRY-OVER TERMINAL SIDE (if the structure is open)

+

Add the price of the INTERNAL STRUCTURE FOR WARDROBE WITH "RETRACTING" DOORS, available with doors in all finishes of the models in the EVOLUTION range and with finished carcass.

These internal structures are not available as standard with POCKET Titanio handle, and can only have as optional the mechanism for Push/Open opening.

COLONNE ARMADIO CON ANTE "RETRATTILI"

WARDROBE TALL UNIT WITH "RETRACTING" DOORS

h.210 / p.59

STRUTTURA STRUCTURE	DESCRIZIONE DESCRIPTION	LARGH. (cm) WIDTH (cm)	CODICE CODE
 <p>SX LH</p>	<p>COLONNA 1 ANTA A SCOMPARSA, 1 ripiano VANO UTILE INTERNO L. 60 cm PREDISPOSTA PER INCASSO COLONNE H.148 PROF. 56 cm (vedi strutture dedicate a pag. 152-155) n° 1 anta H. 209,7 x L. 68,9 cm</p> <p>TALL UNIT, 1 HIDDEN DOOR, 1 inner shelf USEFUL INTERNAL COMPARTMENT W. 60 cm WITH PROVISION FOR RECESSING IN BASE CABINET H.148 D. 56 cm (see dedicated structures on page 152-155) 1 door H. 209,7 x W. 68,9 cm</p>	<p>DI SERIE STANDARD</p>	<p>Anta "Retrattili" con scocca NOBILITATO "Retracting" Door with carcass MELAMINE</p> <p>69,2</p> <p>CD69P01</p>
	<p>A RICHIESTA CON MAGGIORAZIONE ON DEMAND WHIT SURCHARGE</p>	<p>Anta "Retrattili" con scocca TERMO STRUTTURATO "Retracting" Door with carcass THERMO TEXTURED</p> <p>69,2</p>	
		<p>Anta "Retrattili" con scocca IMPIALLACCIATO "Retracting" Door with carcass VENEERED</p> <p>69,2</p>	

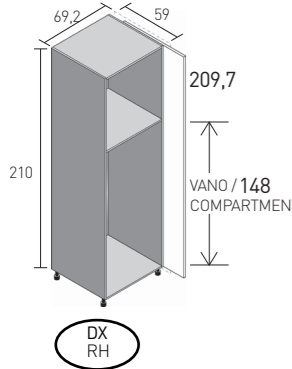

E1	E2	E4
1346	1381	1510
+ 174	+ 174	+ 174
+ 874	+ 874	+ 874

STRUTTURA STRUCTURE	DESCRIZIONE DESCRIPTION	LARGH. (cm) WIDTH (cm)	CODICE CODE
 <p>DX RH</p>	<p>COLONNA 1 ANTA A SCOMPARSA, 1 ripiano VANO UTILE INTERNO L. 60 cm PREDISPOSTA PER INCASSO COLONNE H.148 PROF. 56 cm (vedi strutture dedicate a pag. 152-155) n° 1 anta H. 209,7 x L. 68,9 cm</p> <p>TALL UNIT, 1 HIDDEN DOOR, 1 inner shelf USEFUL INTERNAL COMPARTMENT W. 60 cm WITH PROVISION FOR RECESSING IN BASE CABINET H.148 D. 56 cm (see dedicated structures on page 152-155) 1 door H. 209,7 x W. 68,9 cm</p>	<p>DI SERIE STANDARD</p>	<p>Anta "Retrattili" con scocca NOBILITATO "Retracting" Door with carcass MELAMINE</p> <p>69,2</p> <p>CD69P01</p>
	<p>A RICHIESTA CON MAGGIORAZIONE ON DEMAND WHIT SURCHARGE</p>	<p>Anta "Retrattili" con scocca TERMO STRUTTURATO "Retracting" Door with carcass THERMO TEXTURED</p> <p>69,2</p>	
		<p>Anta "Retrattili" con scocca IMPIALLACCIATO "Retracting" Door with carcass VENEERED</p> <p>69,2</p>	



E1	E2	E4
1346	1381	1510
+ 174	+ 174	+ 174
+ 874	+ 874	+ 874



Mobile di serie con: scocca Nobilitato (ROSÈ, VULCAN, WHITE) + anta a scomparsa "Retrattili" nelle finiture del modello METROPOLIS.
 Mobile a richiesta con maggiorazione: scocca Termo Strutturato (LARICE BROWN, LARICE SABBIA, ROVERE SCURO, ROVERE SOLE, PIASENTINA SCURA modello METROPOLIS)
 + anta a scomparsa "Retrattili" nelle finiture dei modelli METROPOLIS, COLOR TREND, NATURAL.
 Standard cabinet with: finished carcass (ROSÈ, VULCAN, WHITE) + "Retracting" hidden door in finish of model METROPOLIS.
 Optional cabinet with price increase: thermo-structured carcass (LARICE BROWN, LARICE SABBIA, ROVERE SCURO, ROVERE SOLE, PIASENTINA SCURA model METROPOLIS)
 + "Retracting" hidden door in finishes of models METROPOLIS, COLOR TREND, NATURAL.

COLONNE ARMADIO CON ANTE "RETRATTILI"

WARDROBE TALL UNIT WITH "RETRACTING" DOORS

h.210 / p.59

STRUTTURA STRUCTURE	DESCRIZIONE DESCRIPTION	LARGH. (cm) WIDTH (cm)	CODICE CODE	
	COLONNA 1 ANTA A SCOMPARSA, 2 ripiani VANO UTILE INTERNO L. 60 cm PREDISPOSTA PER INCASSO BASE H.78 PROF. 56 cm (vedi strutture dedicate a pag. 152-157) n° 1 anta H. 209,7 x L. 68,9 cm TALL UNIT, 1 HIDDEN DOOR, 2 inner shelves USEFUL INTERNAL COMPARTMENT W. 60 cm WITH PROVISION FOR RECESSING IN BASE CABINET H.78 D. 56 cm (see dedicated structures on page 152-157) 1 door H. 209,7 x W. 68,9 cm	DI SERIE STANDARD	Anta "Retrattili" con scocca NOBILITATO "Retracting" Door with carcass MELAMINE 69,2	CD69P00
	A RICHIESTA CON MAGGIORAZIONE ON DEMAND WHIT SURCHARGE	Anta "Retrattili" con scocca TERMO STRUTTURATO "Retracting" Door with carcass THERMO TEXTURED 69,2		
		Anta "Retrattili" con scocca IMPIALLACCIATO "Retracting" Door with carcass VENEERED 69,2		
		OPTIONAL: Mensola porta calici Inox (4 vani) sotto mensola superiore OPTIONAL: Inox Stemware Shelf (4 compartments) under upper shelf 60,1	620E060.04	

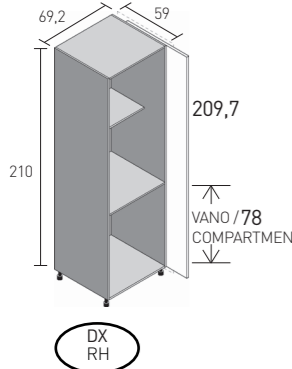

(NO MANIGLIA GRIP)
(NO GRIP HANDLE)

	COLONNA 1 ANTA A SCOMPARSA, 2 ripiani VANO UTILE INTERNO L. 60 cm PREDISPOSTA PER INCASSO BASE H.78 PROF. 56 cm (vedi strutture dedicate a pag. 152-157) n° 1 anta H. 209,7 x L. 68,9 cm TALL UNIT, 1 HIDDEN DOOR, 2 inner shelves USEFUL INTERNAL COMPARTMENT W. 60 cm WITH PROVISION FOR RECESSING IN BASE CABINET H.78 D. 56 cm (see dedicated structures on page 152-157) 1 door H. 209,7 x W. 68,9 cm	DI SERIE STANDARD	Anta "Retrattili" con scocca NOBILITATO "Retracting" Door with carcass MELAMINE 69,2	CD69P00
	A RICHIESTA CON MAGGIORAZIONE ON DEMAND WHIT SURCHARGE	Anta "Retrattili" con scocca TERMO STRUTTURATO "Retracting" Door with carcass THERMO TEXTURED 69,2		
		Anta "Retrattili" con scocca IMPIALLACCIATO "Retracting" Door with carcass VENEERED 69,2		
		OPTIONAL: Mensola porta calici Inox (4 vani) sotto mensola superiore OPTIONAL: Inox Stemware Shelf (4 compartments) under upper shelf 60,1	620E060.04	



(NO MANIGLIA GRIP)
(NO GRIP HANDLE)

E1	E2	E4
1392	1427	1557
+ 220	+ 220	+ 220
+ 1026	+ 1026	+ 1026
225	225	225

1392	1427	1557
+ 220	+ 220	+ 220
+ 1026	+ 1026	+ 1026
225	225	225



Mobili di serie con: scocca Nobilitato (ROSÈ, VULCAN, WHITE) + anta a scomparsa "Retrattili" nelle finiture del modello METROPOLIS.
 Mobile a richiesta con maggiorazione: scocca Termo Strutturato (LARICE BROWN, LARICE SABBIA, ROVERE SCURO, ROVERE SOLE, PIASENTINA SCURA modello METROPOLIS)
 + anta a scomparsa "Retrattili" nelle finiture dei modelli METROPOLIS, COLOR TREND, NATURAL.

Standard cabinet with: finished carcass (ROSÈ, VULCAN, WHITE) + "Retracting" hidden door in finish of model METROPOLIS.

Optional cabinet with price increase: thermo-structured carcass (LARICE BROWN, LARICE SABBIA, ROVERE SCURO, ROVERE SOLE, PIASENTINA SCURA model METROPOLIS)

+ "Retracting" hidden door in finishes of models METROPOLIS, COLOR TREND, NATURAL.

COLONNE ARMADIO CON ANTE "RETRATTILI"

WARDROBE TALL UNIT WITH "RETRACTING" DOORS

h.210 / p.59

STRUTTURA STRUCTURE	DESCRIZIONE DESCRIPTION	LARGH. (cm) WIDTH (cm)	CODICE CODE	
	COLONNA 2 ANTE A SCOMPARSA, 1 ripiano VANO UTILE INTERNO L. 120 cm PREDISPOSTA PER INCASSO COLONNE H.148 PROF. 56 cm (vedi strutture dedicate a pag. 152-157) n° 2 anta H. 209,7 x L. 67,1 cm TALL UNIT, 2 HIDDEN DOORS, 1 inner shelf USEFUL INTERNAL COMPARTMENT W. 120 cm WITH PROVISION FOR RECESSING IN BASE CABINET H.148 D. 56 cm (see dedicated structures on page 152-157) 2 doors H. 209,7 x W. 67,1 cm	134,8	CD13P01	
	DI SERIE STANDARD	Anta "Retrattili" con scocca NOBILITATO "Retracting" Door with carcass MELAMINE	134,8	
	A RICHIESTA CON MAGGIORAZIONE ON DEMAND WHIT SURCHARGE	Anta "Retrattili" con scocca TERMO STRUTTURATO "Retracting" Door with carcass THERMO TEXTURED	134,8	
		134,8		



	COLONNA 2 ANTE A SCOMPARSA, 1 ripiano VANO UTILE INTERNO L. 120 cm PREDISPOSTA PER INCASSO BASE H.78 PROF. 56 cm (vedi strutture dedicate a pag. 152-157) n° 2 anta H. 209,7 x L. 67,1 cm TALL UNIT, 2 HIDDEN DOORS, 1 inner shelf USEFUL INTERNAL COMPARTMENT W. 120 cm WITH PROVISION FOR RECESSING IN BASE UNIT H.78 D. 56 cm (see dedicated structures on page 152-157) 2 doors H. 209,7 x W. 67,1 cm	134,8	CD13P00	
	DI SERIE STANDARD	Anta "Retrattili" con scocca NOBILITATO "Retracting" Door with carcass MELAMINE	134,8	
	A RICHIESTA CON MAGGIORAZIONE ON DEMAND WHIT SURCHARGE	Anta "Retrattili" con scocca TERMO STRUTTURATO "Retracting" Door with carcass THERMO TEXTURED	134,8	
		134,8		
	OPTIONAL; Mensola porta calici Inox (9 vani) sotto mensola superiore OPTIONAL; Inox Stemware Shelf (9 compartments) under upper shelf	120,1	620E120.00	

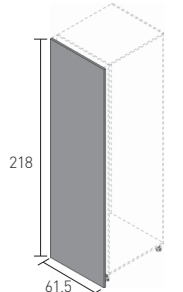

ARTICOLO ARTICLE	DESCRIZIONE DESCRIPTION	H.(cm) H.(cm)	PROF. (cm) DEPTH (cm)	CODICE CODE
	FIANCO TERMINALE PER COLONNA A RIPORTO, SP. 1,8 cm da applicare se le strutture sono a vista CARRY-OVER TERMINAL SIDE FOR TALL UNIT, TH. 1,8 cm for use with open structures	218	61,5	N216.04



Mobile di serie con: scocca Nobilitato (ROSÉ, VULCAN, WHITE) + anta a scomparsa "Retrattili" nelle finiture del modello METROPOLIS.
 Mobile a richiesta con maggiorazione: scocca Termo Strutturato (LARICE BROWN, LARICE SABBIA, ROVERE SCURO, ROVERE SOLE, PIASENTINA SCURA modello METROPOLIS)
 + anta a scomparsa "Retrattili" nelle finiture dei modelli METROPOLIS, COLOR TREND, NATURAL.

Standard cabinet with: finished carcass (ROSÉ, VULCAN, WHITE) + "Retracting" hidden door in finish of model METROPOLIS.
 Optional cabinet with price increase: thermo-structured carcass (LARICE BROWN, LARICE SABBIA, ROVERE SCURO, ROVERE SOLE, PIASENTINA SCURA model METROPOLIS)
 + "Retracting" hidden door in finishes of models METROPOLIS, COLOR TREND, NATURAL.



Fianco bifacciale disponibile in tutti i colori dei modelli ad eccezione di ALIANT e COLOR TREND il cui fianco è monofacciale
 (per colori vedere listino EVOLUTION sezione FIANCHI STRUTTURALI).

Double-sided side available in all the colors of the models except for ALIANT and COLOR TREND whose side is single-sided
 (for colours, see the EVOLUTION price list, STRUCTURAL SIDES section).

E1	E2	E4
2592	2663	2922
+ 237	+ 237	+ 237
+ 1140	+ 1140	+ 1140

2684	2756	3014
+ 329	+ 329	+ 329
+ 1443	+ 1443	+ 1443
388	388	388

NOBILITATO colore scocca MELAMINE carcass colour	TERMO STRUTTURATO THERMO TEXTURED	PET PET	LAMINATO MATERICO TEXTURED LAMINATE	FENIX FENIX
53	89	150	116	234

STRUTTURE INTERNE PER ARMADIO CON ANTE "RETRATTILI"

INTERNAL STRUCTURES FOR WARDROBE TALL UNITS WITH "RETRACTING" DOORS

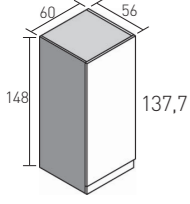
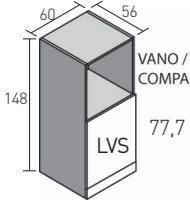
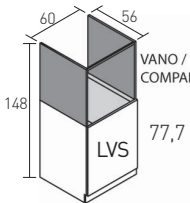
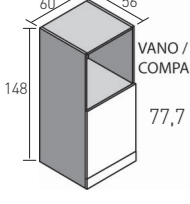
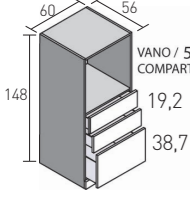
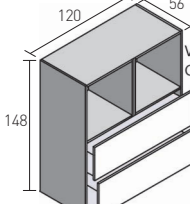
STRUTTURA STRUCTURE	DESCRIZIONE DESCRIPTION	LARGH. (cm) WIDTH (cm)	CODICE CODE
	COLONNA FRIGO 1 ANTA 225 LT., prof. 56 cm DA INCASSO NEL VANO DELLE COLONNE H. 148 anta di serie con maniglia POCKET Titanio FRIDGE TALL UNIT, 1 DOOR 225 L., d. 56 cm FOR RECESSING INSIDE TALL UNIT H. 148 standard door with POCKET Titanio handle	60	CQ60Z00
	COLONNA FORNO + LAVASTOVIGLIE (INCASSO COLONNA), prof. 56 cm DA INCASSO NEL VANO DELLE COLONNE H. 148 anta di serie con maniglia POCKET Titanio OVEN TALL UNIT + DISHWASHER (BUILT-IN TALL UNIT), d. 56 cm FOR RECESSING INSIDE TALL UNIT H. 148 standard door with POCKET Titanio handle	60	CH60Z00
	COLONNA FORNO + LAVASTOVIGLIE (INCASSO BASE), prof. 56 cm DA INCASSO NEL VANO DELLE COLONNE H. 148 anta di serie con maniglia POCKET Titanio OVEN TALL UNIT + DISHWASHER (BUILT-IN BASE UNIT), d. 56 cm FOR RECESSING INSIDE TALL UNIT H. 148 standard door with POCKET Titanio handle	60	CH60Z01
	COLONNA FORNO 1 ANTA 2 ripiani, prof. 56 cm DA INCASSO NEL VANO DELLE COLONNE H. 148 anta di serie con maniglia POCKET Titanio ; optional sistema di apertura Premi/Apri OVEN TALL UNIT, 1 DOOR 2 inner shelves, d. 56 cm FOR RECESSING INSIDE TALL UNIT H. 148 standard door with POCKET Titanio handle; optional Push/Open opening system	60	CH60Z02
	COLONNA FORNO 2 CASSETTI 1 CESTO, prof. 56 cm DA INCASSO NEL VANO DELLE COLONNE H. 148 anta di serie con maniglia POCKET Titanio ; optional sistema di apertura Premi/Apri OVEN TALL UNIT, 2 DRAWERS, 1 DEEP DRAWER, d. 56 cm FOR RECESSING INSIDE TALL UNIT H. 148 standard door with POCKET Titanio handle; optional Push/Open opening system	60	CH60Z03
	COLONNA CON DOPPIO FORNO 2 CESTI, prof. 56 cm DA INCASSO NEL VANO DELLE COLONNE H. 148 anta di serie con maniglia POCKET Titanio ; optional sistema di apertura Premi/Apri DOUBLE OVEN TALL UNIT, 2 DEEP DRAWERS, d. 56 cm FOR RECESSING INSIDE TALL UNIT H. 148 standard door with POCKET Titanio handle; optional Push/Open opening system	120	CH12Z00



Strutture disponibili con scocca nobilitata e ante in tutte le finiture dei modelli del programma EVOLUTION, ad eccezione dei modelli FRAME e ALIANT.
Non possibile inserire maniglia.

Structures available with finished carcass and doors in all the finishes of the models in the EVOLUTION range, with the exception of the FRAME and ALIANT models.
Handles cannot be added.



Inserire forno con maniglia a scomparsa o con sistema di apertura Premi/Apri
Add oven with hidden handle or Push/Open opening system



Struttura disponibile solo su colonne singole con ante "Retrattili"
Structure available only on single tall units with "Retracting" door

E1	E2	E4
262	287	369
201	213	263
160	172	222
261	272	323
446	457	503
626	649	746

STRUTTURE INTERNE PER ARMADIO CON ANTE "RETRATTILI"

INTERNAL STRUCTURES FOR WARDROBE TALL UNITS WITH "RETRACTING" DOORS

STRUTTURA STRUCTURE	DESCRIZIONE DESCRIPTION	LARGH. (cm) WIDTH (cm)	CODICE CODE
	COLONNA DISPENSA 1 ANTA 3 ripiani, prof. 56 cm DA INCASSO NEL VANO DELLE COLONNE H. 148 anta di serie con maniglia POCKET Titanio ; optional sistema di apertura Premi/Apri PANTRY TALL UNIT, 1 DOOR, 3 inner shelves, d. 56 cm FOR RECESSING INSIDE TALL UNIT H. 148 <u>standard</u> door with POCKET Titanio handle; <u>optional</u> Push/Open opening system	60	CD60Z00

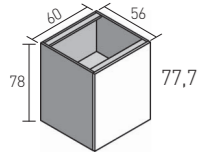

	BASE 1 ANTA 1 ripiano, prof. 56 cm DA INCASSO NEL VANO DELLE BASE H. 78 anta di serie con maniglia POCKET Titanio ; optional sistema di apertura Premi/Apri BASE CABINET, 1 DOOR, d. 56 cm FOR RECESSING INSIDE BASE CABINET H. 78 <u>standard</u> door with POCKET Titanio handle; <u>optional</u> Push/Open opening system	60	BT60H10
--	--	-----------	---------

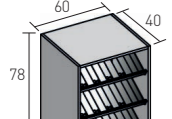

STRUTTURA STRUCTURE	DESCRIZIONE DESCRIPTION	LARGH. (cm) WIDTH (cm)	CODICE CODE
	BASE PORTABOTTIGLIE, prof. 40 cm DA INCASSO NEL VANO DELLE BASE H. 78 BOTTLE RACK BASE CABINET, prof. 40 cm FOR RECESSING INSIDE BASE CABINET H. 78	60	BM60H00



Strutture disponibili con scocca nobilitato e ante in tutte le finiture dei modelli del programma EVOLUTION, ad eccezione dei modelli FRAME e ALIANT.
Non possibile inserire maniglia.
Structures available with finished carcass and doors in all the finishes of the models in the EVOLUTION range, with the exception of the FRAME and ALIANT models.
Handles cannot be added.



Per colorazioni disponibili consultare sezione ELEMENTIA GIORNO
For available colors, see the OPEN ELEMENTS section

E1	E2	E4
----	----	----

280	305	387
------------	------------	------------

195	205	247
------------	------------	------------

NOBILITATO colore scocca MELAMINE carcass colour	TERMO STRUTTURATO THERMO TEXTURED	PET PET	LAMINATO MATERICO TEXTURED LAMINATE	FENIX FENIX
630	927	875	672	710

COLONNE ARMADIO CON ANTE "RETRATTILI"

WARDROBE TALL UNIT WITH "RETRACTING" DOORS

h.210 / p.59

STRUTTURA STRUCTURE	DESCRIZIONE DESCRIPTION	LARGH. (cm) WIDTH (cm)	CODICE CODE			
	<p>COLONNA 1 ANTA A SCOMPARSA PREDISPOSTA PER INCASSO BASE H.78 PROF. 56 cm n° 1 anta H. 209,7 x L. 68,9 cm (vedi strutture dedicate a pag. 152-157) DOTATA DI SERIE DI:</p> <ul style="list-style-type: none"> - Mensola Inox predisposta per luce a LED 4000K A - Schienale Work-station con n°5 ganci e prese di corrente B - Kit prese power + USB 2.1 B - N° 1 Ripiano estraibile Inox C <p>TALL UNIT, 1 HIDDEN DOOR WITH PROVISION FOR RECESSING IN BASE CABINET H.78 D. 56 cm 1 door H. 209,7 x W. 68,9 cm (see dedicated structures on page 152-157) EQUIPPED AS STANDARD WITH:</p> <ul style="list-style-type: none"> - Stainless steel shelf with provision for 4000K LED light A - Work-station back with 5 hooks and power sockets B - Power socket + USB 2.1 kit B - 1 Pull-out stainless steel inner shelf C 	<p>DI SERIE STANDARD</p> <p>A RICHIESTA CON MAGGIORAZIONE ON DEMAND WHIT SURCHARGE</p>	<p>Anta "Retrattili" con scocca NOBILITATO "Retracting" Door with carcass MELAMINE</p> <p>Anta "Retrattili" con scocca TERMO STRUTTURATO "Retracting" Door with carcass THERMO TEXTURED</p> <p>Anta "Retrattili" con scocca IMPIALLACCIATO "Retracting" Door with carcass VENEERED</p> <p>MAGGIORAZIONE: Kit automazione per ripiano estraibile SURCHARGE: Automation kit for pull-out shelf</p> <p>OPTIONAL: Kit luce sensor 4000K per mensola Inox OPTIONAL: 4000K sensor light kit for stainless steel shelf</p>	<p>69,2</p> <p>69,2</p> <p>69,2</p> <p>200AP60036</p>	<p>CD69P02</p>	
				2917	2953	3082
				+ 154	+ 154	+ 154
				+ 872	+ 872	+ 872
			+ 1617	+ 1617	+ 1617	
			139	139	139	



	<p>COLONNA 1 ANTA A SCOMPARSA PREDISPOSTA PER INCASSO BASE H.78 PROF. 56 cm n° 1 anta H. 209,7 x L. 68,9 cm (vedi strutture dedicate a pag. 152-157) DOTATA DI SERIE DI:</p> <ul style="list-style-type: none"> - Mensola Inox predisposta per luce a LED 4000K A - Schienale Work-station con n°5 ganci e prese di corrente B - Kit prese power + USB 2.1 B - N° 1 Ripiano estraibile Inox C <p>TALL UNIT, 1 HIDDEN DOOR WITH PROVISION FOR RECESSING IN BASE CABINET H.78 D. 56 cm 1 door H. 209,7 x W. 68,9 cm (see dedicated structures on page 152-157) EQUIPPED AS STANDARD WITH:</p> <ul style="list-style-type: none"> - Stainless steel shelf with provision for 4000K LED light A - Work-station back with 5 hooks and power sockets B - Power socket + USB 2.1 kit B - 1 Pull-out stainless steel inner shelf C 	<p>DI SERIE STANDARD</p> <p>A RICHIESTA CON MAGGIORAZIONE ON DEMAND WHIT SURCHARGE</p>	<p>Anta "Retrattili" con scocca NOBILITATO "Retracting" Door with carcass MELAMINE</p> <p>Anta "Retrattili" con scocca TERMO STRUTTURATO "Retracting" Door with carcass THERMO TEXTURED</p> <p>Anta "Retrattili" con scocca IMPIALLACCIATO "Retracting" Door with carcass VENEERED</p> <p>MAGGIORAZIONE: Kit automazione per ripiano estraibile SURCHARGE: Automation kit for pull-out shelf</p> <p>OPTIONAL: Kit luce sensor 4000K per mensola Inox OPTIONAL: 4000K sensor light kit for stainless steel shelf</p>	<p>69,2</p> <p>69,2</p> <p>69,2</p> <p>200AP60036</p>	<p>CD69P02</p>	
				2917	2953	3082
				+ 154	+ 154	+ 154
				+ 872	+ 872	+ 872
			+ 1617	+ 1617	+ 1617	
			139	139	139	



- 22** Mobile di serie con: scocca Nobilitato (ROSÈ, VULCAN, WHITE) + anta a scomparsa "Retrattili" nelle finiture del modello METROPOLIS.
 Mobile a richiesta con maggiorazione: scocca Termo Strutturato (LARICE BROWN, LARICE SABBIA, ROVERE SCURO, ROVERE SOLE, PIASENTINA SCURA, modello METROPOLIS)
 + anta a scomparsa "Retrattili" nelle finiture dei modelli METROPOLIS, COLOR TREND, NATURAL.
 Standard cabinet with: finished carcass (ROSÈ, VULCAN, WHITE) + "Retracting" hidden door in finish of model METROPOLIS.
 Optional cabinet with price increase: thermo-structured carcass (LARICE BROWN, LARICE SABBIA, ROVERE SCURO, ROVERE SOLE, PIASENTINA SCURA, model METROPOLIS)
 + "Retracting" hidden door in finishes of models METROPOLIS, COLOR TREND, NATURAL.
- 28** Kit luce sensor 4000K per mensola Inox da scegliere nella versione Europea o nella versione Americana
 4000K sensor light kit for stainless steel shelf, to specify European or American voltage
- 29** Kit prese power + USB 2.1 da scegliere nella versione Europea o nella versione Americana
 Power socket + USB 2.1 kit, to specify European, American

E1	E2	E4
2917	2953	3082
+ 154	+ 154	+ 154
+ 872	+ 872	+ 872
+ 1617	+ 1617	+ 1617
139	139	139

2917	2953	3082
+ 154	+ 154	+ 154
+ 872	+ 872	+ 872
+ 1617	+ 1617	+ 1617
139	139	139

COLONNE ARMADIO CON ANTE "RETRATTILI"

WARDROBE TALL UNIT WITH "RETRACTING" DOORS

h.210 / p.59

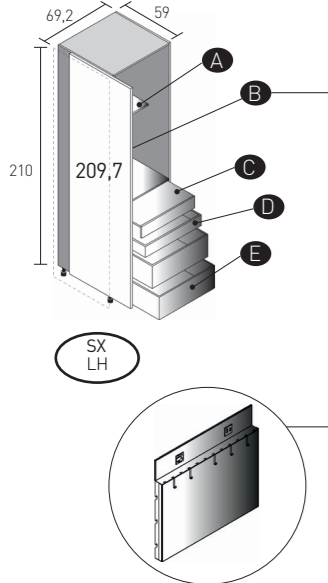
STRUTTURA STRUCTURE	DESCRIZIONE DESCRIPTION	LARGH. (cm) WIDTH (cm)	CODICE CODE
	COLONNA 1 ANTA A SCOMPARSA n° 1 anta H. 209,7 x L. 68,9 cm DOTATA DI SERIE DI: - Mensola Inox predisposta per luce a LED 4000K A - Schienale Work-station con n°5 ganci e prese di corrente B - Kit prese power + USB 2.1 B - N° 1 Ripiano estraibile Inox C - N° 1 Cassetto interno Inox D - N° 2 Cesti interni Inox E	69,2	CD69P03
	TALL UNIT, 1 HIDDEN DOOR 1 door H. 209,7 x W. 68,9 cm EQUIPPED AS STANDARD WITH: - Stainless steel shelf with provision for 4000K LED light A - Work-station back with 5 hooks and power sockets B - Power socket + USB 2.1 kit B - 1 Pull-out stainless steel inner shelf C - 1 Stainless steel inner drawer D - 2 Stainless steel inner shelves E	69,2	
	DI SERIE STANDARD Anta "Retrattili" con scocca NOBILITATO "Retracting" Door with carcass MELAMINE	69,2	
	A RICHIESTA CON MAGGIORAZIONE ON DEMAND WHIT SURCHARGE Anta "Retrattili" con scocca TERMO STRUTTURATO "Retracting" Door with carcass THERMO TEXTURED	69,2	
	MAGGIORAZIONE: Kit automazione per ripiano estraibile SURCHARGE: Automation kit for pull-out shelf	69,2	
	OPTIONAL: Kit luce sensor 4000K per mensola Inox OPTIONAL: 4000K sensor light kit for stainless steel shelf		200AP60036

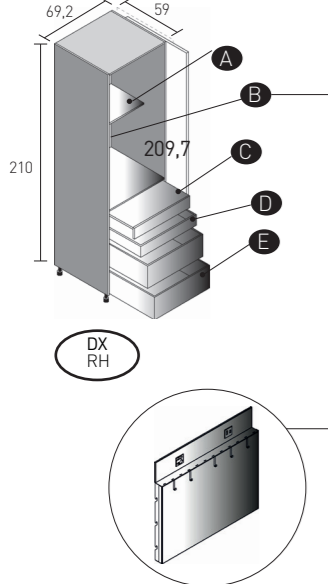

	COLONNA 1 ANTA A SCOMPARSA n° 1 anta H. 209,7 x L. 68,9 cm DOTATA DI SERIE DI: - Mensola Inox predisposta per luce a LED 4000K A - Schienale Work-station con n°5 ganci e prese di corrente B - Kit prese power + USB 2.1 B - N° 1 Ripiano estraibile Inox C - N° 1 Cassetto interno Inox D - N° 2 Cesti interni Inox E	69,2	CD69P03
	TALL UNIT, 1 HIDDEN DOOR 1 door H. 209,7 x W. 68,9 cm EQUIPPED AS STANDARD WITH: - Stainless steel shelf with provision for 4000K LED light A - Work-station back with 5 hooks and power sockets B - Power socket + USB 2.1 kit B - 1 Pull-out stainless steel inner shelf C - 1 Stainless steel inner drawer D - 2 Stainless steel inner shelves E	69,2	
	DI SERIE STANDARD Anta "Retrattili" con scocca NOBILITATO "Retrattili" Door with carcass MELAMINE	69,2	
	A RICHIESTA CON MAGGIORAZIONE ON DEMAND WHIT SURCHARGE Anta "Retrattili" con scocca TERMO STRUTTURATO "Retracting" Door with carcass THERMO TEXTURED	69,2	
	MAGGIORAZIONE: Kit automazione per ripiano estraibile SURCHARGE: Automation kit for pull-out shelf	69,2	
	OPTIONAL: Kit luce sensor 4000K per mensola Inox OPTIONAL: 4000K sensor light kit for stainless steel shelf		200AP60036



Mobile di serie con: scocca Nobilitato (ROSÈ, VULCAN, WHITE) + anta a scomparsa "Retrattili" nelle finiture del modello METROPOLIS.
 Mobile a richiesta con maggiorazione: scocca Termo Strutturato (LARICE BROWN, LARICE SABBIA, ROVERE SCURO, ROVERE SOLE, PIASENTINA SCURA modello METROPOLIS)
 + anta a scomparsa "Retrattili" nelle finiture dei modelli METROPOLIS, COLOR TREND, NATURAL.

Standard cabinet with: finished carcass (ROSÈ, VULCAN, WHITE) + "Retracting" hidden door in finish of model METROPOLIS.
 Optional cabinet with price increase: thermo-structured carcass (LARICE BROWN, LARICE SABBIA, ROVERE SCURO, ROVERE SOLE, PIASENTINA SCURA model METROPOLIS)
 + "Retracting" hidden door in finishes of models METROPOLIS, COLOR TREND, NATURAL.



Kit luce sensor 4000K per mensola Inox da scegliere nella versione Europea o nella versione Americana
 4000K sensor light kit for stainless steel shelf, to specify European or American voltage



Kit prese power + USB 2.1 da scegliere nella versione Europea o nella versione Americana
 Power socket + USB 2.1 kit, to specify European, American

E1	E2	E4
4628	4664	4793
+ 164	+ 164	+ 164
+ 973	+ 973	+ 973
+ 1617	+ 1617	+ 1617
139	139	139

4628	4664	4793
+ 164	+ 164	+ 164
+ 973	+ 973	+ 973
+ 1617	+ 1617	+ 1617
139	139	139

COLONNE ARMADIO CON ANTE "RETRATTILI"

WARDROBE TALL UNIT WITH "RETRACTING" DOORS

h.210 / p.59

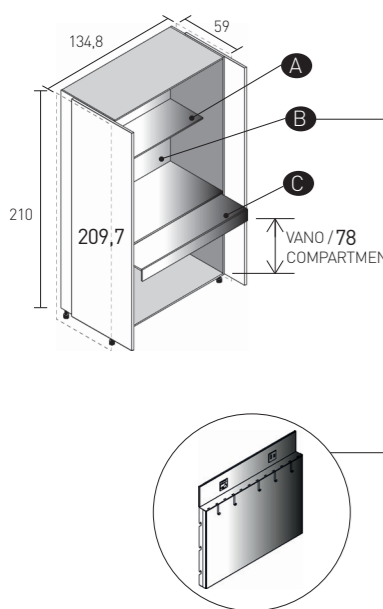
STRUTTURA STRUCTURE	DESCRIZIONE DESCRIPTION	LARGH. (cm) WIDTH (cm)	CODICE CODE
	COLONNA 2 ANTE A SCOMPARSA PREDISPOSTA PER INCASSO BASE H.78 PROF. 56 cm n° 2 anta H. 209,7 x L. 67,1 cm (vedi strutture dedicate a pag. 152-157) DOTATA DI SERIE DI: <ul style="list-style-type: none"> - Mensola Inox predisposta per luce a LED 4000K A - Schienale Work-station con n°5 ganci e prese di corrente B - Kit prese power + USB 2.1 B - N° 1 Ripiano estraibile Inox C 	134,8	CD13P02
	DI SERIE STANDARD Anta "Retrattili" con scocca NOBILITATO "Retracting" Door with carcass MELAMINE	134,8	
	A RICHIESTA CON MAGGIORAZIONE ON DEMAND WHIT SURCHARGE Anta "Retrattili" con scocca TERMO STRUTTURATO "Retracting" Door with carcass THERMO TEXTURED	134,8	
	Anta "Retrattili" con scocca IMPIALLACCIATO "Retracting" Door with carcass VENEERED	134,8	
	MAGGIORAZIONE: Kit automazione per ripiano estraibile SURCHARGE: Automation kit for pull-out shelf		
OPTIONAL: Kit luce sensor 4000K per mensola Inox OPTIONAL: 4000K sensor light kit for stainless steel shelf		200AP12036	

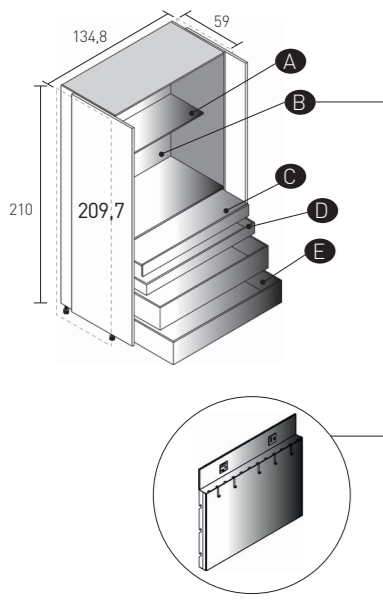

	COLONNA 2 ANTE A SCOMPARSA n° 2 anta H. 209,7 x L. 67,1 cm DOTATA DI SERIE DI: <ul style="list-style-type: none"> - Mensola Inox predisposta per luce a LED 4000K A - Schienale Work-station con n°5 ganci e prese di corrente B - Kit prese power + USB 2.1 B - N° 1 Ripiano estraibile Inox C - N° 1 Cassetto interno Inox D - N° 2 Cesti interni Inox E 	134,8	CD13P03
	DI SERIE STANDARD Anta "Retrattili" con scocca NOBILITATO "Retracting" Door with carcass MELAMINE	134,8	
	A RICHIESTA CON MAGGIORAZIONE ON DEMAND WHIT SURCHARGE Anta "Retrattili" con scocca TERMO STRUTTURATO "Retracting" Door with carcass THERMO TEXTURED	134,8	
	Anta "Retrattili" con scocca IMPIALLACCIATO "Retracting" Door with carcass VENEERED	134,8	
	MAGGIORAZIONE: Kit automazione per ripiano estraibile SURCHARGE: Automation kit for pull-out shelf		
OPTIONAL: Kit luce sensor 4000K per mensola Inox OPTIONAL: 4000K sensor light kit for stainless steel shelf		200AP12036	



Mobile di serie con: scocca Nobilitato (ROSÈ, VULCAN, WHITE) + anta a scomparsa "Retrattili" nelle finiture del modello METROPOLIS.
 Mobile a richiesta con maggiorazione: scocca Termo Strutturato (LARICE BROWN, LARICE SABBIA, ROVERE SCURO, ROVERE SOLE, PIASENTINA SCURA modello METROPOLIS)
 + anta a scomparsa "Retrattili" nelle finiture dei modelli METROPOLIS, COLOR TREND, NATURAL

Standard cabinet with: finished carcass (ROSÈ, VULCAN, WHITE) + "Retracting" hidden door in finish of model METROPOLIS.
 Optional cabinet with price increase: thermo-structured carcass (LARICE BROWN, LARICE SABBIA, ROVERE SCURO, ROVERE SOLE, PIASENTINA SCURA model METROPOLIS)
 + "Retracting" hidden door in finishes of models METROPOLIS, COLOR TREND, NATURAL



Kit luce sensor 4000K per mensola Inox da scegliere nella versione Europea o nella versione Americana
 4000K sensor light kit for stainless steel shelf, to specify European or American voltage



Kit prese power + USB 2.1 da scegliere nella versione Europea o nella versione Americana
 Power socket + USB 2.1 kit, to specify European, American





E1	E2	E4
4511	4583	4841
+ 199	+ 199	+ 199
+ 1135	+ 1135	+ 1135
+ 1617	+ 1617	+ 1617
178	178	178

6861	6933	7191
+ 218	+ 218	+ 218
+ 1337	+ 1337	+ 1337
+ 1617	+ 1617	+ 1617
178	178	178

COLONNE ARMADIO CON ANTE "RETRATTILI"

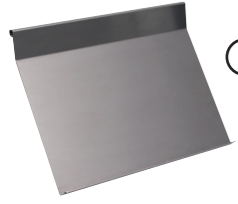
WARDROBE TALL UNIT WITH "RETRACTING" DOORS

h.210 /p.59

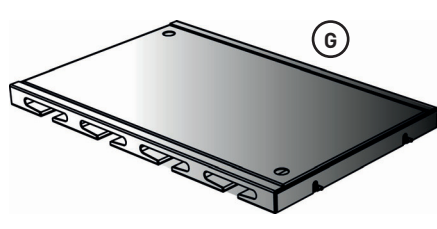
ARTICOLO ARTICLE	DESCRIZIONE DESCRIPTION	LARGH. (cm) WIDTH (cm)	H. (cm) H. (cm)	CODICE CODE	INOX STEEL
ACCESSORI PER STRUTTURE CON SCHIENALE WORK-STATION ACCESSORIES FOR STRUCTURES WITH WORK-STATION BACK					
 A	A - Coppia Tagliere in PET A - Pair of PET cutting boards	52	60	200TOW6000	131
 B	B - Porta tablet Inox B - Stainless steel tablet holder			200TOW5000	131
 C	C - Porta Spezie Inox C - Stainless steel spice holder			200TOW3000	366
 D	D - Porta Coltelli Inox D - Stainless steel knife holder	21	40	200TOW2000	209
 E	E - Porta Rotolo Inox E - Stainless steel foil holder	21	40	200TOW4000	292
 F	F - Porta mattarello con mattarello in PET F - PET rolling pin holder with rolling pin	60	40	200TOW1000	139
 G	G - Mensola portacalici Inox G - Stainless steel stemware shelf	60,1 120,1	3,4 3,4	620E060.04 620E120.00	225 388

LAMPADE

LAMPS

**INSIDER ,
con alimentatore**
INSIDER,
power supply unit**FINITURA
FINISHES**

Nero

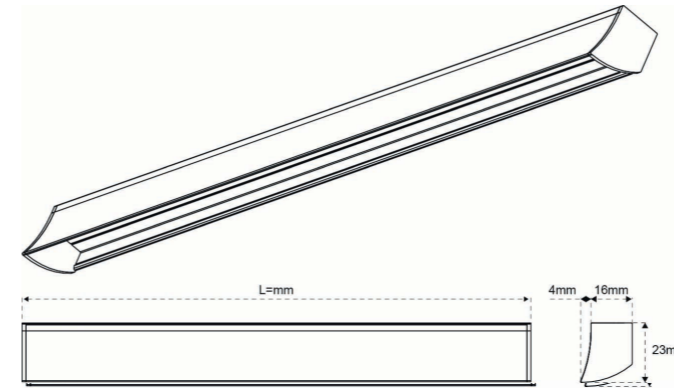
Completa di interruttore infrarosso per
accensione e spegnimento automatico.Complete with infrared switch for automatic
switching on and off.

- Alimentatore associato: TIPO F

- Associated power supply unit : TYPE F

FINITURA FINISHES	L. (cm) W. (cm)	P. (cm) D. (cm)	H. (cm) H. (cm)	POTENZA - TEMPERATURA COLORE POWER - COLOR TEMPERATURE	CODICE CODE	PTS.
NERO	60	2	2,3	7,2W - 3000÷4000K	200AP60035	160
NERO	120	2	2,3	15W - 3000÷4000K	200AP12035	181

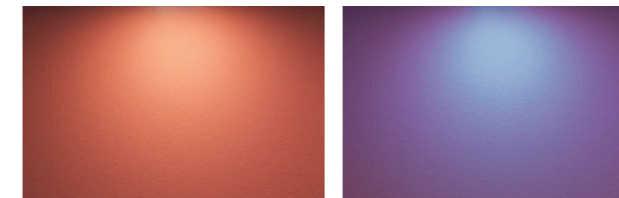
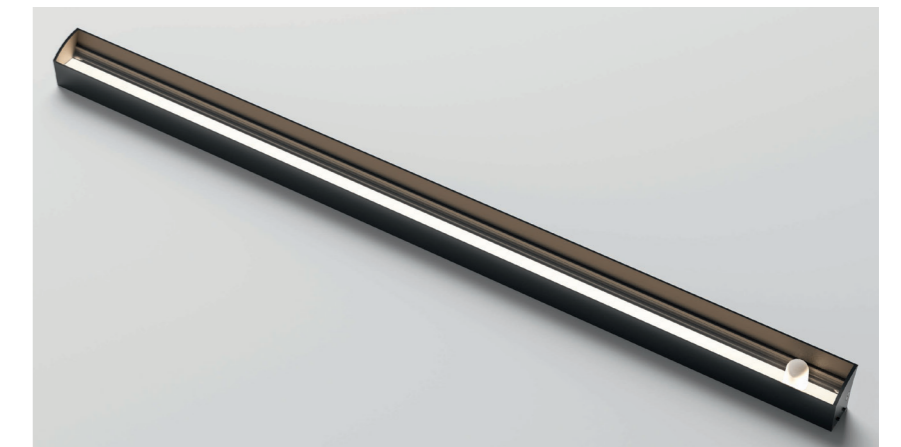
EMOTION DUAL COLORLuce Calda
Warm LightLuce Fredda
Natural Light

Complementi

Complements

FIANCHI / SIDES

MENSOLE /SHELVES

PANNELLI E SCHIENALI /PANELS AND BACK PANELS

CAPPE ESTETICHE /AESTHETIC HOODS

ELEMENTI A GIORNO /OPEN ELEMENTS

ELEMENTI A GIORNO "L10" /"L10" OPEN ELEMENTS

VANI A GIORNO "L10" - NICCHIE IN METALLO /"L10" VAIN OPEN - NICHE IN METAL

ELEMENTI IN METALLO /METAL ELEMENTS

ELEMENTI A GIORNO SIZE / SIZE OPEN ELEMENTS

ELEMENTI PALO ALTO /PALO ALTO ELEMENTS

COMBO LINE /COMBO LINE

MANIGLIA LINEAR /HANDLE LINEAR

MANIGLIA GRIP /HANDLE GRIP

MANIGLIE/HANDLES

GOLA SCAVATA/GROOVE DUG

GOLA PIATTA/GROOVE FLAT

ELEMENTI PER GOLA /ELEMENTS FOR GROOVE

ZOCCOLI /PLINTH

RICAMBI PER ANTE /SPARES FOR DOORS

MAGGIORAZIONI /SURCHARGE

INFO UTILI /INFORMATIONS UTILES

FIANCHI STRUTTURALI - FIANCHI A RIPORTO

STRUCTURAL SIDE PANELS - END PANELS

TIPOLOGIA MATERIALE TYPE OF MATERIAL	COLORI COLOURS	DISPONIBILE NEI MODELLI AVAILABLE IN MODELS
NOBILITATO colore scocca MELAMINE carcass colour	ROSÉ VULCAN WHITE	UNIVERSALE UNIVERSAL
BIFACCIALE DOUBLE - FACE		
LAMINATO MATERICO TEXTURED LAMINATE	CALCE CEMENTO CEMENTO BIANCO NERO MARQUINIA CEMENTO VISIONE	METROPOLIS
BIFACCIALE DOUBLE - FACE	CEMENTO DARK PIASENTINA SCURA	
	GRAFITE BROWN	METROPOLIS - ALIANT
PET PET	BIANCO ASSOLUTO LUCIDO BIANCO ASSOLUTO OPACO CACHEMERE LUCIDO CACHEMERE OPACO GRIGIO FUMO OPACO NEBBIA OPACO	METROPOLIS
BIFACCIALE DOUBLE - FACE	GRIGIO FREDDO OPACO GRAU OPACO NERO OPACO CAFFÈ OPACO CANNA DI FUCILE OPACO GINSENG OPACO	
	BEIGE SETA OPACO	

FIANCHI STRUTTURALI - FIANCHI A RIPORTO

STRUCTURAL SIDE PANELS - END PANELS

TIPOLOGIA MATERIALE TYPE OF MATERIAL	COLORI COLOURS	DISPONIBILE NEI MODELLI AVAILABLE IN MODELS
TERMOSTRUTTURATO THERMO STRUCTURED	LARICE BROWN LARICE SABBIA NOCE EUCALIPTO ROVERE SOLE ROVERE NODATO ROVERE NATURA	METROPOLIS
BIFACCIALE DOUBLE - FACE		
FENIX FENIX	GRIGIO LONDRA GRIGIO EFESO NERO INGO GRIGIO BROMO BIANCO KOS BEIGE ARIZONA	METROPOLIS
BIFACCIALE DOUBLE - FACE	GRIGIO ANTRIM ROSSO JAIPUR VERDE COMODORO CASTORO OTTAWA CACAO ORINOCO BLUFES	

MAGGIORAZIONE PER FIANCHI STRUTTURALI

SURCHARGE FOR STRUCTURAL SIDES

FIANCHI IN SOSTITUZIONE A QUELLI PRESENTI NELLA SCOCCA DI SERIE DEL MOBILE, SENZA FARE NESSUNO SPESSORE
SIDE PANELS TO REPLACE THOSE ON THE UNIT'S STANDARD CARCASS, WITHOUT ANY INCREASE IN THICKNESS

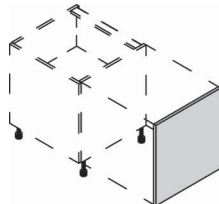
ARTICOLO ARTICLE	DESCRIZIONE Description	H.(cm) H.(cm)	PROF. (cm) DEPTH (cm)	
	FIANCO PER BASI SIDE PANEL FOR BASE UNITS	per basi for base units.	78 / 81	34
		per basi for base units.	78 / 81	59
		per basi for base units.	78 / 81	72
		per basi sospese o ribassate for lowered and suspended base units.	19,5 / 21,75	47
		per basi sospese o ribassate for lowered and suspended base units.	19,5 / 21,75	59
		per basi sospese o ribassate for lowered and suspended base units.	39 / 40,5	34
		per basi sospese o ribassate for lowered and suspended base units.	39 / 40,5	47
		per basi sospese o ribassate for lowered and suspended base units.	39 / 40,5	59
		per basi fino a terra con zoccolo H.8 cm for base units to the floor with plinth H. 8 cm	86 / 89	59
		per basi fino a terra con zoccolo H.8 cm for base units to the floor with plinth H. 8 cm	86 / 89	72

ARTICOLO ARTICLE	DESCRIZIONE Description	H.(cm) H.(cm)	PROF. (cm) DEPTH (cm)		
	FIANCO PER PENSILI SIDE PANEL FOR WALL UNITS		36	34	
			48	34	
			60	34	
			72	34	
			96	34	
			108	34	
			132	34	
			per pensile copriboiler for boiler housing wall unit	72	45
			per pensile copriboiler for boiler housing wall unit	96	45
			per pensile sopra colonne for wall unit over tall units	36	59
			per pensile sopra colonne for wall unit over tall units	48	59

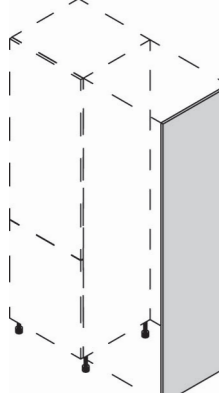
ARTICOLO ARTICLE	DESCRIZIONE Description	H.(cm) H.(cm)	PROF. (cm) DEPTH (cm)		
	FIANCO PER COLONNE SIDE PANEL FOR TALL UNITS		138 / 141	59	
			210	34	
			210	59	
			234	59	
			per colonna sospese for suspended tall unit	129 / 132	59
			per colonna sospese for suspended tall unit	153 / 156	59

TERMO STRUTTURATO THERMO TEXTURED	PET PET	LAMINATO MATERICO TEXTURED LAMINATE	FENIX FENIX
9	20	27	39
19	35	33	72
23	41	38	87
4	8	12	14
4	11	12	19
7	14	18	21
6	14	18	26
9	19	19	35
20	39	42	76
25	46	49	93

8	13	18	19
11	16	23	26
13	19	27	31
14	23	31	38
15	29	36	50
18	29	44	54
20	38	45	69
11	28	35	49
17	29	44	62
10	17	18	34
16	23	24	42

36	62	55	122
33	59	67	110
54	92	107	186
63	105	115	210
36	60	57	118
39	70	61	138

FIANCHI A RIPORTO

FIANCHI MONTATI IN ACCOSTAMENTO ALLA SCOCCA DEL MOBILE, FANNO SPESSORE
SIDE PANELS MOUNTED AGAINST THE UNIT CARCASS, INCREASE IN THICKNESS

END PANELS

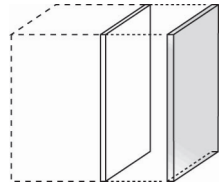
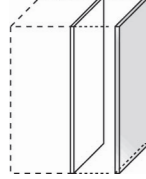
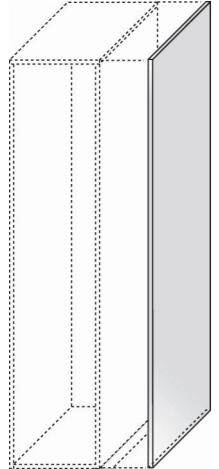
ARTICOLO ARTICLE	DESCRIZIONE Description	H.(cm) H.(cm)	PROF. (cm) DEPTH (cm)	CODICE CODE		
	FIANCO PER BASI SIDE PANEL FOR BASE UNITS	78 / 81	36,5	P05V.01		
		78 / 81	61,5	P05V.01		
		78 / 81	74,5	P05V.01		
		19,5 / 21,75	49,5	P05V.01		
		19,5 / 21,75	61,5	P05V.01		
		78 / 81	49,5	P05V.01		
		per basi fino a terra con zoccolo H.8 cm for base units to the floor with plinth H. 8 cm	86 / 89	61,5	P05V.01	
		per basi fino a terra con zoccolo H.8 cm for base units to the floor with plinth H. 8 cm	86 / 89	74,5	P05V.01	
			FIANCO PER PENSILI SIDE PANEL FOR WALL UNITS	36	36,5	P05V.01
				48	36,5	P05V.01
60	36,5			P05V.01		
72	36,5			P05V.01		
96	36,5			P05V.01		
108	36,5			P05V.01		
132	36,5			P05V.01		
(per cappa dep. estraibile) (for pull-out extractor unit)	66/72			36,5	P05V.01	
(per cappa dep. estraibile) (for pull-out extractor unit)	90/96			36,5	P05V.01	
	FIANCO PER COLONNE SIDE PANEL FOR TALL UNITS			138 / 141	61,5	P05V.01
		210	36,5	P05V.01		
		210	61,5	P05V.01		
		234	36,5	P05V.01		
		234	61,5	P05V.01		
		per colonna sospese for suspended tall unit	129 / 132	61,5	P05V.01	
		per colonna sospese for suspended tall unit	153 / 156	61,5	P05V.01	
		per strutture con ante fino a terra for structures with doors up to the ground	218	61,5	P05V.01	
		per strutture con ante fino a terra for structures with doors up to the ground	242	61,5	P05V.01	

NEW
NEW

TERMO STRUTTURATO sp. 1,4 cm THERMO TEXTURED Th. 1,4 cm	LAMINATO MATERICO sp. 1,4 cm TEXTURED LAMINATE Th. 1,4 cm
141,98	41,98
70,74	70,74
85,69	85,69
28,40	28,40
28,40	28,40
56,93	56,93
77,72	77,72
94,15	91,15
28,40	28,40
28,40	28,40
31,10	31,10
37,32	37,32
49,76	49,76
55,98	55,98
68,42	68,42
37,32	37,32
49,76	49,76
123,13	123,14
108,84	108,84
183,39	183,39
121,28	121,28
204,35	204,35
115,28	115,28
136,23	136,23
190,38	190,38
211,34	211,34

FIANCHI A RIPORTO

FIANCHI MONTATI IN ACCOSTAMENTO ALLA SCOCCA DEL MOBILE, FANNO SPESSORE
SIDE PANELS MOUNTED AGAINST THE UNIT CARCASS, INCREASE IN THICKNESS

END PANELS

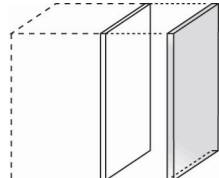
ARTICOLO ARTICLE	DESCRIZIONE Description	H.(cm) H.(cm)	PROF. (cm) DEPTH (cm)	CODICE CODE	
	FIANCO PER BASI SIDE PANEL FOR BASE UNITS	78 / 81	34	N813.00	
		78 / 81	59	N815.00	
		78 / 81	72	N817.00	
		19,5 / 21,75	47	N024.00	
		19,5 / 21,75	59	N025.00	
		39 / 40,5	34	N403.00	
		39 / 40,5	47	N404.00	
		39 / 40,5	59	N405.00	
		per basi fino a terra con zoccolo H.8 cm for base units to the floor with plinth H. 8 cm	86 / 89	59	N885.00
		per basi fino a terra con zoccolo H.8 cm for base units to the floor with plinth H. 8 cm	86 / 89	72	N887.00

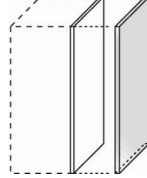
	FIANCO PER PENSILI SIDE PANEL FOR WALL UNITS	36	34	N363.00	
		48	34	N483.00	
		60	34	N603.00	
		72	34	N723.00	
		96	34	N963.00	
		108	34	N103.00	
		132	34	N133.00	
		(per cappa dep. estraibile) (for pull-out extractor unit)	66/72	34	N723.00
		(per cappa dep. estraibile) (for pull-out extractor unit)	90/96	34	N963.00

	FIANCO PER COLONNE SIDE PANEL FOR TALL UNITS	138 / 141	59	N135.01	
		210	34	N213.00	
		210	59	N215.00	
		234	59	N235.00	
		per colonna sospese for suspended tall unit	129 / 132	59	N135.00
		per colonna sospese for suspended tall unit	153 / 156	59	N155.00

TERMO STRUTTURATO sp. 1,8 cm THERMO TEXTURED Th. 1,8 cm	PET sp. 1,8 cm PET Th. 1,8 cm	LAMINATO MATERICO sp. 1,8 cm TEXTURED LAMINATE Th. 1,8 cm	FENIX sp. 1,8 cm FENIX Th. 1,8 cm
24	35	42	54
39	55	53	92
47	65	62	111
13	17	21	23
13	20	21	28
14	21	25	28
18	26	30	38
21	31	31	47
42	61	64	98
51	72	75	119
14	19	24	25
18	23	30	33
22	28	36	40
24	33	41	48
28	42	49	63
36	47	62	72
38	56	63	87
24	33	41	48
28	42	49	63
64	90	83	150
59	85	93	136
95	133	148	227
105	147	157	252
62	86	83	144
70	101	92	169

MENSOLE

SHELVES

TIPOLOGIA MATERIALE TYPE OF MATERIAL	COLORI COLOURS	DISPONIBILE NEI MODELLI AVAILABLE IN MODELS
NOBILITATO colore scocca MELAMINE carcass colour	ROSE VULCAN WHITE	UNIVERSALE UNIVERSAL
IMPIALLACCIATO VENEERED	ROVERE COGNAC ROVERE SAHARA ROVERE GREY ROVERE MIELE ROVERE DARK ROVERE BIANCO ROVERE CHERRY ROVERE NERO	NATURAL
LAMINATO MATERICO TEXTURED LAMINATE	CALCE CEMENTO CEMENTO BIANCO NERO MARQUINIA CEMENTO VISIONE CEMENTO DARK PIASENTINA SCURA GRAFITE BROWN	METROPOLIS METROPOLIS

MENSOLE

SHELVES

TIPOLOGIA MATERIALE TYPE OF MATERIAL	COLORI COLOURS	DISPONIBILE NEI MODELLI AVAILABLE IN MODELS
PET PET	BIANCO ASSOLUTO LUCIDO BIANCO ASSOLUTO OPACO CACHEMERE LUCIDO CACHEMERE OPACO GRIGIO FUMO OPACO NEBBIA OPACO GRIGIO FREDDO OPACO GRAU OPACO NERO OPACO CAFFÈ OPACO CANNA DI FUCILE OPACO GINSENG OPACO BEIGE SETA OPACO	METROPOLIS
TERMO STRUTTURATO THERMO STRUCTURED	LARICE BROWN LARICE SABBIA NOCE EUCALIPTO ROVERE SOLE ROVERE NODATO ROVERE NATURA	METROPOLIS
FENIX FENIX	GRIGIO LONDRA GRIGIO EFESO NERO INGO GRIGIO BROMO BIANCO KOS BEIGE ARIZONA GRIGIO ANTRIM ROSSO JAIPUR VERDE COMODORO CASTORO OTTAWA CACAO ORINOCO BLU FES	METROPOLIS



MENSOLE

SHELVES

ARTICOLO ARTICLE	DESCRIZIONE DESCRIPTION	SP.(cm) TH.(cm)	PROF. (cm) DEPTH (cm)	CODICE CODE
	MENSOLA BORDO DRITTO Lunghezza al ml STRAIGHT EDGE SHELF Length per lm	3	34	MV3B000
		3	49,5	MV49000
		3	61,5	MV61000

LAVORAZIONI PER MENSOLE

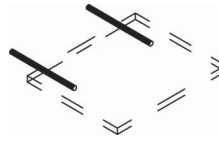
PROCESSING FOR SHELVES

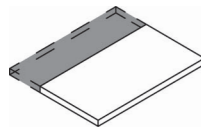
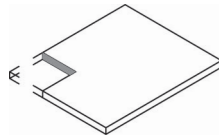
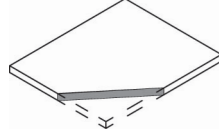
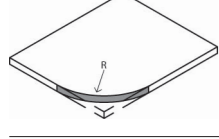
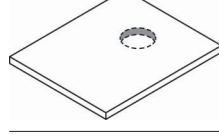
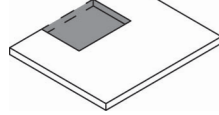
LAVORAZIONE PROCESSING	MAGGIORAZIONE INCREASE	PTS.
	SUPPORTO MENSOLE A SCOMPARSA, Cad. 1 (il N° di supporti è determinato dalla lunghezza della mensola) SUPPORT SHELF TO DISAPPEARANCE, Each (the N° of supports is determined by the length of the shelf)	+ 6
	PIEDINI SU MENSOLE USO FIANCO (questa maggiorazione prevede l'inserimento di piedini) FOOTSIES ON SHELF USE SIDE (this increase foresees the insertion of footsies)	+ 4
	RIDUZIONE IN PROFONDITÀ (MAGT001) DEPTH REDUCTION (MAGT001)	+ 35
	SCANSO PILASTRO FRONTE O RETRO (MAGT001) FRONTAL OR BACK CUT FOR PILLAR (MAGT001)	+ 35
	TAGLIO INCLINATO O FUORI SQUADRA (MAGT001) INCLINED CUT OR OUT OF SQUARE (MAGT001)	+ 35
	TERMINALE CURVO (RAGGIO MINIMO 30 mm) (MAGT005) CURVED END (R. MIN. 30 mm) (MAGT005)	+ 35
	FORO FARETTO (000FM00000) HOLE LIGHT (000FM00000)	+ 6
	FORO CAPPÀ (MAGF000) HOLE HOOD (MAGF000)	+ 30

NOBILITATO colore scocca MELAMINE carcass colour	TERMO STRUTTURATO THERMO TEXTURED	PET PET	LAMINATO MATERICO TEXTURED LAMINATE	FENIX FENIX
43	105	108	100	179
56	111	179	104	181
70	121	182	108	184

	NOBILITATO colore scocca MELAMINE carcass colour	TERMO ESTRUTTURATO THERMO STRUCTURE	PET PET	LAMINATO MATERICO TEXTURED LAMINATE	FENIX FENIX
L. max (cm)	275	273	265	265	300

PANNELLI

PANELS

TIPOLOGIA MATERIALE TYPE OF MATERIAL	COLORI COLOURS	DISPONIBILE NEI MODELLI AVAILABLE IN MODELS
NOBILITATO colore scocca MELAMINE carcass colour	ROSE VULCAN WHITE	UNIVERSALE UNIVERSAL
BIFACCIALE DOUBLE - FACE		
IMPIALLACCIATO VENEERED	ROVERE COGNAC ROVERE SAHARA ROVERE GREY ROVERE MIELE ROVERE DARK ROVERE BIANCO ROVERE CHERRY ROVERE NERO	NATURAL
BIFACCIALE DOUBLE - FACE		
LAMINATO MATERICO TEXTURED LAMINATE	CALCE CEMENTO CEMENTO BIANCO NERO MARQUINIA CEMENTO VISIONE CEMENTO DARK PIASENTINA SCURA GRAFITE BROWN	METROPOLIS METROPOLIS





PANNELLI

PANELS

TIPOLOGIA MATERIALE TYPE OF MATERIAL	COLORI COLOURS	DISPONIBILE NEI MODELLI AVAILABLE IN MODELS
PET PET	BIANCO ASSOLUTO LUCIDO BIANCO ASSOLUTO OPACO CACHEMERE LUCIDO CACHEMERE OPACO GRIGIO FUMO OPACO NEBBIA OPACO GRIGIO FREDDO OPACO GRAU OPACO NERO OPACO CAFFÈ OPACO CANNA DI FUCILE OPACO GINSENG OPACO BEIGE SETA OPACO	METROPOLIS
BIFACCIALE DOUBLE - FACE		
TERMO STRUTTURATO THERMO STRUCTURED	LARICE BROWN LARICE SABBIA NOCE EUCALIPTO ROVERE SOLE ROVERE NODATO ROVERE NATURA	METROPOLIS
BIFACCIALE DOUBLE - FACE		
FENIX FENIX	GRIGIO LONDRA GRIGIO EFESO NERO INGO GRIGIO BROMO BIANCO KOS BEIGE ARIZONA GRIGIO ANTRIM ROSSO JAIPUR VERDE COMODORO CASTORO OTTAWA CACAO ORINOCO BLU FES	METROPOLIS
BIFACCIALE DOUBLE - FACE		

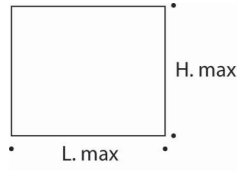

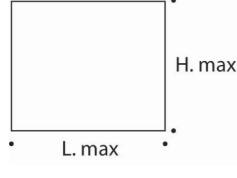
PANNELLI

PANELS

ARTICOLO ARTICLE	DESCRIZIONE Description	SP.(cm) TH.(cm)	DIMENSIONI DIMENSIONS	CODICE CODE
	PANNELLO MONOFACCIALE INTERNO ROSÈ O VULCAN O WHITE (Faccia esterna e bordi in tutti i colori delle ante; Faccia interna Rosè o Vulcan o White come scocca) ROSÈ OR VULCAN OR WHITE INTERNAL SINGLE-FACE PANEL (Exterior and edges available with all door finishes; Rosè or Vulcan or White internal face same as carcass)	1,8	mq	P03V.00
				
	PANNELLO BIFACCIALE (Faccia esterna, Faccia interna e bordi in tutti i colori delle ante) DOUBLE-FACE PANEL (Outside, inside and edges available with all door colours)	1,4 1,8	mq mq	P05V.01 P03V.01
				

LAVORAZIONI PER PANNELLI

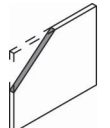
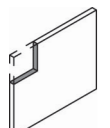
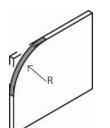
MACHINING FOR PANELS

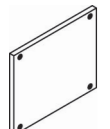
LAVORAZIONE MACHINING	MAGGIORAZIONE SURCHARGE	PTS.
	TAGLIO INCLINATO (MAGA050) INCLINED CUT (MAGA050)	+ 32
	SCASSO SU PANNELLO (MAGA050) PANEL CUT-OUT (MAGA050)	+ 32
	TAGLIO CURVO (RAGGIO MINIMO 30 mm) (MAGA050) CURVED CUT (MIN. RADIUS 30 mm) (MAGA050)	+ 32
	PIEDINI REGOLABILI (MAGA165) SOCKET HOLE (MAGA165)	+ 4
	FIT LOCK (MAGA156) FIT LOCK (MAGA156)	+ 39



SP. 1,4 CM: Minimo fatturabile per dimensioni inferiori a 0,20 MQ per tutti i laccati; Minimo fatturabile per dimensioni inferiori a 0,30 MQ per impiallacciati
SP. 1,4 CM: Minimum invoice for dimensions smaller than 0,20 MQ for all lacquered; Minimum invoice for dimensions less than 0.30 square meters for veneered

SP. 1,8 CM: Minimo fatturabile per dimensioni inferiori a 0,25 MQ per tutte le finiture
SP. 1.8 CM: Minimum invoice for dimensions smaller than 0.25 MQ for all finishes

NOBILITATO colore scocca MELAMINE carcass colour	TERMO STRUTTURATO THERMO TEXTURED	PET PET	LAMINATO MATERICO TEXTURED LAMINATE	FENIX FENIX
-	-	-	-	-
-	142	-	142	-
39	62	99	63	231

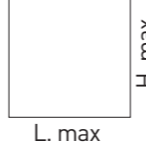
	NOBILITATO colore scocca MELAMINE carcass colour	TERMO STRUTTURATO THERMO TEXTURED	PET PET	LAMINATO MATERICO TEXTURED LAMINATE	FENIX FENIX
					
L. max (cm)	280	170	110	120	120
H. max (cm)	175	270	270	275	300
venatura pannelli panels grain pattern	NO VENATURA NO GRAIN PATTERN	verticale vertical	NO VENATURA NO GRAIN PATTERN	verticale vertical	NO VENATURA NO GRAIN PATTERN
H L					

Dimensioni riferire alla massima Altezza e Larghezza dei pannelli

Dimensions refer to the maximum height and width of the panels

CAPPE ESTETICHE

AESTHETIC HOODS

STRUTTURA STRUCTURE	DESCRIZIONE DESCRIZIONE	TIPOLOGIA MATERIALE TYPE OF MATERIAL	COLORI COLOURS
	1 Corpo aspirante Suction body	ACCIAIO STEEL	 ANTRACITE
	2 Pannello in legno Wooden panel	IMPIALLACCIATO con Doghe VENEERED with Slats	
		IMPIALLACCIATO Liscio VENEERED Smooth	
		FENIX FENIX 	
		LAMINATO MATERICO TEXTURED LAMINATE	
		TERMO STRUTTURATO THERMO STRUCTURED	



Si consiglia di non inserire pensili adiacenti al pannello legno in Fenix in quanto risulterebbe un disallineamento dovuto da profondità diverse
It is advisable not to insert wall units adjacent to the Fenix wood panel as it would result in a misalignment due to different depths

CAPPE ESTETICHE

AESTHETIC HOODS

STRUTTURA STRUCTURE	DESCRIZIONE DESCRIZIONE	TIPOLOGIA MATERIALE TYPE OF MATERIAL	COLORI COLOURS
	3 Pannello decor Decor panel	HPL HPL	
	4 Camino Fireplace	FENIX FENIX	
		LAMINATO MATERICO TEXTURED LAMINATE	
		ACCIAIO STEEL	 ANTRACITE

COME SI COMPONE IL PREZZO :

Il prezzo si compone scegliendo la tipologia di cappa (esempio tipo 1). Sommare i prezzi del corpo aspirante + prezzi del pannello in legno + prezzo del pannello decor + prezzi del camino.

HOW TO DO THE PRICE:

The price is made by choosing the type of hood (example type 1). Add up the prices of the suction body + prices of the wood panel + price of the decor panel + prices of the fireplace.

CAPPE ESTETICHE

AESTHETIC HOODS

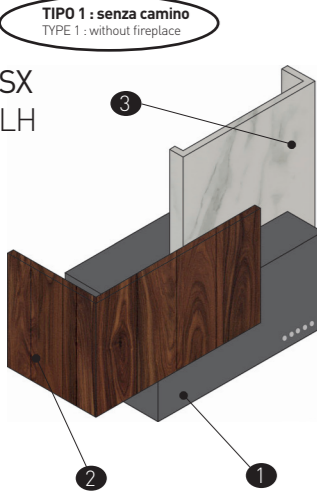
CAPPA HOOD	DESCRIZIONE DESCRIPTION	DIMENSIONI (cm) DIMENSIONS (cm)	CODICE CODE
TIPO 1 : senza camino TYPE 1 : without fireplace SX LH 	CORPO ASPIRANTE FUSION, 1 motore portata max 650 mc/h 2 faretti led 1,2 W 4000 °K 2 filtri alluminio FUSION SUCTION BODY, 1 motor max air flow rate 650 m3/h 2 spotlights led 1,2 W 4000 ° K 2 aluminum filters	1 H.30xPr.35,2xL.60	100DC60F01
	PANNELLO LEGNO WOODEN PANEL	2 H.35,7xPr.36,45xL.59,7	DB60000
	PANNELLO DECOR DECOR PANEL	3 H.59,7 x Pr.10 x L.48	DB48000

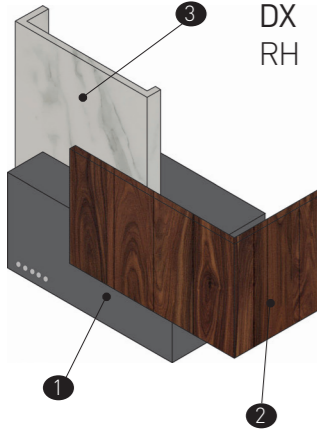
TIPO 1 : senza camino TYPE 1 : without fireplace DX RH 	CORPO ASPIRANTE FUSION, 1 motore portata max 650 mc/h 2 faretti led 1,2 W 4000 °K 2 filtri alluminio FUSION SUCTION BODY, 1 motor max air flow rate 650 m3/h 2 spotlights led 1,2 W 4000 ° K 2 aluminum filters	1 H.30xPr.35,2xL.60	100DC60F01
	PANNELLO LEGNO WOODEN PANEL	2 H.35,7xPr.36,45xL.59,7	DB60000
	PANNELLO DECOR DECOR PANEL	3 H.59,7 x Pr.10 x L.48	DB48000

ACCIAIO STEEL	IMPIALLACCIATO VENEERED	HPL HPL	FENIX FENIX	TERMO STRUTTURATO THERMO TEXTURED	LAMINATO MATERICO TEXTURED LAMINATE
574	-	-	-	-	-

-	266	-	277	157	157
---	-----	---	-----	-----	-----

-	-	304	243	122	122
---	---	-----	-----	-----	-----

574	-	-	-	-	-
-----	---	---	---	---	---

-	266	-	277	157	157
---	-----	---	-----	-----	-----

-	-	304	243	122	122
---	---	-----	-----	-----	-----

CAPPE ESTETICHE

AESTHETIC HOODS

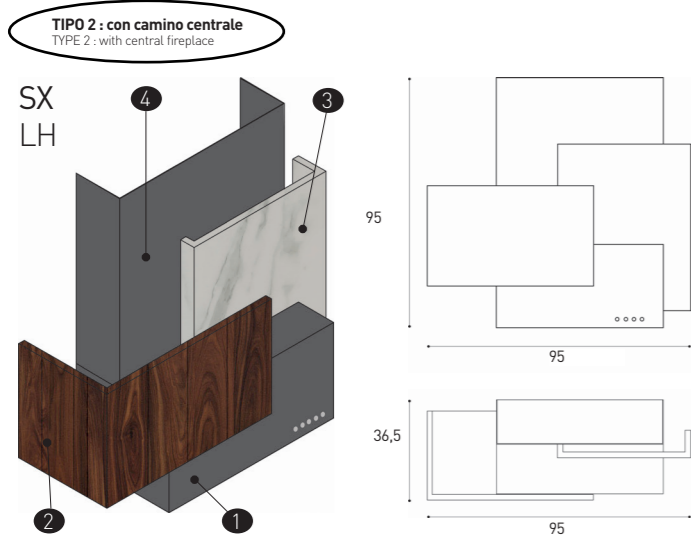
CAPPA HOOD	DESCRIZIONE DESCRIPTION	DIMENSIONI (cm) DIMENSIONS (cm)	CODICE CODE
 <p>TIPO 2 : con camino centrale TYPE 2 : with central fireplace</p> <p>SX LH</p>	CORPO ASPIRANTE FUSION, 1 motore portata max 650 mc/h 2 faretti led 1,2 W 4000 °K 2 filtri alluminio FUSION SUCTION BODY, 1 motor max air flow rate 650 m3/h 2 spotlights led 1,2 W 4000 ° K 2 aluminum filters	① H.30xPr.35,2xL.60	100DC60F01
	PANNELLO LEGNO WOODEN PANEL	② H.35,7xPr.36,45xL.59,7	DB60000
	PANNELLO DECOR DECOR PANEL	③ H.59,7 x Pr.10 x L.48	DB48000
	CAMINO FIREPLACE	④ H.65 x Pr.18 x L.60	200U660TB1

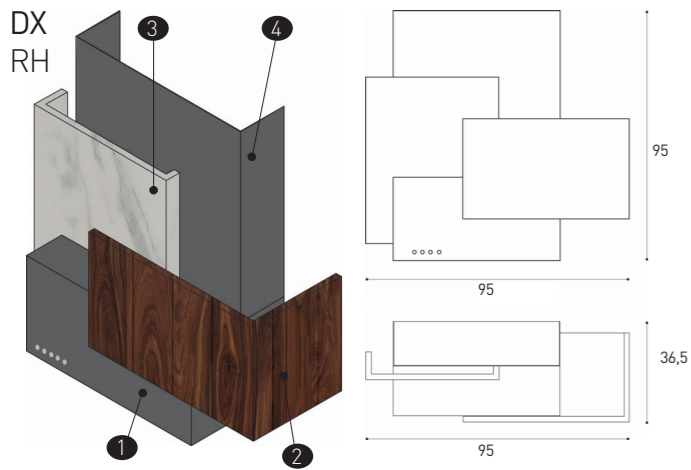
 <p>TIPO 2 : con camino centrale TYPE 2 : with central fireplace</p> <p>DX RH</p>	CORPO ASPIRANTE FUSION, 1 motore portata max 650 mc/h 2 faretti led 1,2 W 4000 °K 2 filtri alluminio FUSION SUCTION BODY, 1 motor max air flow rate 650 m3/h 2 spotlights led 1,2 W 4000 ° K 2 aluminum filters	① H.30xPr.35,2xL.60	100DC60F01
	PANNELLO LEGNO WOODEN PANEL	② H.35,7xPr.36,45xL.59,7	DB60000
	PANNELLO DECOR DECOR PANEL	③ H.59,7 x Pr.10 x L.48	DB48000
	CAMINO FIREPLACE	④ H.65 x Pr.18 x L.60	200U660TB1

ACCIAIO STEEL	IMPIALLACCIATO VENEERED	HPL HPL	FENIX FENIX	TERMO STRUTTURATO THERMO TEXTURED	LAMINATO MATERICO TEXTURED LAMINATE
574	-	-	-	-	-
-	266	-	277	157	157
-	-	304	243	122	122
120	-	-	-	-	-
574	-	-	-	-	-
-	266	-	277	157	157
-	-	304	243	122	122
120	-	-	-	-	-

CAPPE ESTETICHE

AESTHETIC HOODS

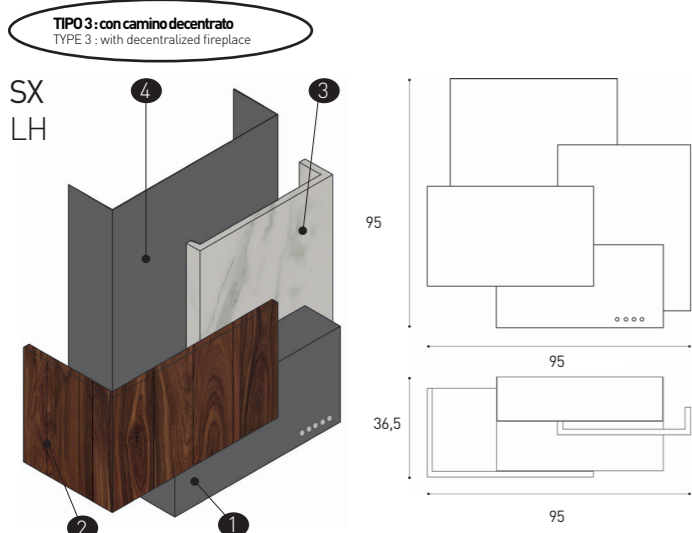
CAPPA HOOD	DESCRIZIONE DESCRIPTION	DIMENSIONI (cm) DIMENSIONS (cm)	CODICE CODE
 <p>TIPO 3: con camino decentrato TYPE 3: with decentralized fireplace</p> <p>SX LH</p>	CORPO ASPIRANTE FUSION, 1 motore portata max 650 mc/h 2 faretti led 1,2 W 4000 °K 2 filtri alluminio FUSION SUCTION BODY, 1 motor max air flow rate 650 m3/h 2 spotlights led 1,2 W 4000 °K 2 aluminum filters	1 H.30xPr.35,2xL.60	100DC60F01
	PANNELLO LEGNO WOODEN PANEL	2 H.35,7xPr.36,45xL.59,7	DB60000
	PANNELLO DECOR DECOR PANEL	3 H.59,7 x Pr.10 x L.48	DB48000
	CAMINO FIREPLACE	4 H.65 x Pr.18 x L.60	200U660TB1

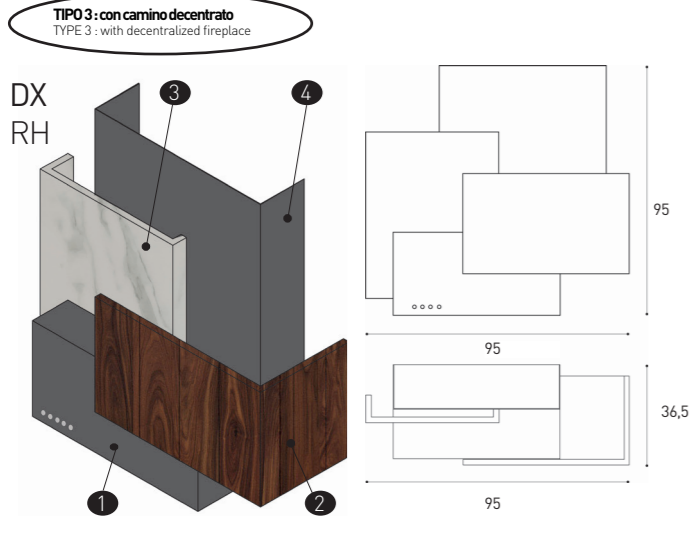
 <p>TIPO 3: con camino decentrato TYPE 3: with decentralized fireplace</p> <p>DX RH</p>	CORPO ASPIRANTE FUSION, 1 motore portata max 650 mc/h 2 faretti led 1,2 W 4000 °K 2 filtri alluminio FUSION SUCTION BODY, 1 motor max air flow rate 650 m3/h 2 spotlights led 1,2 W 4000 °K 2 aluminum filters	1 H.30xPr.35,2xL.60	100DC60F01
	PANNELLO LEGNO WOODEN PANEL	2 H.35,7xPr.36,45xL.59,7	DB60000
	PANNELLO DECOR DECOR PANEL	3 H.59,7 x Pr.10 x L.48	DB48000
	CAMINO FIREPLACE	4 H.65 x Pr.18 x L.60	200U660TB1

ACCIAIO STEEL	IMPIALLACCIATO VENEERED	HPL HPL	FENIX FENIX	TERMO STRUTTURATO THERMO TEXTURED	LAMINATO MATERICO TEXTURED LAMINATE
574	-	-	-	-	-
-	266	-	277	157	157
-	-	304	243	122	122
120	-	-	-	-	-
574	-	-	-	-	-
-	266	-	277	157	157
-	-	304	243	122	122
120	-	-	-	-	-

CAPPE ESTETICHE

AESTHETIC HOODS

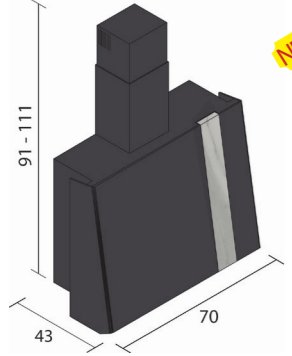
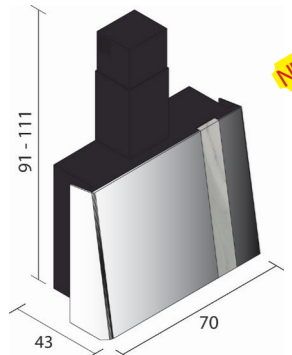
STRUTTURA STRUCTURE	DESCRIZIONE DESCRIPTION	L.(cm) W.(cm)	CODICE CODE	PTS.
	CAPPA DIVIDE A PARETE , metallo colore Nero Opaco 1 motore portata max. 650 m ³ /h Carter apribile colore Nero Opaco + Inserto DIVIDE WALL-MOUNTED HOOD, steel Matt Black color 1 motor max. capacity 650 m ³ /h Matt Black openable cover + Insert	70	DR70000	1191
	CAPPA DIVIDE A PARETE , metallo colore Nero Opaco 1 motore portata max. 650 m ³ /h Carter apribile colore Titanio + Inserto DIVIDE WALL-MOUNTED HOOD, steel Matt Black color 1 motor max. capacity 650 m ³ /h Titanium openable cover + Insert	70	DR70000	1287



Inserto disponibile nelle seguenti finiture:
Insert available in the following finishes:

TERMOSTRUTTURATO
THERMO STRUCTURED

LARICE BROWN LARICE SABBIA NOCE EUCALIPTO ROVERE SOLE ROVERE NODATO ROVERE NATURA

LAMINATO MATERICO
TEXTURED LAMINATE

CALCE CEMENTO CEMENTO BIANCO NERO MARQUINIA CEMENTO VISONE GRAFITE BROWN CEMENTO DARK PIASENTINA SCURA

CAPPE ESTETICHE

AESTHETIC HOODS

STRUTTURA STRUCTURE	DESCRIZIONE DESCRIPTION	L.(cm) W.(cm)	CODICE CODE	PTS.
	CAPPA BOW A PARETE , metallo colore Nero Opaco 1 motore portata max. 650 m ³ /h Carter apribile colore Nero Opaco BOW WALL-MOUNTED HOOD, steel Matt Black color 1 motor max. capacity 650 m ³ /h Matt Black openable cover	70	100D070B00	1154
	CAPPA BOW A PARETE , metallo colore Nero Opaco 1 motore portata max. 650 m ³ /h Carter apribile colore Titanio BOW WALL-MOUNTED HOOD, steel Matt Black color 1 motor max. capacity 650 m ³ /h Titanium openable cover	70	100D070B01	1250
	CAPPA LIFT A PARETE , metallo colore Nero Opaco 1 motore portata max. 650 m ³ /h Carter apribile colore Nero Opaco LIFT WALL-MOUNTED HOOD, steel Matt Black color 1 motor max. capacity 650 m ³ /h Matt Black openable cover	70	100D070L01	1129
	CAPPA LIFT A PARETE , metallo colore Nero Opaco 1 motore portata max. 650 m ³ /h Carter apribile colore Titanio LIFT WALL-MOUNTED HOOD, steel Matt Black color 1 motor max. capacity 650 m ³ /h Titanium openable cover	70	100D070L02	1225
	CAPPA TIDE ISOLA , metallo + vetro Nero Satinato 1 motore portata max. 650 m ³ /h TIDE ISLAND HOOD, metal + Black Satin glass 1 motor max. 650 m ³ /h	60 x 90	100DI90T05	2532

ELEMENTI A GIORNO

OPEN ELEMENTS

TIPOLOGIA MATERIALE TYPE OF MATERIAL	COLORI COLOURS	DISPONIBILE NEI MODELLI AVAILABLE IN MODELS
NOBILITATO colore scocca MELAMINE carcass colour	ROSÉ VULCAN WHITE	UNIVERSALE UNIVERSAL
LAMINATO MATERICO TEXTURED LAMINATE	CALCE CEMENTO CEMENTO BIANCO NERO MARQUINIA CEMENTO VIGONE CEMENTO DARK PIASENTINA SCURA GRAFITE BROWN	METROPOLIS METROPOLIS
PET PET	BIANCO ASSOLUTO LUCIDO BIANCO ASSOLUTO OPACO CACHEMERE LUCIDO CACHEMERE OPACO GRIGIO FUMO OPACO NEBBIA OPACO GRIGIO FREDDO OPACO GRAU OPACO NERO OPACO CAFFÈ OPACO CANNA DI FUCILE OPACO GINSENG OPACO BEIGE SETA OPACO	METROPOLIS



ELEMENTI A GIORNO

OPEN ELEMENTS

TIPOLOGIA MATERIALE TYPE OF MATERIAL	COLORI COLOURS	DISPONIBILE NEI MODELLI AVAILABLE IN MODELS
TERMO STRUTTURATO THERMO STRUCTURED	LARICE BROWN LARICE SABBIA NOCE EUCALIPTO ROVERE SOLE ROVERE NODATO ROVERE NATURA	METROPOLIS
FENIX FENIX	GRIGIO LONDRA GRIGIO EFESO NERO INGO GRIGIO BROMO BIANCO KOS BEIGE ARIZONA GRIGIO ANTRIM ROSSO JAIPUR VERDE COMODORO CASTORO OTTAWA CACAO ORINOCO BLUFES	METROPOLIS

ELEMENTI A GIORNO, per basi

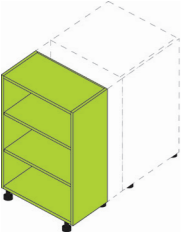
OPEN ELEMENTS, for base units

ARTICOLO ARTICLE	DESCRIZIONE DESCRIPTION	H.(cm) H.(cm)	PROF. (cm) DEPTH (cm)	LARGH. (cm) WIDTH (cm)	CODICE CODE
	BASE JOLLY, 1 ripiano BASE UNIT JOLLY, 1 shelf	78/81	36,4	da 10 a 45	BM45H00
		78/81	36,4	da 45,1 a 60	BM45H00
	BASE TERMINALE LATERALE A GIORNO, 2 ripiani SIDE OPEN END BASE UNIT, 2 shelves	78/81	30	61,4	BM61H02
	BASE TERMINALE LATERALE A GIORNO, 2 ripiani SIDE OPEN END BASE UNIT, 2 shelves	78/81	15	61,4	BM61H01

ELEMENTI A GIORNO, per pensili

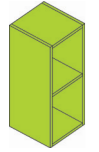
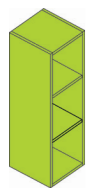
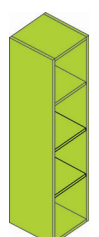

OPEN ELEMENTS, for wall units

ARTICOLO ARTICLE	DESCRIZIONE DESCRIPTION	H.(cm) H.(cm)	PROF. (cm) DEPTH (cm)	LARGH. (cm) WIDTH (cm)	CODICE CODE
	PENSILE JOLLY JOLLY WALL UNIT	36	36,4	da 13 a 45	PA45B00
		36	36,4	da 45,1 a 60	PA45B00
	PENSILE JOLLY, 1 ripiano JOLLY WALL UNIT, 1 shelf	48	36,4	da 13 a 45	PA45D00
		48	36,4	da 45,1 a 60	PA45D00
		60	36,4	da 13 a 45	PA45F00
		60	36,4	da 45,1 a 60	PA45F00
		72	36,4	da 13 a 45	PA45H00
		72	36,4	da 45,1 a 60	PA45H00
	PENSILE JOLLY, 2 ripiani WALL UNIT JOLLY, 2 shelves	96	36,4	da 13 a 45	PA45J00
		96	36,4	da 45,1 a 60	PA45J00
	PENSILE JOLLY, 3 ripiani WALL UNIT JOLLY, 3 shelves	108	36,4	da 13 a 45	PA45L00
		108	36,4	da 45,1 a 60	PA45L00
		132	36,4	da 13 a 45	PA45N00
		132	36,4	da 45,1 a 60	PA45N00

NOBILITATO colore scocca SP. 1,8 MELAMINE carcass colour TH. 1,8	PET SP. 1,8 PET Ep. 1,8	FENIX SP. 1,8 FENIX Ep. 1,8	TERMO STRUTTURATO SP. 1,8 THERMO TEXTURED TH. 1,8	LAMINATO MATERICO SP. 1,8 TEXTURED LAMINATE TH. 1,8
145	383	429	196	277
189	498	558	255	360
157	373	418	185	256
135	269	303	163	185
85	199	223	114	143
111	259	290	149	186
105	219	246	132	159
137	285	321	172	207
105	229	258	139	165
137	299	335	181	216
114	277	311	151	199
149	360	405	196	259
129	349	391	187	252
168	454	509	244	329
159	376	423	185	272
207	490	550	241	354
169	471	528	231	340
220	613	686	301	441

ELEMENTI A GIORNO, per colonne

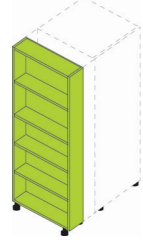
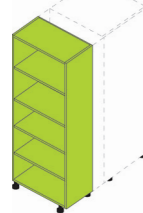
OPEN ELEMENTS, for tall units

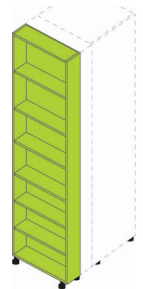
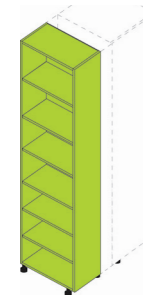
ARTICOLO ARTICLE	DESCRIZIONE DESCRIPTION	H.(cm) H.(cm)	PROF. (cm) DEPTH (cm)	LARGH. (cm) WIDTH (cm)	CODICE CODE
	COLONNA JOLLY, 4 ripiani TALL UNIT JOLLY, 4 shelves	138	36,4	da 10 a 45	CB45N00
		138	36,4	da 45,1 a 60	CB45N00
	COLONNA TERMINALE LATERALE A GIORNO, 4 ripiani SIDE OPEN END TALL UNIT, 4 shelves	138	15	61,4	CB61N01
	COLONNA TERMINALE LATERALE A GIORNO, 4 ripiani SIDE OPEN END TALL UNIT, 4 shelves	138	30	61,4	CB61N02
	COLONNA JOLLY, 6 ripiani TALL UNIT JOLLY, 6 shelves	210	36,4	da 10 a 45	CB45P00
		210	36,4	da 45,1 a 60	CB45P00
	COLONNA TERMINALE LATERALE A GIORNO, 6 ripiani SIDE OPEN END TALL UNIT, 6 shelves	210	15	61,4	CB61P01
	COLONNA TERMINALE LATERALE A GIORNO, 6 ripiani SIDE OPEN END TALL UNIT, 6 shelves	210	30	61,4	CB61P02

NOBILITATO colore scocca SP. 1,8 MELAMINE carcass colour TH. 1,8	PET SP. 1,8 PET Ép. 1,8	FENIX SP. 1,8 FENIX Ép. 1,8	TERMO STRUTTURATO SP. 1,8 THERMO TEXTURED TH. 1,8	LAMINATO MATERICO SP. 1,8 TEXTURED LAMINATE TH. 1,8
199	635	712	303	459
259	826	927	394	598
167	418	470	234	335
206	574	644	296	459
279	888	996	437	640
363	1154	1295	569	832
215	649	728	344	470
272	880	989	423	637

ELEMENTI A GIORNO, per colonne

OPEN ELEMENTS, for tall units

ARTICOLO ARTICLE	DESCRIZIONE DESCRIPTION	H.(cm) H.(cm)	PROF. (cm) DEPTH (cm)	LARGH. (cm) WIDTH (cm)	CODICE CODE
---------------------	----------------------------	------------------	--------------------------	---------------------------	----------------



COLONNA JOLLY,
7 ripiani
TALL UNIT JOLLY,
7 shelves

234	36,4	da 10 a 45	CB45T00
234	36,4	da 45,1 a 60	CB45T00

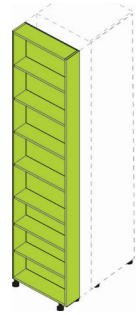

COLONNA TERMINALE LATERALE A GIORNO,
7 ripiani
SIDE OPEN END TALL UNIT,
7 shelves

234	15	61,4	CB61T01
-----	----	------	---------

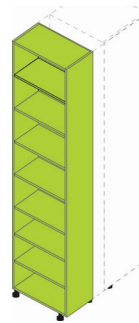

COLONNA TERMINALE LATERALE A GIORNO,
7 ripiani
SIDE OPEN END TALL UNIT,
7 shelves

234	30	61,4	CB61T02
-----	----	------	---------

NOBILITATO colore scocca SP. 1,8 MELAMINE carcass colour TH. 1,8	PET SP. 1,8 PET Ép. 1,8	FENIX SP. 1,8 FENIX Ép. 1,8	TERMO STRUTTURATO SP. 1,8 THERMO TEXTURED TH. 1,8	LAMINATO MATERICO SP. 1,8 TEXTURED LAMINATE TH. 1,8
309	996	1118	473	720
402	1295	1454	615	936

229	697	782	335	503
-----	-----	-----	-----	-----

293	965	1083	441	698
-----	-----	------	-----	-----



ELEMENTI A GIORNO "L10"

"L10" OPEN ELEMENTS

TIPOLOGIA MATERIALE TYPE OF MATERIAL	COLORI COLOURS					DISPONIBILE NEI MODELLI AVAILABLE IN MODELS	
NOBILITATO MELAMINE	BIANCO ICE	CANAPA	PLATINO	OMBRA	LAVAREDO	ASPARAGO	UNIVERSAL
	PELTRO L0068	CURCUMA					

ELEMENTI A GIORNO "L10", per basi

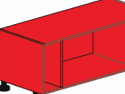
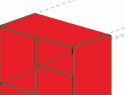
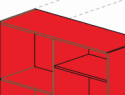
"L10" OPEN ELEMENTS, for base units

ARTICOLO ARTICLE	DESCRIZIONE DESCRIPTION	H.(cm) H.(cm)	PROF.(cm) DEPTH (cm)	LARGH.(cm) WIDTH (cm)	CODICE CODE
	ELEMENTO A GIORNO PER BASE OPEN ELEMENTS FOR BASE UNIT	39	36,4	60	TL60035
	ELEMENTO A GIORNO PER BASE OPEN ELEMENTS FOR BASE UNIT	39	36,4	90	TL90025
	ELEMENTO A GIORNO PER BASE OPEN ELEMENTS FOR BASE UNIT	78 / 81	30	61,4	TL61006
	ELEMENTO A GIORNO PER ISOLA/PENISOLA OPEN ELEMENTS FOR ISLAND/PENINSULA	78 / 81	30	88,9	TL89000
	ELEMENTO A GIORNO PER BASE OPEN ELEMENTS FOR BASE UNIT	78	36,4	30	TL30071

 NO SISTEMA COLA
NO GROOVE SYSTEM

ELEMENTI A GIORNO "L10"



"L10" OPEN ELEMENTS

TIPOLOGIA MATERIALE TYPE OF MATERIAL	COLORI COLOURS					DISPONIBILE NEI MODELLI AVAILABLE IN MODELS	
LAMINATO MATERICO TEXTURED LAMINATE	CALCE	CEMENTO	CEMENTO BIANCO	CEMENTO VISONE	CEMENTO DARK	METROPOLIS	
TERMO STRUTTURATO THERMO STRUCTURED	LARICE BROWN	LARICE SABBIA	ROVERE NODATO	ROVERE NATURA	NOCE EUCALIPTO	ROVERE SOLE	METROPOLIS

TERMO STRUTTURATO SP. 1,2 THERMO TEXTURED TH. 1,2	LAMINATO MATERICO SP. 1,2 TEXTURED LAMINATE TH. 1,2	NOBILITATO SP. 1,2 MELAMINE TH. 1,2
263	263	263
340	340	340
390	390	390
502	502	502
304	304	304

ELEMENTI A GIORNO "L10", per pensili

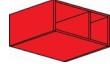
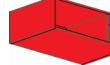
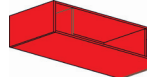
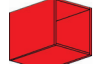
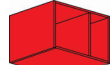

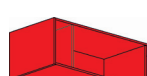
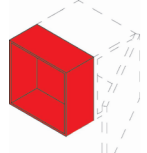
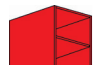
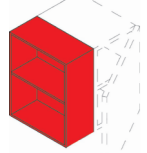
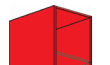

"L10" OPEN ELEMENTS, for wall units

ARTICOLO ARTICLE	DESCRIZIONE DESCRIPTION	H.(cm) H.(cm)	PROF. (cm) DEPTH (cm)	LARGH. (cm) WIDTH (cm)	CODICE CODE
	ELEMENTO A GIORNO PER PENSILE OPEN ELEMENTS FOR WALL UNIT	24	36,4	45	TL45021
	ELEMENTO A GIORNO PER PENSILE OPEN ELEMENTS FOR WALL UNIT	24	36,4	60	TL60031
	ELEMENTO A GIORNO PER PENSILE OPEN ELEMENTS FOR WALL UNIT	24	36,4	90	TL90021
	ELEMENTO A GIORNO PER PENSILE OPEN ELEMENTS FOR WALL UNIT	36	36,4	30	TL30053
	ELEMENTO A GIORNO PER PENSILE OPEN ELEMENTS FOR WALL UNIT	36	36,4	45	TL45023
	ELEMENTO A GIORNO PER PENSILE OPEN ELEMENTS FOR WALL UNIT	36	36,4	60	TL60033
	ELEMENTO A GIORNO PER PENSILE OPEN ELEMENTS FOR WALL UNIT	36	36,4	90	TL90023
	NEW ELEMENTO A GIORNO TERMINALE LATERALE PER PENSILE OPEN ELEMENTS SIDE TERMINAL FOR WALL UNIT	<small>DX</small> 36 <small>RH</small> 36 <small>SX</small> 36 <small>LH</small>	34	15	TL34000
	ELEMENTO A GIORNO PER PENSILE OPEN ELEMENTS FOR WALL UNIT	48	36,4	30	TL30055
	NEW ELEMENTO A GIORNO TERMINALE LATERALE PER PENSILE OPEN ELEMENTS SIDE TERMINAL FOR WALL UNIT	<small>DX</small> 48 <small>RH</small> 48 <small>SX</small> 48 <small>LH</small>	34	15	TL34002
	ELEMENTO A GIORNO PER PENSILE OPEN ELEMENTS FOR WALL UNIT	60	36,4	30	TL30057

TERMO STRUTTURATO SP. 1,2 THERMO TEXTURED TH. 1,2	LAMINATO MATERICO SP. 1,2 TEXTURED LAMINATE TH. 1,2	NOBILITATO SP. 1,2 MELAMINE TH. 1,2
210	210	210
242	242	242
297	297	297
188	188	188
241	241	241
265	265	265
333	333	333
197	197	197
197	197	197
215	215	215
223	223	223
223	223	223
243	243	243

ELEMENTI A GIORNO "L10", per pensili

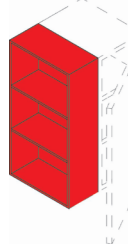
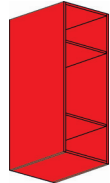

"L10" OPEN ELEMENTS, for wall units

ARTICOLO ARTICLE	DESCRIZIONE DESCRIPTION	H.(cm) H.(cm)	PROF. (cm) DEPTH (cm)	LARGH. (cm) WIDTH (cm)	CODICE CODE	
	ELEMENTO A GIORNO TERMINALE LATERALE PER PENSILE OPEN ELEMENTS SIDE TERMINAL FOR WALL UNIT	DX RH SX LH	60	34	15	TL34004
			60	34	15	TL34004
	ELEMENTO A GIORNO PER PENSILE OPEN ELEMENTS FOR WALL UNIT		72	36,4	30	TL30047
	ELEMENTO A GIORNO TERMINALE LATERALE PER PENSILE OPEN ELEMENTS SIDE TERMINAL FOR WALL UNIT	DX RH SX LH	72	34	15	TL34006
			72	34	15	TL34006
	ELEMENTO A GIORNO PER PENSILE OPEN ELEMENTS FOR WALL UNIT		96	36,4	30	TL30049
	ELEMENTO A GIORNO PER PENSILE OPEN ELEMENTS FOR WALL UNIT		108	36,4	30	TL30051

TERMO STRUTTURATO SP. 1,2 THERMO TEXTURED TH. 1,2	LAMINATO MATERICO SP. 1,2 TEXTURED LAMINATE TH. 1,2	NOBILITATO SP. 1,2 MELAMINE TH. 1,2
235	235	235
235	235	235
291	291	291
260	260	260
260	260	260
327	327	327
357	357	357

ELEMENTI A GIORNO "L10", per colonne

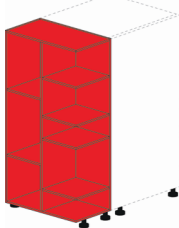
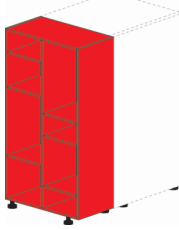
"L10" OPEN ELEMENTS, for tall units

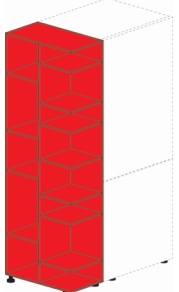
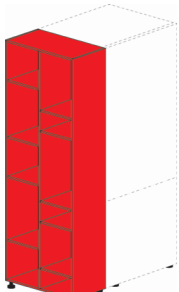
ARTICOLO ARTICLE	DESCRIZIONE DESCRIPTION	H.(cm) H.(cm)	PROF. (cm) DEPTH (cm)	LARGH. (cm) WIDTH (cm)	CODICE CODE	
	ELEMENTO A GIORNO PER COLONNA OPEN ELEMENTS FOR TALL UNIT	138	36,4	30	TL30045	
	ELEMENTO A GIORNO PER COLONNA, terminale laterale OPEN ELEMENTS FOR TALL UNIT, side open end	DX RH	138	29,85	59	TL59000
			SX LH	138	29,85	59
	ELEMENTO A GIORNO PER COLONNA, terminale laterale OPEN ELEMENTS FOR TALL UNIT, side open end	138	30	61,4	TL61004	
	ELEMENTO A GIORNO PER COLONNA OPEN ELEMENTS FOR TALL UNIT	210	36,4	30	TL30059	
	ELEMENTO A GIORNO PER COLONNA, terminale laterale OPEN ELEMENTS FOR TALL UNIT, side open end	DX RH	210	29,85	59	TL59002
			SX LH	210	29,85	59
	ELEMENTO A GIORNO PER COLONNA, terminale laterale OPEN ELEMENTS FOR TALL UNIT, side open end	210	30	61,4	TL61002	

TERMO STRUTTURATO SP. 1,2 THERMO TEXTURED TH. 1,2	LAMINATO MATERICO SP. 1,2 TEXTURED LAMINATE TH. 1,2	NOBILITATO SP. 1,2 MELAMINE TH. 1,2
426	426	426
621	621	621
621	621	621
426	426	426
581	581	581
797	797	797
797	797	797
819	819	819

VANI A GIORNO IN METALLO "L10", sp. 0,2 cm

"L10" METAL OPEN COMPARTMENTS, TH. 0,2 cm

TIPOLOGIA MATERIALE TYPE OF MATERIAL	COLORI COLOURS						DISPONIBILE NEI MODELLI AVAILABLE IN MODELS
METALLO VERNICIATO LACCATO OPACO PAINTED METAL MATT LACQUERED	BIANCO ICE Opaco	NERO Opaco	CANAPA Opaco	CURCUMA Opaco	LAVAREDO Opaco	BORGOGNA Opaco	UNIVERSAL
	GRIGIO DAYTONA Opaco	GINEPRO Opaco	ASPARAGO Opaco	OLIVA Opaco			

Tempi di consegna n° 4
settimane dalla conferma
dell'ordine
For on-demand colours, the
delivery time is 4 weeks from
the order confirmation



VANI A GIORNO IN METALLO "L10", per basi

"L10" METAL OPEN COMPARTMENTS, for base units

ELEMENTO NON MODIFICABILE
NON MODIFIABLE ELEMENT

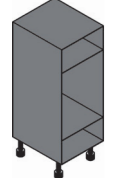
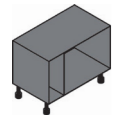
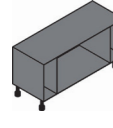
ARTICOLO ARTICLE	DESCRIZIONE DESCRIPTION	H.(cm) H.(cm)	PROF. (cm) DEPTH (cm)	LARGH. (cm) WIDTH (cm)	CODICE CODE	PTS.
	ELEMENTO A GIORNO PER BASI OPEN ELEMENTS FOR BASE UNITS	78	36,4	30	TL30071	278
	ELEMENTO A GIORNO PER BASI OPEN ELEMENTS FOR BASE UNITS	39	36,4	60	TL60035	262
	ELEMENTO A GIORNO PER BASI OPEN ELEMENTS FOR BASE UNITS	39	36,4	90	TL90025	322







Non possibile posizionare come elemento terminale o con lati a vista
It cannot be positioned as an end element or with visible sides

VANI A GIORNO IN METALLO "L10", per pensili

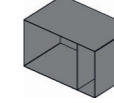
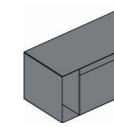
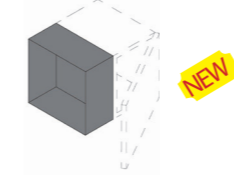
"L10" METAL OPEN COMPARTMENTS, for wall units

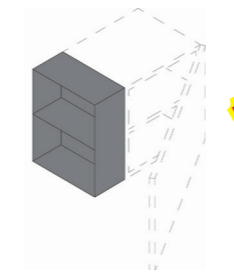

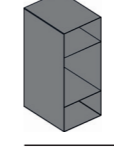
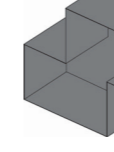
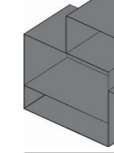
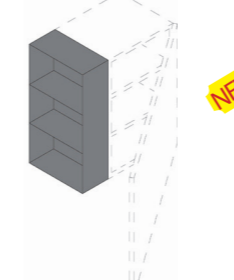
ELEMENTO NON MODIFICABILE
NON MODIFIABLE ELEMENT

ARTICOLO ARTICLE	DESCRIZIONE Description	H.(cm) H.(cm)	PROF. (cm) DEPTH (cm)	LARGH. (cm) WIDTH (cm)	CODICE CODE	PTS.
	ELEMENTO A GIORNO PER PENSILE OPEN ELEMENTS FOR WALL UNIT	36	36,4	30	TL30053	174
	ELEMENTO A GIORNO PER PENSILE OPEN ELEMENTS FOR WALL UNIT	36	36,4	60	TL60033	262
	ELEMENTO A GIORNO PER PENSILE OPEN ELEMENTS FOR WALL UNIT	36	36,4	90	TL90023	322
	ELEMENTO TERMINALE LATERALE A GIORNO PER PENSILE OPEN SIDE TERMINAL ELEMENT FOR WALL UNIT	36	34	15	TL34000	212
		36	34	15	TL34000	212
	ELEMENTO A GIORNO PER PENSILE OPEN ELEMENTS FOR WALL UNIT	48	36,4	30	TL30055	218
	ELEMENTO TERMINALE LATERALE A GIORNO PER PENSILE OPEN SIDE TERMINAL ELEMENT FOR WALL UNIT	48	34	15	TL34002	244
		48	34	15	TL34002	244
		60	34	15	TL34004	308
		60	34	15	TL34004	308
	ELEMENTO A GIORNO PER PENSILE OPEN ELEMENTS FOR WALL UNIT	60	36,4	30	TL30057	252
	ELEMENTO A GIORNO PER PENSILE OPEN ELEMENTS FOR WALL UNIT	72	36,4	30	TL30047	278
	ELEMENTO A GIORNO PER PENSILE OPEN ELEMENTS FOR WALL UNIT	72	36,4	90	TL90026	366
		72	36,4	90	TL90026	366
	ELEMENTO A GIORNO PER PENSILE OPEN ELEMENTS FOR WALL UNIT	72	36,4	90	TL90028	407
	ELEMENTO TERMINALE LATERALE A GIORNO PER PENSILE OPEN SIDE TERMINAL ELEMENT FOR WALL UNIT	72	34	15	TL34006	349
		72	34	15	TL34006	349

VANI A GIORNO IN METALLO "L10", per pensili

ELEMENTO NON MODIFICABILE
NON MODIFIABLE ELEMENT

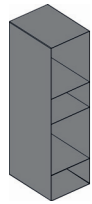
"L10" METAL OPEN COMPARTMENTS, for wall units

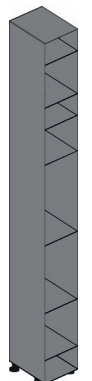
ARTICOLO ARTICLE	DESCRIZIONE Description	H.(cm) H.(cm)	PROF. (cm) DEPTH (cm)	LARGH. (cm) WIDTH (cm)	CODICE CODE	PTS.
	ELEMENTO A GIORNO PER PENSILE OPEN ELEMENTS FOR WALL UNIT	108	36,4	30	TL30051	382
	ELEMENTO A GIORNO PER COLONNA OPEN ELEMENTS FOR TALL UNIT	138	36,4	30	TL30045	401
	ELEMENTO A GIORNO PER COLONNA OPEN ELEMENTS FOR TALL UNIT	210	36,4	30	TL30059	564



NICCHIE IN METALLO, in appoggio al top

ELEMENTO NON MODIFICABILE
NON MODIFIABLE ELEMENT

METAL RESESS, supporting top

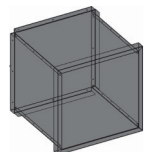
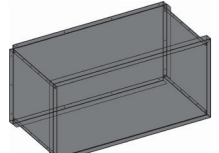
ARTICOLO ARTICLE	DESCRIZIONE Description	H.(cm) H.(cm)	PROF. (cm) DEPTH (cm)	LARGH. (cm) WIDTH (cm)	CODICE CODE	PTS.
	NICCHIA A GIORNO IN APPOGGIO SUPPORTING OPEN RECESS	60	58	65	TL65000	209
	PER SISTEMA GOLA FOR SYSTEM GROOVE	57	58	65	TL65001	209
	NICCHIA A GIORNO IN APPOGGIO SUPPORTING OPEN RECESS	60	58	125	TL1A000	293
	PER SISTEMA GOLA FOR SYSTEM GROOVE	57	58	125	TL1A001	293



Non possibile posizionare come elemento terminale o con lati a vista
It cannot be positioned as an end element or with visible sides



Disponibile solo con piani in accosto uguale o minore a sp. 3 cm;
Disponibili solo in versione incassata tra due colonne (non possibile posizionate con lato a vista)

Available only with surfaces equally together or less than 3 cm thick;
Available only for recessed installation between two columns (not can positioned with the visible side)

ELEMENTI IN METALLO

METAL ELEMENTS

TIPOLOGIA MATERIALE TYPE OF MATERIAL	COLORI COLOURS	DISPONIBILE NEI MODELLI AVAILABLE IN MODELS
---	-------------------	--

METALLO VERNICIATO
LACCATO OPACO
PAINTED METAL
MATT LACQUERED

BIANCO OPACO NERO OPACO TITANIO **NEW**

UNIVERSALE
UNIVERSAL

Tempi di consegna n° 4
settimane dalla conferma
dell'ordine

For on-demand colours, the
delivery time is 4 weeks from
the order confirmation



STRUTTURA STRUCTURE	DESCRIZIONE DESCRIPTION	H.(cm) H.(cm)	PR.(cm) D.(cm)	L.(cm) W.(cm)	CODICE CODE	PTS.	
	BASAMENTO "DIAGONAL", per appoggio basi sospese struttura metallo in finitura: Peltro, Bianco Opaco, Nero Opaco	NEW Titanio	36	40	120	ZN12000	186
		Bianco Opaco	36	40	120	ZN12000	186
		Nero Opaco	36	40	120	ZN12000	186
	"DIAGONAL" BASE UNIT, to support suspended base units metal structure with finish: Pewter, Mat White, Nero Opaco	NEW Titanio	36	40	150	ZN15000	189
		Bianco Opaco	36	40	150	ZN15000	189
		Nero Opaco	36	40	150	ZN15000	189
	NEW	Titanio	36	40	210	ZN21000	196
		Bianco Opaco	36	40	210	ZN21000	196
		Nero Opaco	36	40	210	ZN21000	196

VANI A GIORNO "SIZE", sp. 1,2 cm

"SIZE" OPEN COMPARTMENTS, TH. 1,2 cm

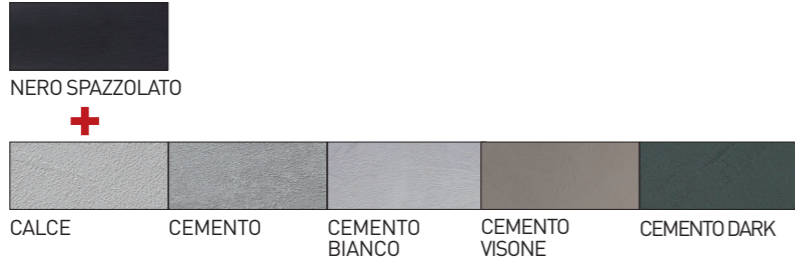
TIPOLOGIA MATERIALE TYPE OF MATERIAL	COLORI COLOURS	DISPONIBILE NEI MODELLI AVAILABLE IN MODELS
ALLUMINIO ALUMINIUM + LAMINATO MATERICO TEXTURED LAMINATE	 <p>NERO SPAZZOLATO</p> <p>CALCE CEMENTO CEMENTO BIANCO CEMENTO VISONE CEMENTO DARK</p>	METROPOLIS
Tempi di consegna n° 4 settimane dalla conferma dell'ordine For on-demand colours, the delivery time is 4 weeks from the order confirmation		

TIPOLOGIA MATERIALE TYPE OF MATERIAL	COLORI COLOURS	DISPONIBILE NEI MODELLI AVAILABLE IN MODELS
ALLUMINIO ALUMINIUM + TERMO STRUTTURATO THERMO STRUCTURED	 <p>NERO SPAZZOLATO</p> <p>LARICE BROWN LARICE SABBIA ROVERE NODATO ROVERE NATURA NOCE EUCALIPTO ROVERE SOLE</p>	METROPOLIS
Tempi di consegna n° 4 settimane dalla conferma dell'ordine For on-demand colours, the delivery time is 4 weeks from the order confirmation		

VANI A GIORNO "SIZE", per pensili

"SIZE" OPEN COMPARTMENTS, for wall units

ELEMENTO NON MODIFICABILE
NON MODIFIABLE ELEMENT

ALLUMINIO + LAMINATO MATERICO
ALUMINIUM + TEXTURED LAMINATE
ALLUMINIO + TERMO STRUTTURATO
ALUMINIUM + THERMO STRUCTURED

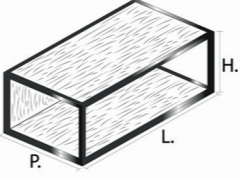
ARTICOLO ARTICLE	DESCRIZIONE DESCRIPTION	H.(cm) H.(cm)	PROF. (cm) DEPTH (cm)	LARGH. (cm) WIDTH (cm)	CODICE CODE	419	419
	ELEMENTO A GIORNO PER PENSILE OPEN ELEMENTS FOR WALL UNIT	24	34	60	TL60036	419	419
		24	34	90	TL90029	490	490

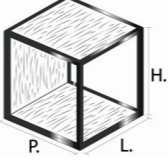
ARTICOLO ARTICLE	DESCRIZIONE DESCRIPTION	H.(cm) H.(cm)	PROF. (cm) DEPTH (cm)	LARGH. (cm) WIDTH (cm)	CODICE CODE	375	375
	ELEMENTO A GIORNO PER PENSILE OPEN ELEMENTS FOR WALL UNIT	36	34	30	TL30061	375	375
		36	34	60	TL60037	446	446
		36	34	90	TL90030	514	514

ARTICOLO ARTICLE	DESCRIZIONE DESCRIPTION	H.(cm) H.(cm)	PROF. (cm) DEPTH (cm)	LARGH. (cm) WIDTH (cm)	CODICE CODE	482	482
	ELEMENTO A GIORNO PER PENSILE OPEN ELEMENTS FOR WALL UNIT	60	34	30	TL30062	482	482
		60	34	60	TL60038	607	607
		72	34	30	TL30063	496	496
		72	34	60	TL60039	629	629

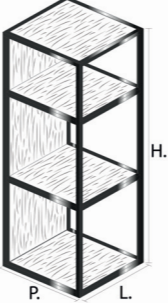
ARTICOLO ARTICLE	DESCRIZIONE DESCRIPTION	H.(cm) H.(cm)	PROF. (cm) DEPTH (cm)	LARGH. (cm) WIDTH (cm)	CODICE CODE	602	602
	ELEMENTO A GIORNO PER PENSILE OPEN ELEMENTS FOR WALL UNIT	96	34	30	TL30064	602	602
		96	34	60	TL60040	768	768

ELEMENTI PALO ALTO, boiserie

PALO ALTO ELEMENTS, boiserie

SCHEMA COMPOSIZIONE
COMPOSITION LAYOUT

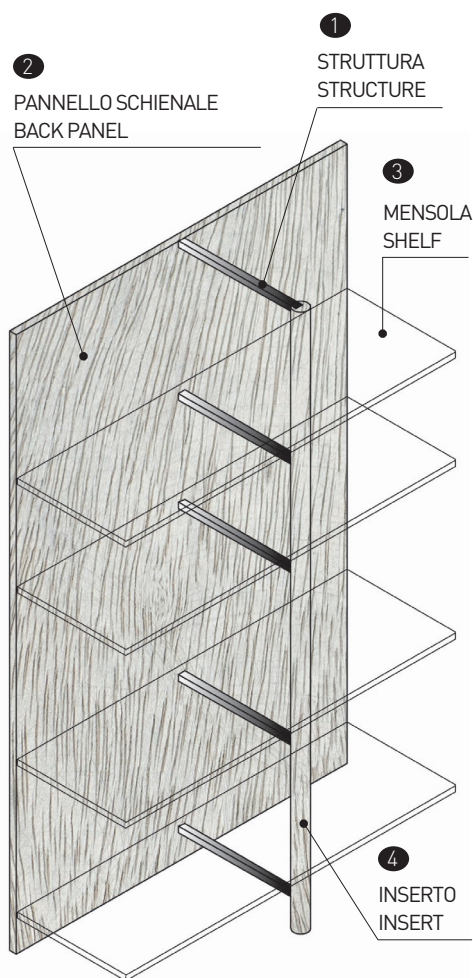

Elemento Palo alto composto da:

- ① **STRUTTURA** Alluminio
- ② **PANNELLO SCHIENALE** Impiallacciato / Fenix / Laminato Materico / Termo Strutturato
- ③ **MENSOLA** Impiallacciato / Laccato lucido spazzolato / Laccato opaco / Laccato decor / Laminato Materico / Termo Strutturato
- ④ **INSERTO** Impiallacciato (OPTIONAL)

Palo alto element comprising:

- ① **Aluminium** STRUCTURE
- ② **Veneered / Fenix / Textured laminate / Thermo Structured** BACK PANEL
- ③ **Veneered / Gloss lacquered brushed / Matt lacquered / Decor lacquered / Textured Laminate / Thermo Structured** SHELF
- ④ **Veneered** INSERT (OPTIONAL)

COME SI COMPONE IL PREZZO :

Il prezzo si compone scegliendo la tipologia di elemento PALO ALTO (esempio "boiserie"). Sommare i prezzi del pannello con struttura alluminio + prezzi della mensola + prezzo dell'inserto (quest'ultimo articolo non è necessario, va considerato come optional). Aggiungere il prezzo del pannello compensatore solamente nelle situazioni in cui è richiesto.





HOW TO DO THE PRICE:

The price is made by choosing the type of element PALO ALTO (example "boiserie"). Add up the prices of the panel with aluminum structure + prices of the shelf + price of the insert (this last article is not necessary, it should be considered as an optional). Add the price of the compensating panel only in the situations in which it is required.

ARTICOLO ARTICLE	DESCRIZIONE DESCRIZIONE	TIPOLOGIA MATERIALE TYPE OF MATERIAL	COLORI COLOURS
	① Struttura Structure	ALLUMINIO ALUMINIUM	 NERO SPAZZOLATO
	② Pannello Schienale Back Panel	IMPIALLACCIATO VENEERED	
		FENIX FENIX	
		LAMINATO MATERICO TEXTURED LAMINATE	
		TERMO STRUTTURATO THERMO STRUCTURED	

ELEMENTI PALO ALTO

PALO ALTO ELEMENTS

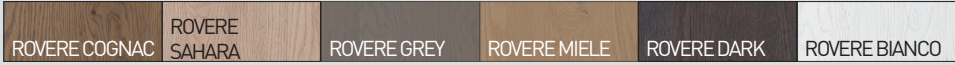
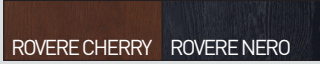
ARTICOLO ARTICLE	DESCRIZIONE DESCRIZIONE	TIPOLOGIA MATERIALE TYPE OF MATERIAL	COLORI COLOURS
	3 Mensola Shelf	LAMINATO MATERICO TEXTURED LAMINATE TERMO STRUTTURATO THERMO STRUCTURED	  LARICE BROWN LARICE SABBIA NOCE EUCALIPTO ROVERE SOLE
	4 Inserto Insert	IMPIALLACCIATO VENEERED	  ROVERE COGNAC ROVERE SAHARA ROVERE GREY ROVERE MIELE ROVERE DARK ROVERE BIANCO ROVERE CHERRY ROVERE NERO

ELEMENTI PALO ALTO, boiserie (tipo 1)

PALO ALTO ELEMENTS, boiserie (type 1)

BOISERIE PER RETRO BASE H. 86/89 PER ISOLA E PENISOLA
BOISERIE FOR WALL UNIT BEHIND H. 86/89 FOR ISLAND AND PENINSULA

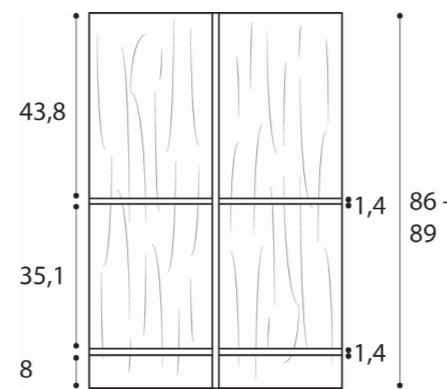
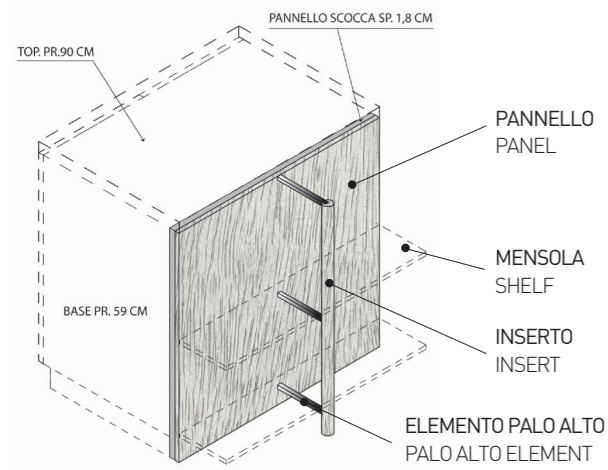

ARTICOLO ARTICLE	DESCRIZIONE DESCRIPTION	LARGH. (cm) WIDTH (cm)	CODICE CODE
---------------------	----------------------------	---------------------------	----------------

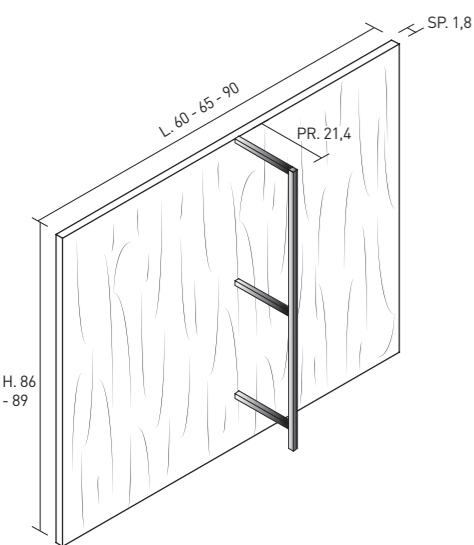

ELEMENTO "PALO ALTO" + PANNELLO
"PALO ALTO" ELEMENT + PANEL

60	BP60Z00
65	BP65Z00
90	BP90Z00

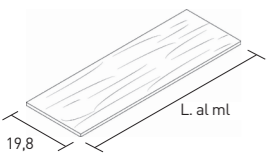

MENSOLA SP. 1,4 CM
(lunghezza max. 270 cm)
SHELF TH. 1,4 CM
(length max. 270 cm)

L. at ml MV19001

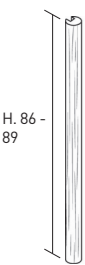

MAGGIORAZIONE PER INSERTO Ø 4 CM
SURCHARGES FOR INSERT Ø 4 CM

H. 86/89 -

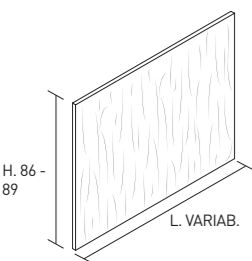

PANNELLO DI COMPENSAZIONE SP. 1,8 CM AL ML
(Lunghezza variabile)
COMPENSATION BACK PANEL TH. 1,8 CM PER LM
(length variable)

H.86/89 x L. da 25 a 120 BP00P00

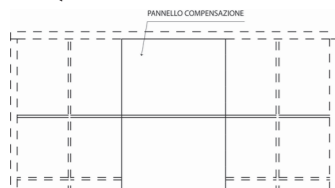

TERMO STRUTTURATO THERMO STRUCTURED	LAMINATO MATERICO TEXTURED LAMINATE	FENIX FENIX	IMPIALLACCIATO VENEERED
227	227	312	379
233	233	350	391
269	269	350	455

77	68	-	173
----	----	---	-----

-	-	-	98
---	---	---	----

201	201	293	378
-----	-----	-----	-----

ELEMENTI PALO ALTO, boiserie (tipo 2)

PALO ALTO ELEMENTS, boiserie (type 2)

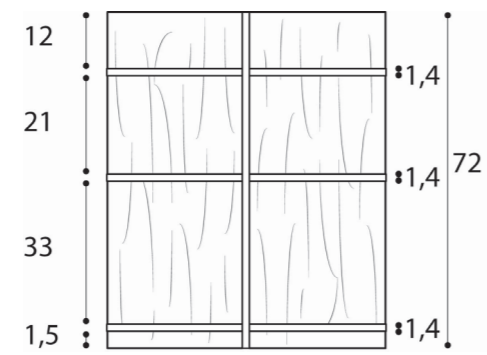
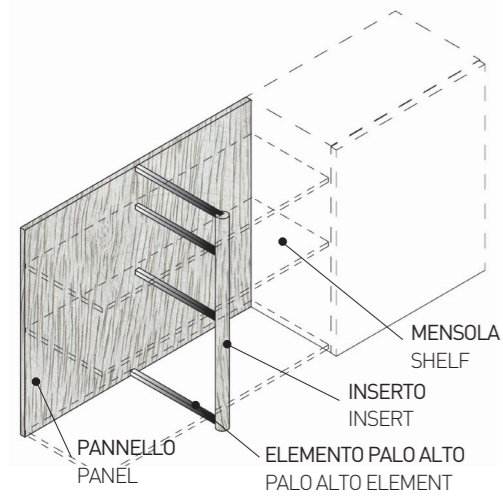
BOISERIE PER PENSILE H. 72 A PARETE SOSPESO
BOISERIE FOR WALL UNIT H. 72 WALL SUSPENDED

ARTICOLO ARTICLE	DESCRIZIONE DESCRIPTION	LARGH. (cm) WIDTH (cm)	CODICE CODE
---------------------	----------------------------	---------------------------	----------------

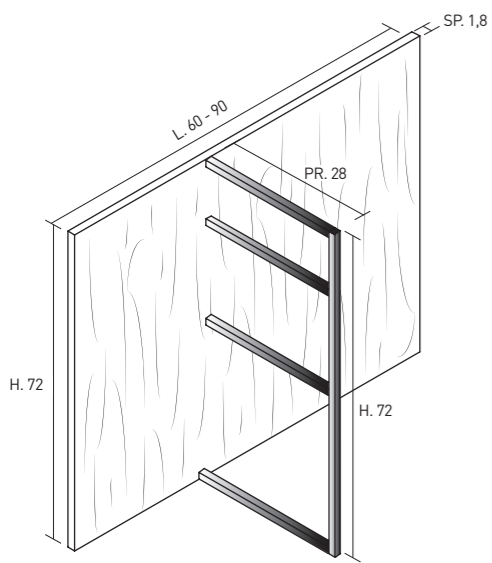
ELEMENTO "PALO ALTO" + PANNELLO
"PALO ALTO" ELEMENT + PANEL

60	BP60Z01
90	BP90Z01

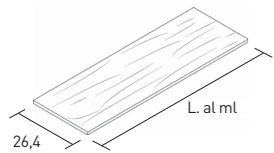
MENSOLA SP. 1,4 CM
(lunghezza max. 270 cm)
SHELF TH. 1,4 CM
(length max. 270 cm)

L. al ml	MV26001
----------	---------

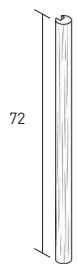
MAGGIORAZIONE PER INSERTO Ø 4 CM
SURCHARGES FOR INSERT Ø 4 CM

H. 72	-
-------	---

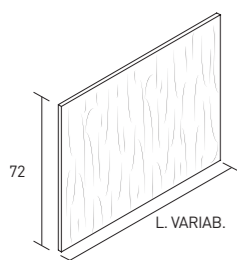
PANNELLO DI COMPENSAZIONE SP. 1,8 CM AL ML
(Lunghezza variabile)
COMPENSATION BACK PANEL TH. 1,8 CM PER LM
(length variable)

H.72 x L. da 25 a 120	BP00P01
-----------------------	---------

TERMO STRUTTURATO THERMO STRUCTURED	LAMINATO MATERICO TEXTURED LAMINATE	FENIX FENIX	IMPIALLACCIATO VENEERED
223	223	278	327
257	257	309	391

96	70	-	191
----	----	---	-----

-	-	-	83
---	---	---	----

189	189	247	321
-----	-----	-----	-----

ELEMENTI PALO ALTO, boiserie (tipo 3)

PALO ALTO ELEMENTS, boiserie (type 3)

BOISERIE PER PENSILE H. 96 A PARETE SOSPESO
BOISERIE FOR WALL UNIT H. 96 WALL SUSPENDED

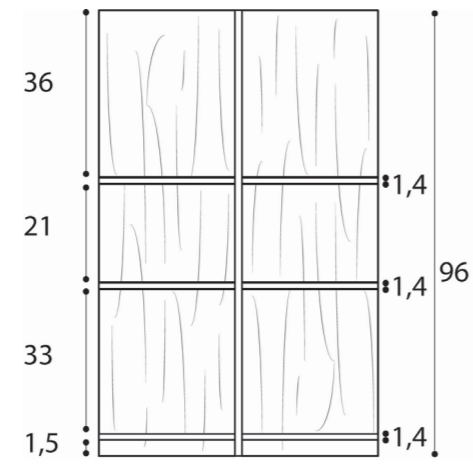
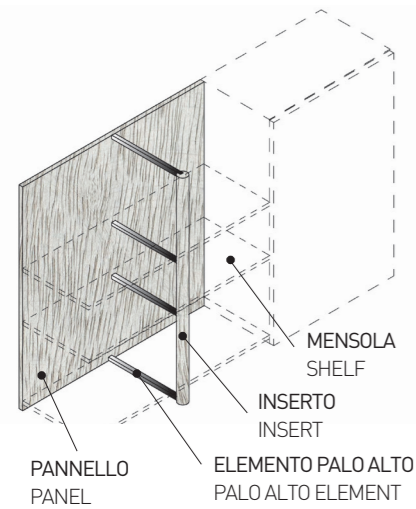

ARTICOLO ARTICLE	DESCRIZIONE DESCRIPTION	LARGH. (cm) WIDTH (cm)	CODICE CODE
---------------------	----------------------------	---------------------------	----------------

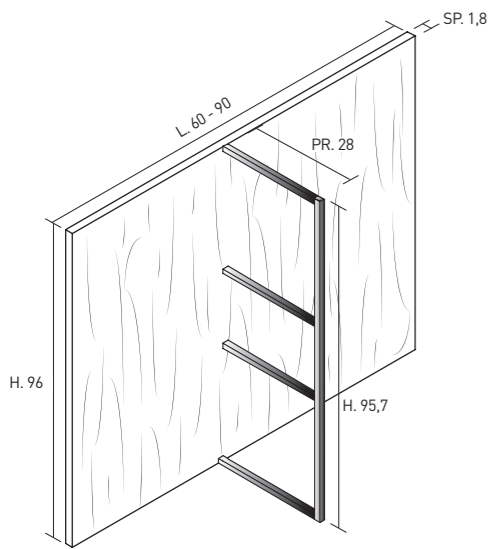

ELEMENTO "PALO ALTO" + PANNELLO
"PALO ALTO" ELEMENT + PANEL

60	BP60Z02
90	BP90Z02

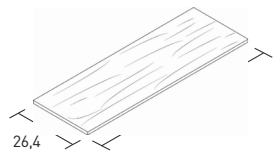

MENSOLA SP. 1,4 CM
(lunghezza max. 270 cm)
SHELF TH. 1,4 CM
(length max. 270 cm)

L. al ml	MV26001
----------	---------

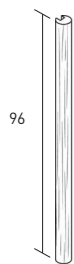

MAGGIORAZIONE PER INSERTO Ø 4 CM
SURCHARGES FOR INSERT Ø 4 CM

H. 96	-
-------	---

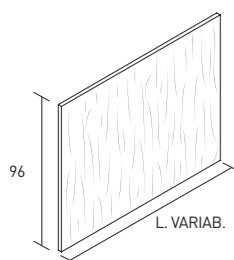

PANNELLO DI COMPENSAZIONE SP. 1,8 CM AL ML
(Lunghezza variabile)
COMPENSATION BACK PANEL TH. 1,8 CM PER LM
(length variable)

H.96 x L. da 25 a 120	BP00P02
-----------------------	---------

TERMO STRUTTURATO THERMO STRUCTURED	LAMINATO MATERICO TEXTURED LAMINATE	FENIX FENIX	IMPIALLACCIATO VENEERED
265	265	318	400
311	311	360	480

96	70	-	191
----	----	---	-----

-	-	-	98
---	---	---	----

228	228	290	367
-----	-----	-----	-----

ELEMENTI PALO ALTO, boiserie (tipo 4)

PALO ALTO ELEMENTS, boiserie (type 4)

BOISERIE H. 146 A PARETE FINO A TERRA
BOISERIE H. 146 WALL TO THE GROUND

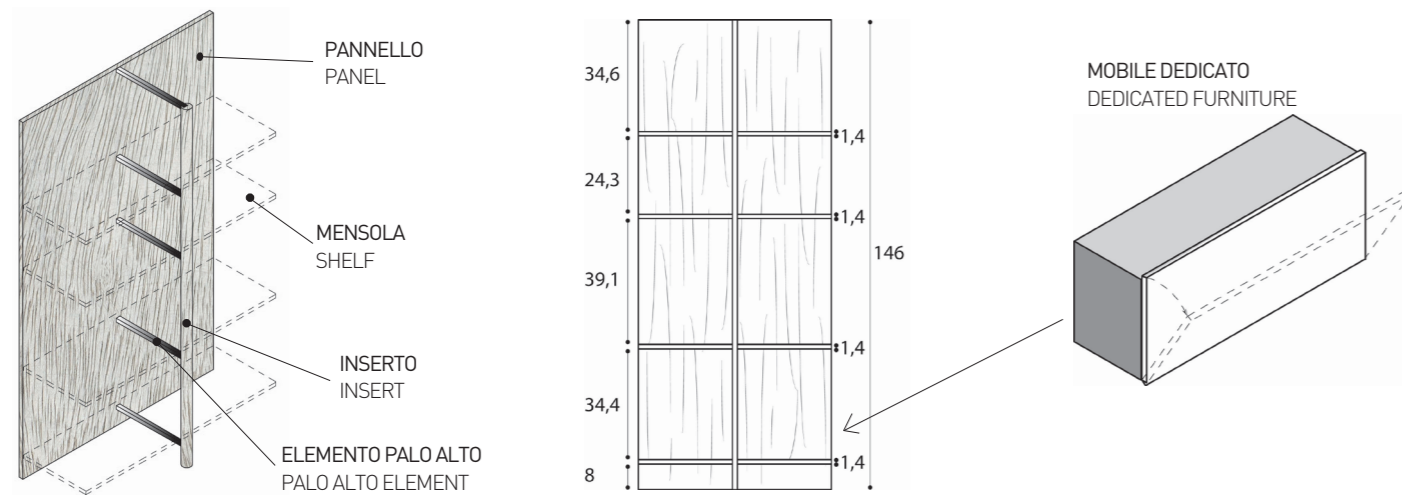

ARTICOLO ARTICLE	DESCRIZIONE DESCRIPTION	LARGH. (cm) WIDTH (cm)	CODICE CODE
---------------------	----------------------------	---------------------------	----------------

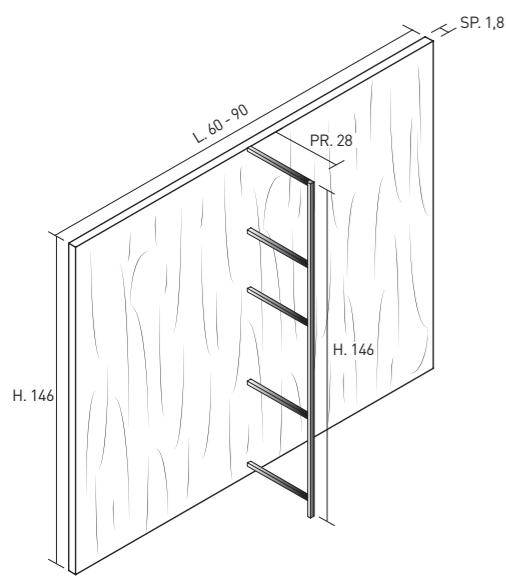

ELEMENTO "PALO ALTO" + PANNELLO
"PALO ALTO" ELEMENT + PANEL

60	BP60Z03
90	BP90Z03

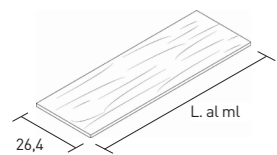

MENSOLA SP. 1,4 CM
(lunghezza max. 270 cm)
SHELF TH. 1,4 CM
(length max. 270 cm)

L. al mt	MV26001
----------	---------

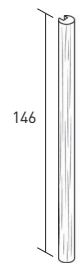

MAGGIORAZIONE PER INSERTO Ø 4 CM
SURCHARGES FOR INSERT Ø 4 CM

H. 146	-
--------	---

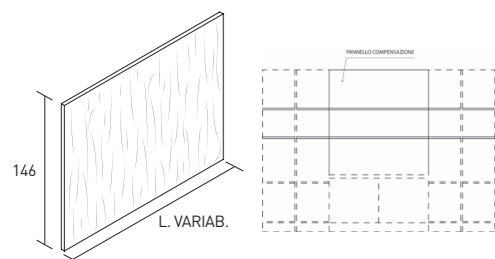

PANNELLO DI COMPENSAZIONE SP. 1,8 CM AL ML
(Lunghezza variabile)
COMPENSATION BACK PANEL TH. 1,8 CM PER LM
(length variable)

H.146 x L. da 25 a 120	BP00P03
------------------------	---------

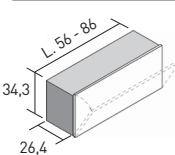

PENSILE 1 ANTA RIBALTA
WALL UNIT 1 DOOR OPEN FLAP

56	PS56B00
86	PS86B00



TERMO STRUTTURATO THERMO STRUCTURED	LAMINATO MATERICO TEXTURED LAMINATE	FENIX FENIX	IMPIALLACCIATO VENEERED
340	340	426	548
410	410	487	670

96	70	-	191
----	----	---	-----

-	-	-	131
---	---	---	-----

285	285	393	515
-----	-----	-----	-----

E1	E2	E4
192	197	216
217	224	249

ELEMENTI PALO ALTO, boiserie (tipo 5)

PALO ALTO ELEMENTS, boiserie (type 5)

BOISERIE H. 218 A PARETE FINO A TERRA
BOISERIE H. 218 WALL TO THE GROUND

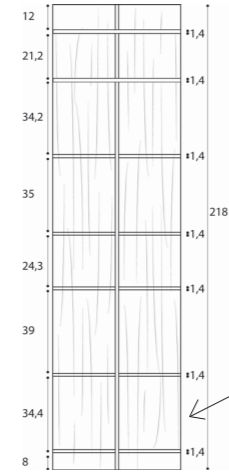
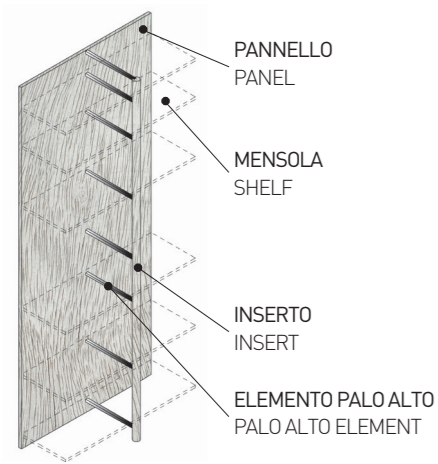

MOBILE DEDICATO
DEDICATED FURNITURE

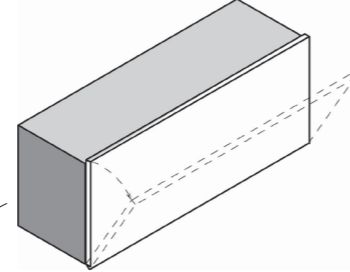

ARTICOLO ARTICLE	DESCRIZIONE DESCRIPTION	LARGH. (cm) WIDTH (cm)	CODICE CODE
---------------------	----------------------------	---------------------------	----------------

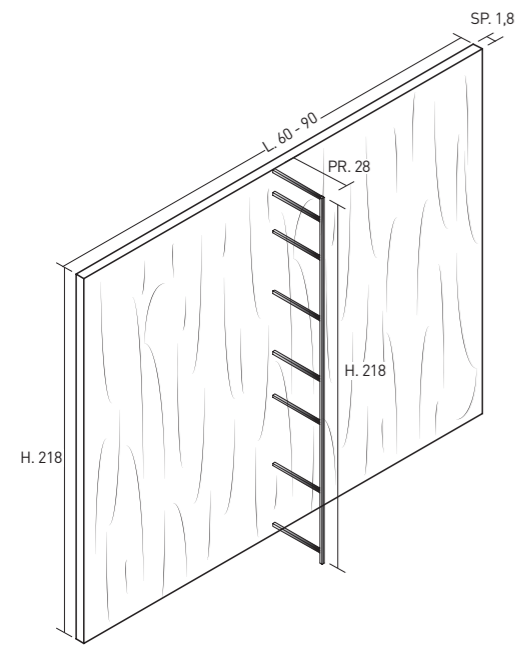

ELEMENTO "PALO ALTO" + PANNELLO
"PALO ALTO" ELEMENT + PANEL

60	BP60Z04
90	BP90Z04

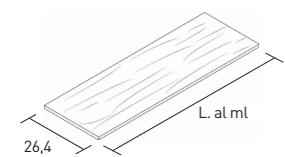

MENSOLA SP. 1,4 CM
(lunghezza max. 270 cm)
SHELF TH. 1,4 CM
(length max. 270 cm)

L. al ml	MV26001
----------	---------



MAGGIORAZIONE PER INSERTO Ø 4 CM
SURCHARGES FOR INSERT Ø 4 CM

H. 218	-
--------	---

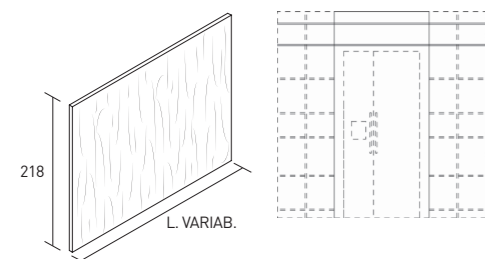

PANNELLO DI COMPENSAZIONE SP. 1,8 CM AL ML
(Lunghezza variabile)
COMPENSATION BACK PANEL TH. 1,8 CM PER LM
(length variable)

H.218 x L. da 25 a 120	BP00P04
------------------------	---------

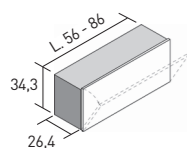

PENSILE 1 ANTA RIBALTA
WALL UNIT 1 DOOR OPEN FLAP

56	PS56B00
86	PS86B00

TERMO STRUTTURATO THERMO STRUCTURED	LAMINATO MATERICO TEXTURED LAMINATE	FENIX FENIX	IMPIALLACCIATO VENEERED
541	541	591	781
646	646	682	957

96	70	-	191
----	----	---	-----

-	-	-	184
---	---	---	-----

418	418	535	711
-----	-----	-----	-----

E1	E2	E4
192	197	216
217	224	249

ELEMENTI PALO ALTO, libreria

PALO ALTO ELEMENTS, bibliography

SCHEMA COMPOSIZIONE
COMPOSITION LAYOUT

Elemento Palo alto composto da:

- ① **STRUTTURA Alluminio**
- ③ **MENSOLA Impiallacciato / Laccato lucido spazzolato / Laccato opaco / Laccato decor / Laminato Materico/Termo Strutturato / Fenix**
- ④ **INSERTO Impiallacciato (OPTINAL)**

Palo alto element comprising:

- ① **Aluminium STRUCTURE**
- ③ **Veneered / Gloss lacquered brushed / Matt lacquered / Decor lacquered / Textured Laminate/ Thermo Structured / Fenix SHELF**
- ④ **Veneered INSERT (OPTIONAL)**



COME SI COMPONE IL PREZZO :

Il prezzo si compone scegliendo la tipologia di elemento PALO ALTO (esempio "libreria").

Sommare i prezzi della struttura alluminio + prezzi della mensola + prezzo dell'inserto (quest'ultimo articolo non è necessario, va considerato come optional).

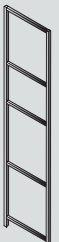
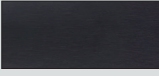

HOW TO DO THE PRICE:

The price is made by choosing the type of element PALO ALTO (example "bibliography"). Add up the prices of the aluminum structure + prices of the shelf + price of the insert (this last article is not necessary, it should be considered as an optional).

ARTICOLO ARTICLE	DESCRIZIONE DESCRIZIONE	TIPOLOGIA MATERIALE TYPE OF MATERIAL	COLORI COLOURS												
	① Struttura Structure	ALLUMINIO ALUMINIUM	 NERO SPAZZOLATO												
	③ Mensola Shelf	FENIX FENIX	<table border="1"> <tr> <td>GRIGIO LONDRA</td> <td>GRIGIO EFESO</td> <td>NERO INGO</td> <td>GRIGIO BROMO</td> <td>BIANCO KOS</td> <td>BEIGE ARIZONA</td> </tr> <tr> <td>GRIGIO ANTRIM</td> <td>ROSSO JAIPUR</td> <td>VERDE COMODORO</td> <td>CASTORO OTTAWA</td> <td>CACAO ORINOCO</td> <td>BLU FES</td> </tr> </table>	GRIGIO LONDRA	GRIGIO EFESO	NERO INGO	GRIGIO BROMO	BIANCO KOS	BEIGE ARIZONA	GRIGIO ANTRIM	ROSSO JAIPUR	VERDE COMODORO	CASTORO OTTAWA	CACAO ORINOCO	BLU FES
GRIGIO LONDRA	GRIGIO EFESO	NERO INGO	GRIGIO BROMO	BIANCO KOS	BEIGE ARIZONA										
GRIGIO ANTRIM	ROSSO JAIPUR	VERDE COMODORO	CASTORO OTTAWA	CACAO ORINOCO	BLU FES										

ELEMENTI PALO ALTO

PALO ALTO ELEMENTS

ARTICOLO ARTICLE	DESCRIZIONE DESCRIZIONE	TIPOLOGIA MATERIALE TYPE OF MATERIAL	COLORI COLOURS												
	③ Mensola Shelf	IMPIALLACCIATO VENEERED	<table border="1"> <tr> <td>ROVERE COGNAC</td> <td>ROVERE SAHARA</td> <td>ROVERE GREY</td> <td>ROVERE MIELE</td> <td>ROVERE DARK</td> <td>ROVERE BIANCO</td> </tr> <tr> <td>ROVERE CHERRY</td> <td>ROVERE NERO</td> <td></td> <td></td> <td></td> <td></td> </tr> </table>	ROVERE COGNAC	ROVERE SAHARA	ROVERE GREY	ROVERE MIELE	ROVERE DARK	ROVERE BIANCO	ROVERE CHERRY	ROVERE NERO				
ROVERE COGNAC	ROVERE SAHARA	ROVERE GREY	ROVERE MIELE	ROVERE DARK	ROVERE BIANCO										
ROVERE CHERRY	ROVERE NERO														
		LAMINATO MATERICO TEXTURED LAMINATE	<table border="1"> <tr> <td>CALCE</td> <td>CEMENTO</td> <td>CEMENTO BIANCO</td> <td>CEMENTO VISONE</td> <td>CEMENTO DARK</td> </tr> </table>	CALCE	CEMENTO	CEMENTO BIANCO	CEMENTO VISONE	CEMENTO DARK							
CALCE	CEMENTO	CEMENTO BIANCO	CEMENTO VISONE	CEMENTO DARK											
		TERMO STRUTTURATO THERMO STRUCTURED	<table border="1"> <tr> <td>LARICE BROWN</td> <td>LARICE SABBIA</td> <td>NOCE EUCALIPTO</td> <td>ROVERE SOLE</td> </tr> </table>	LARICE BROWN	LARICE SABBIA	NOCE EUCALIPTO	ROVERE SOLE								
LARICE BROWN	LARICE SABBIA	NOCE EUCALIPTO	ROVERE SOLE												
	④ Inserto Insert	IMPIALLACCIATO VENEERED	<table border="1"> <tr> <td>ROVERE COGNAC</td> <td>ROVERE SAHARA</td> <td>ROVERE GREY</td> <td>ROVERE MIELE</td> <td>ROVERE DARK</td> <td>ROVERE BIANCO</td> </tr> <tr> <td>ROVERE CHERRY</td> <td>ROVERE NERO</td> <td></td> <td></td> <td></td> <td></td> </tr> </table>	ROVERE COGNAC	ROVERE SAHARA	ROVERE GREY	ROVERE MIELE	ROVERE DARK	ROVERE BIANCO	ROVERE CHERRY	ROVERE NERO				
ROVERE COGNAC	ROVERE SAHARA	ROVERE GREY	ROVERE MIELE	ROVERE DARK	ROVERE BIANCO										
ROVERE CHERRY	ROVERE NERO														

ELEMENTI PALO ALTO, libreria

PALO ALTO ELEMENTS, bibliography

LIBRERIA H. 125/128 - 126/129 - 127/130 - 127,8/130,8 SOPRA PIANI DI ISOLA E PENSIOLA
BIBLIOGRAPHY H. 125/128 - 126/129 - 127/130 - 127,8/130,8 ABOVE WORKTOPS OF ISLAND AND PENSIOLA

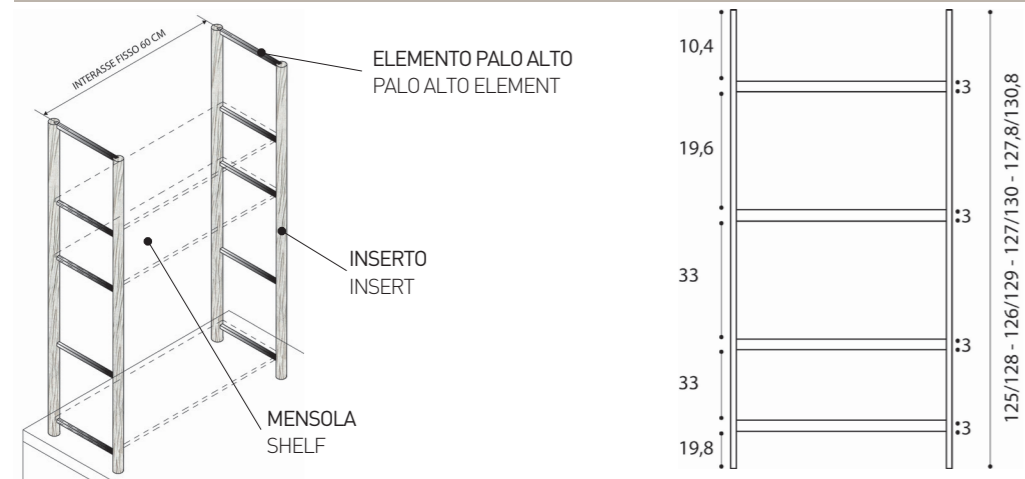

ARTICOLO ARTICLE	DESCRIZIONE DESCRIPTION	DIMENSIONI (cm) DIMENSIONS (cm)	CODICE CODE
---------------------	----------------------------	------------------------------------	----------------

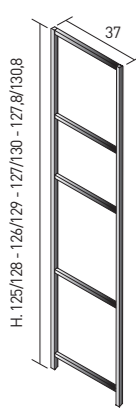

ELEMENTO "PALO ALTO"
"PALO ALTO" ELEMENT

sopra top sp. 4 cm
above wortop th. 4 cm
sopra top sp. 3 cm
above wortop th. 3 cm
sopra top sp. 2 cm
above wortop th. 2 cm
sopra top sp. 1,2 cm
above wortop th. 1,2 cm

H.125/128 x Pr.37	BP00M23
H.126/129 x Pr.37	BP00M22
H.127/130 x Pr.37	BP00M21
H.127,8/130,8 x Pr.37	BP00M20

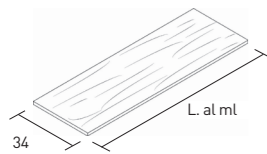

MENSOLA SP. 3 CM
(lunghezza max. 270 cm)
SHELF TH. 3 CM
(length max. 270 cm)

L. at ml MV3B000

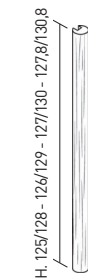

MAGGIORAZIONE PER INSERTO Ø 4 CM
SURCHARGES FOR INSERT Ø 4 CM

H. 125/128	-
H. 126/129	-
H. 127/130	-
H. 127,8/130,8	-

ATTENZIONE!

La libreria Palo Alto deve essere necessariamente appoggiata o fissata ad una parete adiacente.
Non può essere posizionata liberamente a centro stanza senza avere nessun appoggio.

ATTENTION!

The Palo Alto bibliography must necessarily be supported or attached to an adjacent wall.
It can not be positioned freely in the middle of the room without having any support.

ALLUMINIO ALUMINIUM	LAMINATO MATERICO TEXTURED LAMINATE	FENIX FENIX	TERMO STRUTTURATO THERMO STRUCTURED	IMPIALLACCIATO VENEERED
182	-	-	-	-
182	-	-	-	-
182	-	-	-	-
182	-	-	-	-
-	100	179	105	145
-	-	-	-	116
-	-	-	-	117
-	-	-	-	118
-	-	-	-	118

ELEMENTI PALO ALTO, libreria

PALO ALTO ELEMENTS, bibliography

LIBRERIA H.218 ISOLA E PENISOLA
BIBLIOGRAPHY H. 218 WALL ISLAND AND PENINSULA

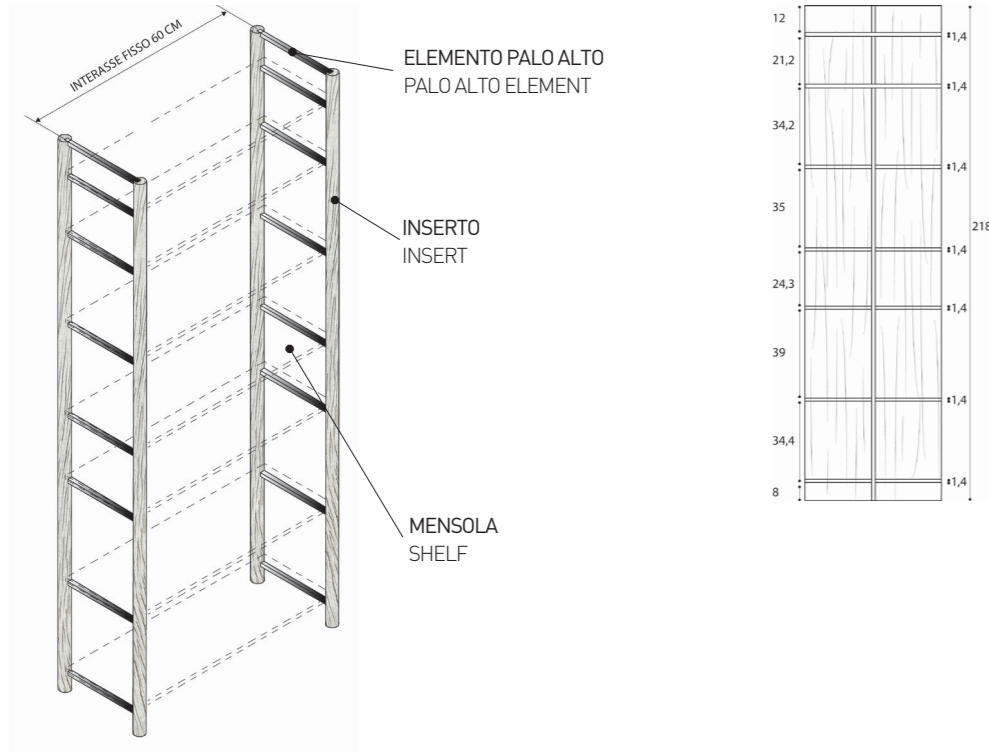

ARTICOLO ARTICLE	DESCRIZIONE DESCRIPTION	DIMENSIONI (cm) DIMENSIONS (cm)	CODICE CODE
	ELEMENTO "PALO ALTO" "PALO ALTO" ELEMENT	H.218 x Pr.37	BP00M24

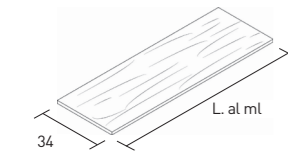

MENSOLA SP. 3 CM
(lunghezza max. 270 cm)
SHELF TH. 3 CM
(length max. 270 cm)

L. at ml MV3B000



MAGGIORAZIONE PER INSERTO Ø 4 CM
SURCHARGES FOR INSERT Ø 4 CM

H. 218 -

ATTENZIONE!

La libreria Palo Alto deve essere necessariamente appoggiata o fissata ad una parete adiacente. Non può essere posizionata liberamente a centro stanza senza avere nessun appoggio.

ATTENTION!

The Palo Alto bibliography must necessarily be supported or attached to an adjacent wall. It can not be positioned freely in the middle of the room without having any support.

ALLUMINIO ALUMINIUM	LAMINATO MATERICO TEXTURED LAMINATE	FENIX FENIX	TERMO STRUTTURATO THERMO STRUCTURED	IMPIALLACCIATO VENEERED
332	-	-	-	-
-	100	179	105	145
-	-	-	-	184

ELEMENTO "JOY SYSTEM"

"JOY SYSTEM" ELEMENT

NEW

SCHEMA COMPOSIZIONE
COMPOSITION LAYOUT

① ②
TRAFILA JOY,
PIATTINA TERMINALE
JOY DIE,
TERMINAL PLATE

③
PANNELLO
PANEL

④
ACCESSORI
ACCESSORIES

Elemento JOY SYSTEM composto da:

- ① **TRAFILA JOY** (vedi finiture nella pagina seguente)
- ② **PIATTINA TERMINALE** (vedi finiture nella pagina seguente)
- ③ **PANNELLO** (vedi finiture nella pagina seguente)
- ④ **ACCESSORI** (Sommare come optional i prezzi degli accessori)

JOY SYSTEM element comprising:

- ① **JOY DIE** (see finishes on next page)
- ② **TERMINAL PLATE** (see finishes on next page)
- ③ **PANEL** (see finishes on next page)
- ④ **ACCESSORIES** (Add the prices of the accessories as optionals)

ARTICOLO ARTICLE	DESCRIZIONE DESCRIZIONE	TIPOLOGIA MATERIALE TYPE OF MATERIAL	COLORI COLOURS
②	Trafila Joy, Piattina Terminale laterale Joy Die, Terminal plate lateral	ALLUMINIO ALUMINIUM	NERO OPACO TITANIO
③	Pannello Panel	FENIX FENIX	GRIGIO LONDRA GRIGIO EFESO NERO INGO GRIGIO BROMO BIANCO KOS BEIGE ARIZONA GRIGIO ANTRIM ROSSO JAIPUR VERDE COMODORO CASTORO OTTAWA CACAO ORINOCO BLUFES
		LAMINATO MATERICO TEXTURED LAMINATE	CALCE CEMENTO CEMENTO BIANCO CEMENTO VISONE CEMENTO DARK PIASENTINA SCURA NERO MARQUINIA GRAFITE BROWN
		TERMOSTRUTTURATO THERMO STRUCTURED	LARICE BROWN LARICE SABBIA ROVERE NODATO ROVERE NATURA NOCE EUCALIPTO ROVERE SOLE
④	Accessori Accessories	METALLO METAL	NERO OPACO TITANIO

ELEMENTO "JOY SYSTEM", posizionato tra base e pensile

"JOY SYSTEM" ELEMENT, between base unit and wall unit

ARTICOLO ARTICLE	DESCRIZIONE DESCRIPTION	SP.(cm) TH. (cm)	DIMENSIONI DIMENSIONS	CODICE CODE
	1 TRAFILA "JOY", lunghezza max 590 cm Predisposto per il fissaggio degli accessori "JOY" DIE, max length 590 cm Prepared for fixing accessories	1,8	ml	BJ00S00
	2 PIATTINA TERMINALE LATERALE A VISTA Altezza variabile a richiesta da H. 51 cm a H. 60 cm "JOY" DIE, max length 590 cm Prepared for fixing accessories		N° 2	BJ00S01
	3 PANNELLO BIFACCIALE (Faccia esterna, Faccia interna e bordi in tutti i colori delle ante) DOUBLE-FACE PANEL (Outside, inside and edges available with all door colours)	1,8	mq	BJ00P00

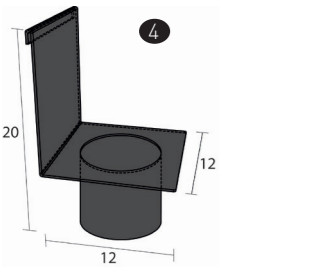
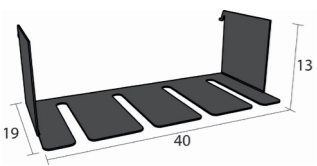
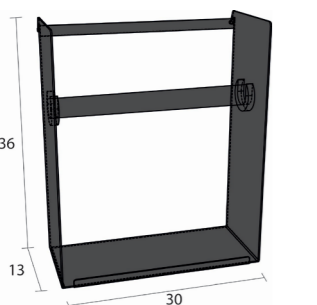
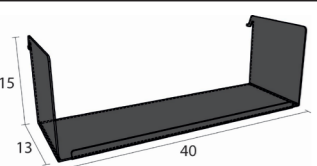
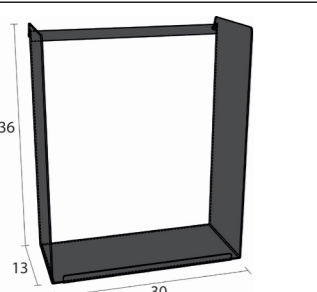

ARTICOLO ARTICLE	DESCRIZIONE DESCRIPTION	L.(cm) W.(cm)	H.(cm) H.(cm)	PR.(cm) D.(cm)	CODICE CODE	NERO OPACO - TITANIO
	4 PORTA MESTOLI IN METALLO METAL LADLE HOLDER	12	20	12	BJ01A00	45
	4 PORTA CALICI IN METALLO METAL GLASS HOLDER	40	13	19	BJ40A00	120
	4 PORTA ROTOLO IN METALLO ROLL HOLDER IN METAL	30	36	13	BJ30A02	145
	4 MENSOLA BASSA IN METALLO LOW METAL SHELF	40	15	13	BJ40A02	56
	4 MENSOLA ALTA IN METALLO HIGH METAL SHELF	30	36	13	BJ30A00	82



Non possibile posizionare dietro al Piano Cottura un pannello in PET e LACCATO
It is not possible to position panel behind the hob a PET and LACQUERED



SP. 1,8 CM: Minimo fatturabile per dimensioni inferiori a 0,25 MQ per tutte le finiture
SP. 1.8 CM: Minimum invoice for dimensions smaller than 0.25 MQ for all finishes

NERO OPACO - TITANIO NERO OPACO - TITANIO	TERMO STRUTTURATO THERMO TEXTURED	LAMINATO MATERICO TEXTURED LAMINATE	FENIX FENIX
20	--	--	--
54	--	--	--
--	189	162	264

	TERMO STRUTTURATO THERMO TEXTURED	LAMINATO MATERICO TEXTURED LAMINATE	FENIX FENIX
L. max			
L. max (cm)	170	120	120
H. max (cm)	270	275	300
venatura pannelli panels grain pattern	verticale vertical	verticale vertical	NO VENATURA NO GRAIN PATTERN

Dimensioni riferire alla massima Altezza e Larghezza dei pannelli

Dimensions refer to the maximum height and width of the panels

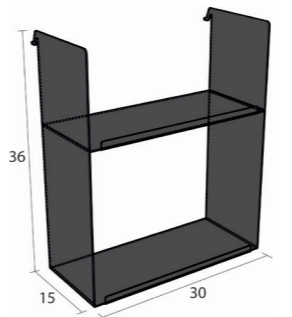
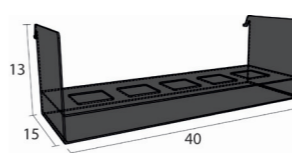
ARTICOLO ARTICLE	DESCRIZIONE DESCRIPTION	L.(cm) W.(cm)	H.(cm) H.(cm)	PR.(cm) D.(cm)	CODICE CODE	NERO OPACO - TITANIO
	4 MENSOLA DOPPIA ALTA IN METALLO DOUBLE HIGH METAL SHELF	30	36	15	BJ30A01	109
	4 PORTA SPEZIE IN METALLO, con n° 5 barattoli METAL SPICE HOLDER, WITH 5 JARS	40	13	15	BJ40A01	117

ELEMENTO COMBO LINE, posizionato tra base e pensile

COMBO LINE ELEMENT, positioned between base cabinet and wall unit

TIPO 1
TYPE 1SCHEMA COMPOSIZIONE ELEMENTO COMBO LINE
COMBO LINE ELEMENT COMPOSITION LAYOUT**- Spalla Alluminio di altezza variabile:**

- da H.53 a H.55,8 cm
- da H.56 a H.58,8 cm

- Pannello schienale di altezza variabile come la Spalla

- Legno sp. 1,8 cm
- Vetro sp. 1,8 cm (luminoso)

- Mensola posizionata fissa in due tipologie:

- Alluminio sp. 1 cm (semplice o luminosa con Led)
- Legno sp.1,8 cm

- Ringhierina fissa in Alluminio**- Possibilità di inserire Accessori OPTIONAL:**

- per mensola Alluminio già esiste la predisposizione per il fissaggio degli accessori.
- per mensola Legno è prevista una barra oggettistica da applicare alla mensola legno con la predisposizione per il fissaggio degli accessori.

- Aluminium side of variable height:

- Wood th. 1,8 cm
- Glass th. 1,8 cm (bright)

- Back panel of variable height, as side

- from H.53 to H.55,8 cm (simple or bright with Led)
- from H.56 to H.58,8 cm

- Fixed shelf in two types:

- Aluminum th. 1 cm
- Wood th. 1,8 cm

- Fixed aluminium rail:

- for the aluminum shelf there is already a predisposition for fixing accessories.
- for Wood shelf there is a gift bar from apply to the wood shelf with the predisposition for fixing accessories.

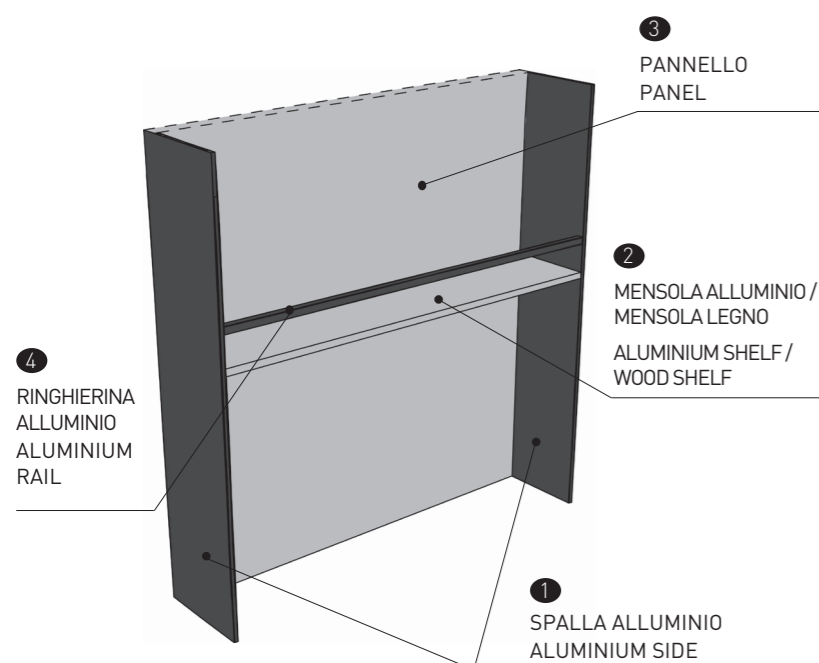

Elemento COMBO LINE (Tipo 1) composto da:

- 1 4 **SPALLA - RINGHIERINA Alluminio** (vedi finiture nella pagina seguente)
- 2 **MENSOLA Alluminio (semplice o luminosa con Led) - MENSOLA Legno** (vedi finiture nella pagina seguente)
- 3 **PANNELLO Legno - PANNELLO Vetro luminoso** (vedi finiture nella pagina seguente)

COMBO LINE element (type 1) comprising:

- 1 4 **Aluminium SIDE - RAIL** (see finishes on next page)
- 2 **Aluminium SHELF (simple or bright with Led) - wood SHELF** (see finishes on next page)
- 3 **Wood PANEL - Glass bright PANEL** (see finishes on next page)

COME SI COMPONE IL PREZZO :

Il prezzo si compone scegliendo la tipologia di elemento COMBO LINE (esempio "tipo 1").

Fare attenzione alla versione dell'elemento "Combo Line" versione con mensola Legno o alla versione con mensola Alluminio. Sommare come optional i prezzi degli accessori.

HOW THE PRICE IS MADE UP:

The price is obtained by selecting the type of COMBO LINE element (e.g. "type 1").

Take care in the case of the "Combo Line" element version with the wood shelf or aluminium shelf.

Add the prices of the accessories as optionals.

ELEMENTO COMBO LINE, in appoggio al top

COMBO LINE ELEMENT, resting on worktop

TIPO 2
TYPE 2SCHEMA COMPOSIZIONE ELEMENTO COMBO LINE
COMBO LINE ELEMENT COMPOSITION LAYOUT**- Spalla Alluminio di altezza variabile:**

- da H.125 a H.156 cm con

- Pannello schienale di altezza variabile come la Spalla

- Legno sp. 1,8 cm
- Vetro sp. 1,8 cm (luminoso)

- Max n° 4 Mensole posizionate liberamente in due tipologie:

- Alluminio sp. 1 cm (semplice o luminosa con Led)
- Legno sp.1,8 cm

- Possibilità di inserire Accessori OPTIONAL:

- per mensola Alluminio già esiste la predisposizione per il fissaggio degli accessori.
- per mensola Legno è prevista una barra oggettistica da applicare alla mensola legno con la predisposizione per il fissaggio degli accessori.

- Aluminium side of variable height:

- from H.125 to H.156 cm

- Back panel of variable height, as side

- Wood th. 1,8 cm
- Glass th. 1,8 cm (bright)

- Max 4 shelves, freely positioned, in two types:

- Aluminum th. 1 cm (simple or bright with Led)
- Wood th. 1,8 cm

- Possibility of adding OPTIONAL accessories:

- for the aluminum shelf there is already a predisposition for fixing accessories.
- for Wood shelf there is a gift bar from apply to the wood shelf with the predisposition for fixing accessories.

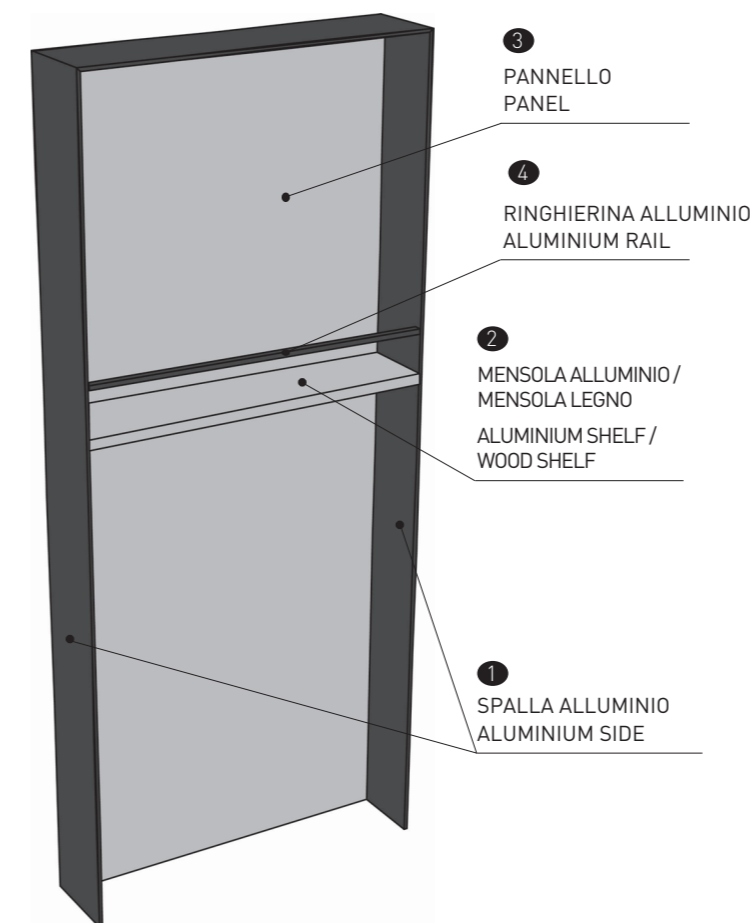

Elemento COMBO LINE (Tipo 2) composto da:

- 1 4 **SPALLA - RINGHIERINA Alluminio** (vedi finiture nella pagina seguente)
- 2 **MENSOLA Alluminio semplice o luminosa con Led) - MENSOLA Legno** (vedi finiture nella pagina seguente)
- 3 **PANNELLO Legno - PANNELLO Vetro luminoso** (vedi finiture nella pagina seguente)

COMBO LINE element (type 2) comprising:

- 1 4 **Aluminium SIDE - RAIL** (see finishes on next page)
- 2 **Aluminium SHELF (simple or bright with Led) - wood SHELF** (see finishes on next page)
- 3 **Wood PANEL - Glass bright PANEL** (see finishes on next page)

COME SI COMPONE IL PREZZO :

Il prezzo si compone scegliendo la tipologia di elemento COMBO LINE (esempio "tipo 2").

Fare attenzione alla versione dell'elemento "Combo Line" versione con mensola Legno o alla versione con mensola Alluminio. Sommare come optional i prezzi degli accessori.

HOW THE PRICE IS MADE UP:

The price is obtained by selecting the type of COMBO LINE element (e.g. "type 2").

Take care in the case of the "Combo Line" element version with the wood shelf or aluminium shelf.

Add the prices of the accessories as optionals.

ELEMENTO COMBO LINE, sospeso a parete

COMBO LINE ELEMENT, mounted on wall

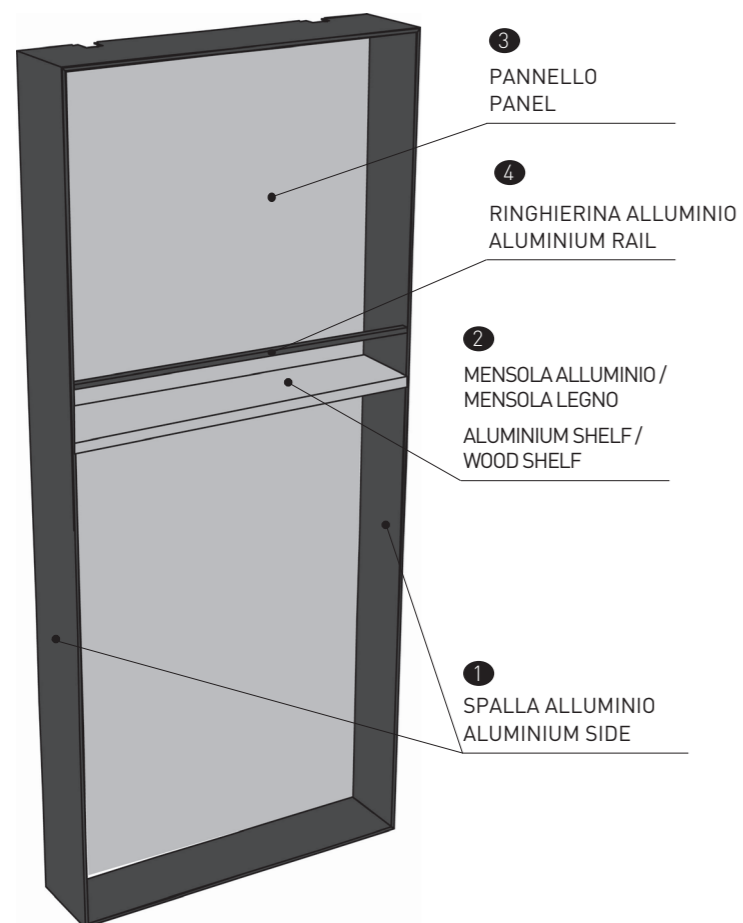
TIPO 3
TYPE 3SCHEMA COMPOSIZIONE ELEMENTO COMBO LINE
COMBO LINE ELEMENT COMPOSITION LAYOUT

- **Spalla Alluminio di altezza variabile:**
 - da H.125 a H.156 cm con
- **Pannello schienale di altezza variabile come la Spalla**
 - Legno sp. 1,8 cm
- **Max n° 4 Mensole posizionate liberamente in due tipologie:**
 - Alluminio sp. 1 cm (semplice o luminosa con Led)
 - Legno sp.1,8 cm
- **Possibilità di inserire Accessori OPTIONAL:**
 - per mensola Alluminio già esiste la predisposizione per il fissaggio degli accessori.
 - per mensola Legno è prevista una barra oggettistica da applicare alla mensola legno con la predisposizione per il fissaggio degli accessori.
- **Aluminium side of variable height:**
 - from H.125 to H.156 cm
- **Back panel of variable height, as side**
 - Wood th. 1,8 cm
- **Max 4 shelves, freely positioned, in two types:**
 - Aluminum th. 1 cm (simple or bright with Led)
 - Wood th. 1,8 cm
- **Possibility of adding OPTIONAL accessories:**
 - for the aluminum shelf there is already a predisposition for fixing accessories.
 - for Wood shelf there is a gift bar from apply to the wood shelf with the predisposition for fixing accessories.

Elemento COMBO LINE (Tipo 3) composto da:

- ① ④ **SPALLA - RINGHIERINA Alluminio** (vedi finiture nella pagina seguente)
- ② **MENSOLA Alluminio - MENSOLA Legno** (vedi finiture nella pagina seguente)
- ③ **PANNELLO Legno** (vedi finiture nella pagina seguente)

COMBO LINE element (type 3) comprising:

- ① ④ **Aluminium SIDE - RAIL** (see finishes on next page)
- ② **Aluminium SHELF (simple or bright with Led) - wood SHELF** (see finishes on next page)
- ③ **Wood PANEL** (see finishes on next page)

COME SI COMPONE IL PREZZO :

Il prezzo si compone scegliendo la tipologia di elemento COMBO LINE (esempio "tipo 3").

Fare attenzione alla versione dell'elemento "Combo Line" versione con mensola Legno o alla versione con mensola Alluminio. Sommare come optional i prezzi degli accessori.

HOW THE PRICE IS MADE UP:







The price is obtained by selecting the type of COMBO LINE element (e.g. "type 3").

Take care in the case of the "Combo Line" element version with the wood shelf or aluminium shelf.

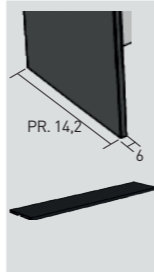
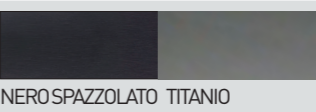
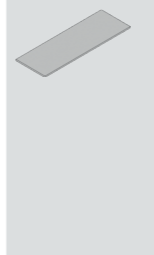
Add the prices of the accessories as optionals.

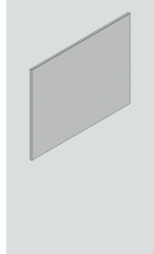
ELEMENTO COMBO LINE, finiture

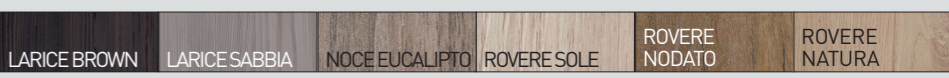
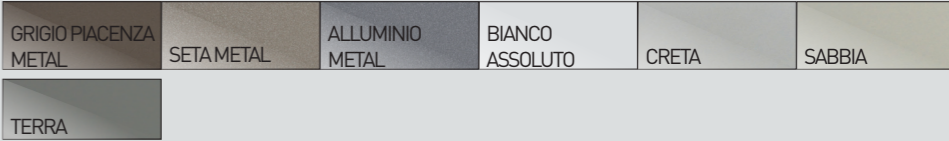
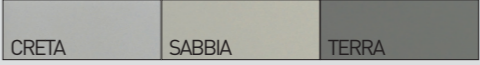
COMBO LINE ELEMENT, finishes

ARTICOLO ARTICLE	DESCRIZIONE DESCRIPTION	TIPOLOGIA MATERIALE TYPE OF MATERIAL	COLORI COLOURS
	① ④ ② Spalla - Ringhierina - Mensola Side - Rail - Shelf	ALLUMINIO ALUMINIUM	
	② Mensola Legno Wood Shelf	FENIX FENIX	
	③ Pannello Schienale Legno Wood Back Panel	LAMINATO MATERICO TEXTURED LAMINATE PET PET	
		TERMO STRUTTURATO THERMO TEXTURED	
		VETRO LUCIDO (di serie) GLASS GLOSSY (standard)	
		VETRO OPACO (di serie) GLASS MATT (standard)	
		VETRO RAL (a richiesta) GLASS RAL (on demand)	

ELEMENTO COMBO LINE, posizionato tra base e pensile (Tipo 1)

COMBO LINE ELEMENT, positioned between base cabinet and wall unit (Type 1)

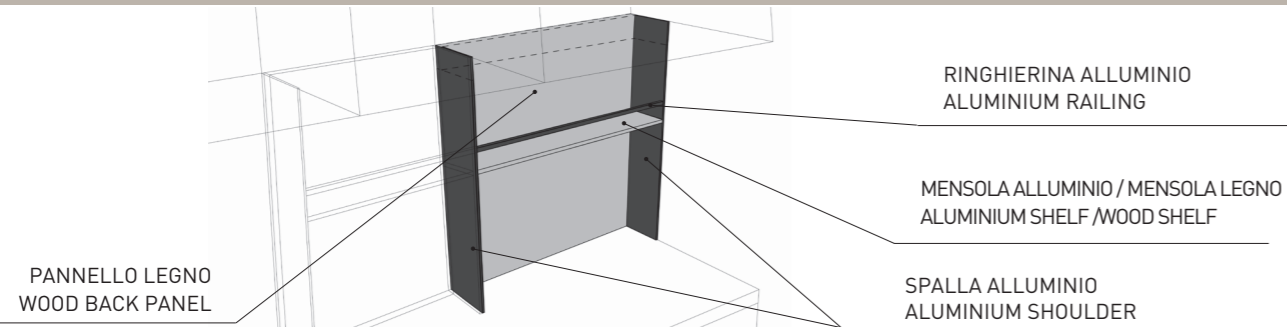
COMBO LINE
COMBO LINE

ARTICOLO ARTICLE	DESCRIZIONE DESCRIPTION	H. (cm) H. (cm)	LARGH. (cm) WIDTH (cm)	CODICE CODE
	ELEMENTO "COMBO LINE"	da H.53 a H.55,8	60	BC60Z00
	• PANNELLO LEGNO	da H.53 a H.55,8	65	BC65Z00
	• MENSOLA ALLUMINIO SP. 1 CM (Predisposta per il fissaggio degli accessori)	da H.53 a H.55,8	75	BC75Z00
	• RINGHIERINA ALLUMINIO	da H.53 a H.55,8	90	BC90Z00
	"COMBO LINE" ELEMENT	da H.53 a H.55,8	120	BC12Z00
	• PANEL WOOD	da H.53 a H.55,8	da 60,1 a 89,9	BC99Z00
	• ALUMINIUM SHELF TH. 1 CM (Prepared for fixing accessories)	da H.53 a H.55,8	da 90,1 a 119,9	BC98Z00
	• ALUMINIUM RAILINGS	da H.56 a H.60	60	BC60Z01
		da H.56 a H.60	65	BC65Z01
		da H.56 a H.60	75	BC75Z01
		da H.56 a H.60	90	BC90Z01
		da H.56 a H.60	120	BC12Z01
	da H.56 a H.60	da 60,1 a 89,9	BC99Z01	
	da H.56 a H.60	da 90,1 a 119,9	BC98Z01	
	ELEMENTO "COMBO LINE"	da H.53 a H.55,8	60	BC60Z00
	• PANNELLO LEGNO	da H.53 a H.55,8	65	BC65Z00
	• MENSOLA ALLUMINIO SP. 1 CM (LUMINOSA) (Predisposta per il fissaggio degli accessori)	da H.53 a H.55,8	75	BC75Z00
	• RINGHIERINA ALLUMINIO	da H.53 a H.55,8	90	BC90Z00
	"COMBO LINE" ELEMENT	da H.53 a H.55,8	120	BC12Z00
	• PANEL WOOD	da H.53 a H.55,8	da 60,1 a 89,9	BC99Z00
	• ALUMINIUM SHELF TH. 1 CM (BRIGHT) (Prepared for fixing accessories)	da H.53 a H.55,8	da 90,1 a 119,9	BC98Z00
	• ALUMINIUM RAILINGS	da H.56 a H.60	60	BC60Z01
		da H.56 a H.60	65	BC65Z01
		da H.56 a H.60	75	BC75Z01
		da H.56 a H.60	90	BC90Z01
		da H.56 a H.60	120	BC12Z01
	da H.56 a H.60	da 60,1 a 89,9	BC99Z01	
	da H.56 a H.60	da 90,1 a 119,9	BC98Z01	
	ELEMENTO "COMBO LINE" PANNELLO	da H.53 a H.55,8	60	BC60Z00
	• PANNELLO LEGNO	da H.53 a H.55,8	65	BC65Z00
	• MENSOLA LEGNO SP. 1,8 CM LEGNO	da H.53 a H.55,8	75	BC75Z00
	• RINGHIERINA ALLUMINIO	da H.53 a H.55,8	90	BC90Z00
	"COMBO LINE" ELEMENT	da H.53 a H.55,8	da 60,1 a 89,9	BC99Z00
	• PANEL LEGNO	da H.56 a H.60	60	BC60Z01
	• WOOD SHELF TH. 1,8 CM WOOD	da H.56 a H.60	65	BC65Z01
	• ALUMINIUM RAILING	da H.56 a H.60	75	BC75Z01
		da H.56 a H.60	90	BC90Z01
		da H.56 a H.60	120	BC12Z01
		da H.56 a H.60	da 60,1 a 89,9	BC99Z01
		da H.56 a H.60	da 90,1 a 119,9	BC98Z01



COMBO LINE Larghezza 120 cm disponibile solo con mensola ALLUMINIO.
COMBO LINE Width 120 cm available only with ALUMINIUM shelf.



COMBO LINE posizionato dietro al piano cottura necessita di Pannello e Mensola in Alluminio, non possibile Pannello e Mensola in legno.
COMBO LINE, positioned behind the hob, requires aluminium panel and shelf, not compatible with wood panel and shelf.

"Combo Line" - finitura NERO SPAZZOLATO o TITANIO
"Combo Line" - NERO SPAZZOLATO or TITANIO finish

LAMINATO MATERICO TEXTURED LAMINATE	FENIX FENIX	TERMO STRUTTURATO THERMO STRUCTURED	PET PET
228	289	227	241
233	300	233	248
241	318	241	258
263	356	263	283
299	422	298	325
284	376	284	304
368	491	367	394
233	298	232	247
238	308	237	353
258	341	258	276
269	366	268	290
304	434	303	332
287	386	286	308
376	509	376	404
344	405	343	357
348	415	348	363
352	429	352	369
384	477	384	404
420	543	419	446
425	555	424	453
458	581	457	484
349	414	348	363
353	423	352	368
369	452	369	387
390	487	389	411
425	555	424	453
413	512	412	434
466	599	466	494
183	258	182	199
186	267	186	204
184	277	183	204
202	315	202	226
212	331	212	238
188	267	187	205
191	275	190	209
201	300	200	222
208	325	207	233
215	341	214	242

ELEMENTO COMBO LINE, posizionato tra base e pensile (Tipo 1)

COMBO LINE ELEMENT, between base unit and wall unit (Type 1)

COMBO LINE
COMBO LINE

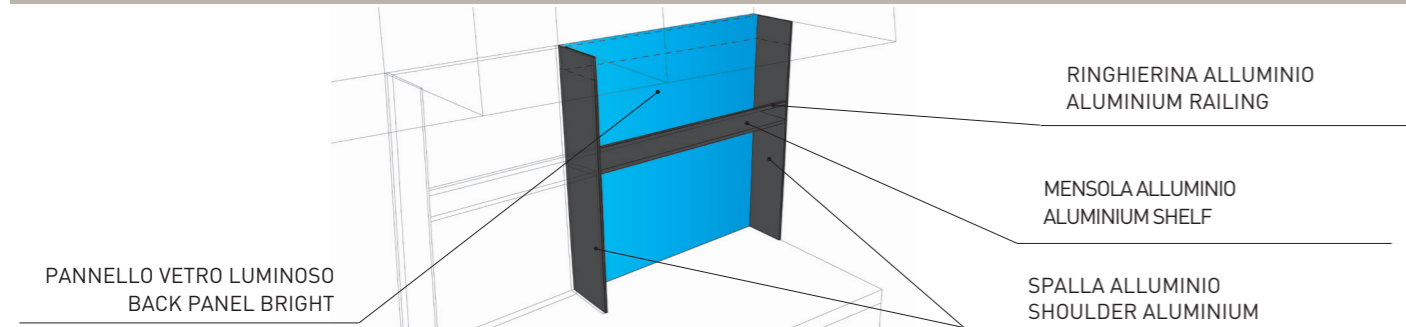

ARTICOLO ARTICLE	DESCRIZIONE DESCRIPTION	H. (cm) H. (cm)	LARGH. (cm) WIDTH (cm)	CODICE CODE
	ELEMENTO "COMBO LINE"	da H.53 a H.55,8	60	BC60Z00
	• PANNELLO VETRO (LUMINOSO)	da H.53 a H.55,8	65	BC65Z00
	• MENSOLA ALLUMINIO SP. 1 CM (Predisposta per il fissaggio degli accessori)	da H.53 a H.55,8	75	BC75Z00
	• RINGHIERINA ALLUMINIO	da H.53 a H.55,8	90	BC90Z00
	"COMBO LINE" ELEMENT	da H.53 a H.55,8	120	BC12Z00
	• PANEL GLASS (BRIGHT)	da H.53 a H.55,8	da 60,1 a 89,9	BC99Z00
	• ALUMINIUM SHELF TH. 1 CM (Prepared for fixing accessories)	da H.53 a H.55,8	da 90,1 a 119,9	BC98Z00
	• ALUMINIUM RAILINGS			

da H.56 a H.60	60	BC60Z01
da H.56 a H.60	65	BC65Z01
da H.56 a H.60	75	BC75Z01
da H.56 a H.60	90	BC90Z01
da H.56 a H.60	120	BC12Z01
da H.56 a H.60	da 60,1 a 89,9	BC99Z01
da H.56 a H.60	da 90,1 a 119,9	BC98Z01

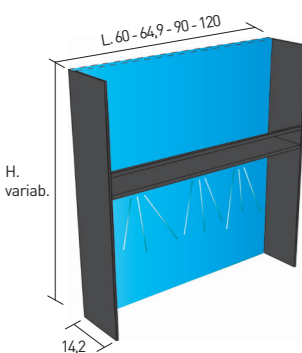

ELEMENTO "COMBO LINE"	da H.53 a H.55,8	60	BC60Z00
• PANNELLO VETRO (LUMINOSO)	da H.53 a H.55,8	65	BC65Z00
• MENSOLA ALLUMINIO SP. 1 CM (LUMINOSA) (Predisposta per il fissaggio degli accessori)	da H.53 a H.55,8	75	BC75Z00
• RINGHIERINA ALLUMINIO	da H.53 a H.55,8	90	BC90Z00
"COMBO LINE" ELEMENT	da H.53 a H.55,8	120	BC12Z00
• PANEL GLASS (BRIGHT)	da H.53 a H.55,8	da 60,1 a 89,9	BC99Z00
• ALUMINIUM SHELF TH. 1 CM (BRIGHT) (Prepared for fixing accessories)	da H.53 a H.55,8	da 90,1 a 119,9	BC98Z00
• ALUMINIUM RAILINGS			

da H.56 a H.60	60	BC60Z01
da H.56 a H.60	65	BC65Z01
da H.56 a H.60	75	BC75Z01
da H.56 a H.60	90	BC90Z01
da H.56 a H.60	120	BC12Z01
da H.56 a H.60	da 60,1 a 89,9	BC99Z01
da H.56 a H.60	da 90,1 a 119,9	BC98Z01



COMBO LINE Larghezza 120 cm disponibile solo con mensola ALLUMINIO.
COMBO LINE Width 120 cm available only with ALUMINIUM shelf.



COMBO LINE posizionato dietro al piano cottura necessita di Pannello e Mensola in Alluminio, non possibile Pannello e Mensola in legno.
COMBO LINE positioned dietro to the hob requires Aluminum Panel and Shelf, not possible panel and wooden shelf.



Si consiglia di abbinare sempre con il pannello vetro luminoso la mensola alluminio luminosa per avere una uniformità di luce sull'elemento COMBO LINE
It is recommended to always combine the luminous aluminum shelf with the luminous glass panel to have a uniform light on the COMBO LINE element





"Combo Line" - finitura NERO SPAZZOLATO o TITANIO

"Combo Line" - NERO SPAZZOALTO or TITANIO finish

VETRO LUCIDO (di serie) GLASS GLOSSY (standard)	VETRO OPACO (di serie) GLASS MATT (standard)	VETRO RAL (a richiesta) GLASS RAL (on demand)
455	460	514
472	478	536
503	510	577
560	569	649
666	677	784
589	598	686
751	763	881
471	477	534
488	495	557
534	541	613
583	592	678
693	705	820
603	613	706
775	788	912
571	576	630
587	593	651
614	621	688
681	690	770
787	798	905
715	724	812
841	853	971
587	593	650
603	610	672
645	652	724
704	713	799
814	826	941
729	739	832
865	878	1002

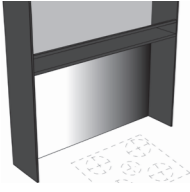
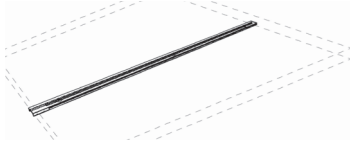
ELEMENTO COMBO LINE, posizionato tra base e pensile (Tipo 1)

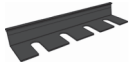
COMBO LINE ELEMENT, positioned between base cabinet and wall unit (Type 1)

ARTICOLO ARTICLE	DESCRIZIONE DESCRIPTION	H. (cm) H. (cm)	LARGH. (cm) WIDTH (cm)	CODICE CODE
	PANNELLO SCHIENALE ACCIAIO RETRO COTTURA Elemento da inserire obbligatoriamente retro piano cottura STEEL BACK PANEL HOB BACK element to be compulsorily inserted back of the hob	H.35	58,7	BC60A01
		H.35	73,7	BC75A01
		H.35	88,7	BC90A01
		H.35	118,7	BC12A01
	BARRA OGGETTISTICA , Da applicare sotto la mensola Legno per permettere di fissare gli accessori UTENSIL BAR For fitting under the wood shelf to permit fixing of accessories		58,75	BC60A00
			63,75	BC65A00
			73,75	BC75A00
			88,75	BC90A00
			da 58,8 a 88,6	BC99A00
	KIT 3 GANCI KIT OF 3 HOOKS			BC00A00
	PORTA ROTOLO PAPER ROLL HOLDER			BC00A01
	PORTA CALICI WINE GLASS RACK			BC00A02
	TELECOMANDO PER PANNELLO E MENSOLA LUMINOSA REMOTE CONTROL FOR PANEL AND LUMINOUS SHELF			200TOM0012



BARRA OGGETTISTICA,
Da applicare sotto la mensola Legno
per permettere di fissare gli accessori
UTENSIL BAR
For fitting under the wood shelf
to permit fixing of accessories

KIT 3 GANCI
KIT OF 3 HOOKS

PORTA ROTOLO
PAPER ROLL HOLDER

PORTA CALICI
WINE GLASS RACK



TELECOMANDO PER PANNELLO E MENSOLA LUMINOSA
REMOTE CONTROL FOR PANEL AND LUMINOUS SHELF



Per inserire questo accessorio considerare un'altezza minima tra una mensola e l'altra di 30 cm
A minimum height of 30 cm is needed between one shelf and the next to fit this accessory



Non possibile inserire nel pannello vetro luminoso
It is not possible to insert into the luminous glass panel

ACCIAIO STEEL	NERO SPAZZOLATO NERO SPAZZOLATO	TITANIO TITANIO
219	-	-
255	-	-
258	-	-
289	-	-
-	13	13
-	16	16
-	18	18
-	19	19
-	22	22
-	12	12
-	29	29
-	32	32
136	136	136

ELEMENTO COMBO LINE, in appoggio al top (Tipo 2)

COMBO LINE ELEMENT, resting on worktop (Type 2)

COMBO LINE
COMBO LINE

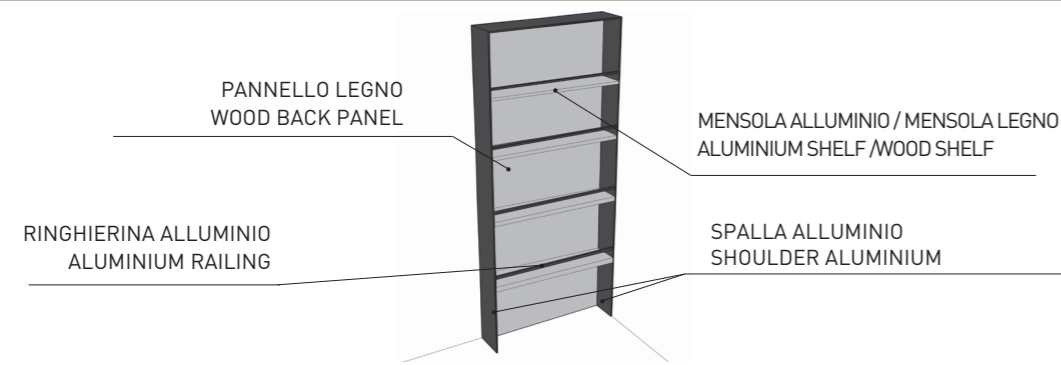

ARTICOLO ARTICLE	DESCRIZIONE DESCRIPTION	H. (cm) H. (cm)	LARGH. (cm) WIDTH (cm)	CODICE CODE
	ELEMENTO "COMBO LINE" + PANNELLO LEGNO "COMBO LINE" ELEMENT + PANEL WOOD	da H.60 a H.96	45	BC45Z06
		da H.60 a H.96	60	BC60Z06
		da H.60 a H.96	65	BC65Z06
		da H.60 a H.96	75	BC75Z06
		da H.60 a H.96	da 60,1 a 80	BC99Z06
		da H.96,1 a H.126	45	BC45Z07
		da H.96,1 a H.126	60	BC60Z07
		da H.96,1 a H.126	65	BC65Z07
		da H.96,1 a H.126	75	BC75Z07
		da H.96,1 a H.126	da 60,1 a 80	BC99Z07
		da H.126,1 a H.140	45	BC45Z02
		da H.126,1 a H.140	60	BC60Z02
		da H.126,1 a H.140	65	BC65Z02
		da H.126,1 a H.140	75	BC75Z02
		da H.126,1 a H.140	da 60,1 a 80	BC99Z02
		da H.140,1 a H.156	45	BC45Z03
		da H.140,1 a H.156	60	BC60Z03
		da H.140,1 a H.156	65	BC65Z03
		da H.140,1 a H.156	75	BC75Z03
		da H.140,1 a H.156	da 60,1 a 80	BC99Z03



ARTICOLO ARTICLE	DESCRIZIONE DESCRIPTION	H. (cm) H. (cm)	LARGH. (cm) WIDTH (cm)	CODICE CODE
	MENSOLA LEGNO SP. 1,8 CM E RINGHIERINA ALLUMINIO WOOD SHELF TH. 1,8 CM AND ALUMINIUM RAILING	SP. 1,8	43,75	BC45M03
		SP. 1,8	58,75	BC60M03
		SP. 1,8	63,75	BC65M03
		SP. 1,8	73,75	BC75M03
		SP. 1,8	da 58,8 a 88,6	BC99M03

ARTICOLO ARTICLE	DESCRIZIONE DESCRIPTION	H. (cm) H. (cm)	LARGH. (cm) WIDTH (cm)	CODICE CODE
	MENSOLA E RINGHIERINA ALLUMINIO SP. 1 CM Predisposta per il fissaggio degli accessori ALUMINIUM SHELF AND RAILING TH. 1 CM, Prepared for fixing accessories	SP. 1	43,75	BC45M02
		SP. 1	58,75	BC60M02
		SP. 1	63,75	BC65M02
		SP. 1	73,75	BC75M02
		SP. 1	da 58,8 a 88,6	BC99M02

ARTICOLO ARTICLE	DESCRIZIONE DESCRIPTION	H. (cm) H. (cm)	LARGH. (cm) WIDTH (cm)	CODICE CODE
	MENSOLA LUMINOSA E RINGHIERINA ALLUMINIO SP. 1 CM Predisposta per il fissaggio degli accessori ALUMINIUM SHELF BRIGHT AND RAILING TH. 1 CM, Prepared for fixing accessories	SP. 1	43,75	BC45M06
		SP. 1	58,75	BC60M06
		SP. 1	63,75	BC65M06
		SP. 1	73,75	BC75M06
		SP. 1	da 58,8 a 88,6	BC99M06



COMBO LINE Larghezza 120 cm disponibile solo con mensola ALLUMINIO.
COMBO LINE Width 120 cm available only with ALUMINIUM shelf.



Possibilità di inserire e posizionare a libera scelta le mensole per un max di n° 4.
Up to max. 4 shelves can be added and freely positioned as required.

"Combo Line" - finitura NERO SPAZZOLATO o TITANIO

"Combo Line" - NERO SPAZZOLATO or TITANIO finish

LAMINATO MATERICO TEXTURED LAMINATE	FENIX FENIX	TERMO STRUTTURATO THERMO STRUCTURED	PET PET
306	386	306	323
320	426	320	343
324	439	324	349
354	486	353	382
386	527	385	416
336	440	335	358
352	491	351	381
357	507	356	389
390	563	389	427
426	610	425	464
365	481	364	390
383	538	382	416
394	561	393	430
425	617	423	465
463	669	462	507
370	499	369	397
390	562	389	427
401	588	400	441
433	647	432	478
472	701	471	521

15	29	15	18
16	30	16	19
18	32	18	21
20	36	19	23
27	54	27	33

NERO SPAZZOLATO NERO SPAZZOLATO	TITANIO TITANIO
59	59
63	63
67	67
77	77
99	99

177	177
179	179
182	182
190	190
225	225

ELEMENTO COMBO LINE, in appoggio al top (Tipo 2)

COMBO LINE ELEMENT, resting on the worktop [Type 2]

COMBO LINE
COMBO LINE



ARTICOLO ARTICLE	DESCRIZIONE DESCRIPTION	H. (cm) H. (cm)	LARGH. (cm) WIDTH (cm)	CODICE CODE
	ELEMENTO "COMBO LINE" + PANNELLO VETRO LUMINOSO "COMBO LINE" ELEMENT + PANEL GLASS BRIGHT	da H.60 a H.96	45	BC45Z06
		da H.60 a H.96	60	BC60Z06
		da H.60 a H.96	65	BC65Z06
		da H.60 a H.96	75	BC75Z06
		da H.60 a H.96	da 60,1 a 80	BC99Z06
		da H.96,1 a H.126	45	BC45Z07
		da H.96,1 a H.126	60	BC60Z07
		da H.96,1 a H.126	65	BC65Z07
		da H.96,1 a H.126	75	BC75Z07
		da H.96,1 a H.126	da 60,1 a 80	BC99Z07
		da H.126,1 a H.140	45	BC45Z02
		da H.126,1 a H.140	60	BC60Z02
		da H.126,1 a H.140	65	BC65Z02
		da H.126,1 a H.140	75	BC75Z02
		da H.126,1 a H.140	da 60,1 a 80	BC99Z02
		da H.140,1 a H.156	45	BC45Z03
		da H.140,1 a H.156	60	BC60Z03
		da H.140,1 a H.156	65	BC65Z03
		da H.140,1 a H.156	75	BC75Z03
		da H.140,1 a H.156	da 60,1 a 80	BC99Z03



ARTICOLO ARTICLE	DESCRIZIONE DESCRIPTION	H. (cm) H. (cm)	LARGH. (cm) WIDTH (cm)	CODICE CODE
	MENSOLA E RINGHIERINA ALLUMINIO SP. 1 CM Predisposta per il fissaggio degli accessori ALUMINIUM SHELF AND RAILING TH. 1 CM, Prepared for fixing accessories	SP. 1	43,75	BC45M02
		SP. 1	58,75	BC60M02
		SP. 1	63,75	BC65M02
		SP. 1	73,75	BC75M02
		SP. 1	da 58,8 a 88,6	BC99M02
	MENSOLA LUMINOSA E RINGHIERINA ALLUMINIO SP. 1 CM Predisposta per il fissaggio degli accessori ALUMINIUM SHELF BRIGHT AND RAILING TH. 1 CM, Prepared for fixing accessories	SP. 1	43,75	BC45M06
		SP. 1	58,75	BC60M06
		SP. 1	63,75	BC65M06
		SP. 1	73,75	BC75M06
		SP. 1	da 58,8 a 88,6	BC99M06



COMBO LINE Larghezza 120 cm disponibile solo con mensola ALLUMINIO.
COMBO LINE Width 120 cm available only with ALUMINIUM shelf.



Possibilità di inserire e posizionare a libera scelta le mensole per un max di n° 4.
Possibility of inserting and position of free choice the shelves for a maximum of n° 4.



Si consiglia di abbinare sempre con il pannello vetro luminoso la mensola alluminio luminosa per avere una uniformità di luce sull'elemento COMBO LINE
It is recommended to always combine the luminous aluminum shelf with the luminous glass panel to have a uniform light on the COMBO LINE element

"Combo Line" - finitura NERO SPAZZOLATO o TITANIO





"Combo Line" - NERO SPAZZOALTO or TITANIO finish

VETRO LUCIDO (di serie) GLASS GLOSSY (standard)	VETRO OPACO (di serie) GLASS MATT (standard)	VETRO RAL (a richiesta) GLASS RAL (on demand)
574	581	650
648	658	750
672	683	782
743	755	870
843	858	996
660	669	760
755	768	888
786	800	930
874	890	1041
998	1017	1198
715	726	827
822	836	970
786	876	1021
951	969	1136
1097	1109	1310
751	762	874
869	884	1034
912	929	1090
1010	1029	1216
1158	1181	1405

NERO SPAZZOLATO NERO SPAZZOLATO	TITANIO TITANIO
59	59
63	63
67	67
77	77
99	99
177	177
179	179
182	182
190	190
225	225

ELEMENTO COMBO LINE, in appoggio al top (Tipo 2)

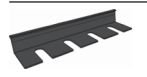
COMBO LINE ELEMENT, resting on the worktop [Type 2]

ARTICOLO ARTICLE	DESCRIZIONE DESCRIPTION	H. (cm) H. (cm)	LARGH. (cm) WIDTH (cm)	CODICE CODE
	BARRA OGGETTISTICA , Da applicare sotto la mensola Legno per permettere di fissare gli accessori OBJECTIVE BAR, To be applied under the Wood shelf to allow the accessor to be fixed		43,75	BC45A00
			58,75	BC60A00
			63,75	BC65A00
			73,75	BC75A00
			da 58,8 a 88,6	BC99A00
	KIT 3 GANCI KIT 3 HOOKS			BC00A00
	PORTA ROTOLO ROLL HOLDER			BC00A01
	PORTA CALICI DOOR GLASSES			BC00A02
	TELECOMANDO PER PANNELLO E MENSOLA LUMINOSA REMOTE CONTROL FOR PANEL AND LUMINOUS SHELF			100TOM0012
				

NERO SPAZZOLATO NERO SPAZZOLATO	TITANIO TITANIO
11	11
13	13
16	16
18	18
22	22
12	12
29	29
32	32
136	136



Per inserire questo accessorio considerare un'altezza minima tra una mensola e l'altra di 30 cm
To insert this accessory consider a height between one shelf and another of 30 cm

ELEMENTO COMBO LINE, sospeso a parete (Tipo 3)

COMBO LINE ELEMENT, mounted on wall (Type 3)

COMBO LINE
COMBO LINE

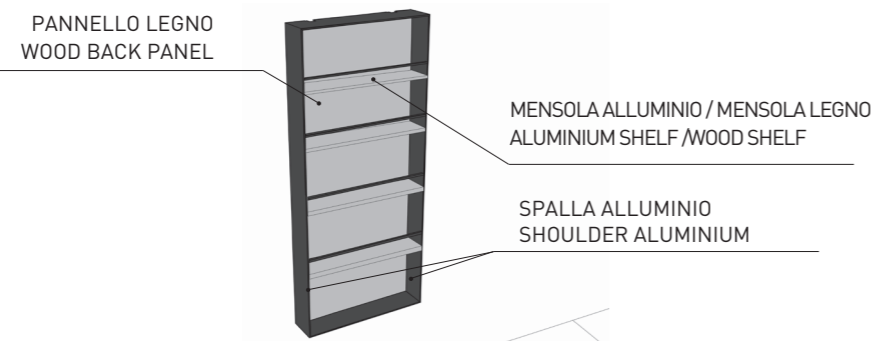

ARTICOLO ARTICLE	DESCRIZIONE DESCRIPTION	H. (cm) H. (cm)	LARGH. (cm) WIDTH (cm)	CODICE CODE
	ELEMENTO "COMBO LINE" + PANNELLO LEGNO "COMBO LINE" ELEMENT + PANEL WOOD	da H.60 a H.96	45	BC45Z08
		da H.60 a H.96	60	BC60Z08
		da H.60 a H.96	65	BC65Z08
		da H.60 a H.96	75	BC75Z08
		da H.60 a H.96	da 60,1 a 80	BC99Z08
		da H.96,1 a H.126	45	BC45Z09
		da H.96,1 a H.126	60	BC60Z09
		da H.96,1 a H.126	65	BC65Z09
		da H.96,1 a H.126	75	BC75Z09
		da H.96,1 a H.126	da 60,1 a 80	BC99Z09
		da H.126,1 a H.140	45	BC45Z04
		da H.126,1 a H.140	60	BC60Z04
		da H.126,1 a H.140	65	BC65Z04
		da H.126,1 a H.140	75	BC75Z04
		da H.126,1 a H.140	da 60,1 a 80	BC99Z04
		da H.140,1 a H.156	45	BC45Z05
		da H.140,1 a H.156	60	BC60Z05
		da H.140,1 a H.156	65	BC65Z05
		da H.140,1 a H.156	75	BC75Z05
		da H.140,1 a H.156	da 60,1 a 80	BC99Z05

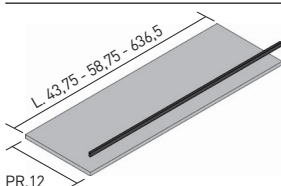

MENSOLA LEGNO SP. 1,8 CM E RINGHIERINA ALLUMINIO
WOOD SHELF TH. 1,8 CM AND ALUMINIUM RAILING

H. (cm) H. (cm)	LARGH. (cm) WIDTH (cm)	CODICE CODE
SP. 1,8	43,75	BC45M03
SP. 1,8	58,75	BC60M03
SP. 1,8	63,75	BC65M03
SP. 1,8	75	BC75M03
SP. 1,8	da 58,8 a 88,6	BC99M03

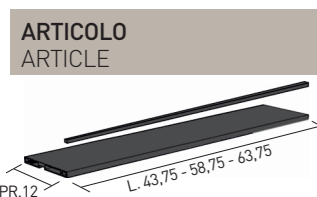

MENSOLA E RINGHIERINA ALLUMINIO SP. 1 CM
Predisposta per il fissaggio degli accessori

ALUMINIUM SHELF AND RAIL TH. 1 CM
Provision for fixing accessories

H. (cm) H. (cm)	LARGH. (cm) WIDTH (cm)	CODICE CODE
SP. 1	43,75	BC45M02
SP. 1	58,75	BC60M02
SP. 1	63,75	BC65M02
SP. 1	73,75	BC75M02
SP. 1	da 58,8 a 88,6	BC99M02

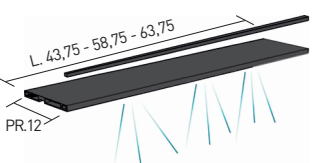

MENSOLA LUMINOSA E RINGHIERINA ALLUMINIO SP. 1 CM
Predisposta per il fissaggio degli accessori

ALUMINIUM SHELF BRIGHT AND RAILING TH. 1 CM,
Prepared for fixing accessories

H. (cm) H. (cm)	LARGH. (cm) WIDTH (cm)	CODICE CODE
SP. 1	43,75	BC45M06
SP. 1	58,75	BC60M06
SP. 1	63,75	BC65M06
SP. 1	73,75	BC75M06
SP. 1	da 58,8 a 88,6	BC99M06



COMBO LINE Larghezza 120 cm disponibile solo con mensola ALLUMINIO.
COMBO LINE Width 120 cm available only with ALUMINIUM shelf.



Possibilità di inserire e posizionare a libera scelta le mensole per un max di n° 4.
Up to max. 4 shelves can be added and freely positioned as required.

"Combo Line" - finitura NERO SPAZZOLATO o TITANIO

"Combo Line" - NERO SPAZZOLATO or TITANIO finish

LAMINATO MATERICO TEXTURED LAMINATE	FENIX FENIX	TERMO STRUTTURATO THERMO STRUCTURED	PET PET
291	371	291	308
314	420	314	337
319	434	319	344
348	480	347	376
382	523	381	412
321	425	320	343
346	485	345	375
352	502	351	384
381	554	380	418
419	603	418	458
350	466	349	375
376	531	375	409
383	550	382	419
418	610	416	458
459	665	458	503
355	484	354	382
383	555	382	420
390	577	389	430
426	640	425	471
468	697	467	517
15	29	15	18
16	30	16	19
18	32	18	21
20	36	19	23
27	54	27	33

NERO SPAZZOLATO
NERO SPAZZOLATO

TITANIO
TITANIO

59

59

63

63

67

67

77

77

99

99

177

177

179

179

182

182

190





190

225

225

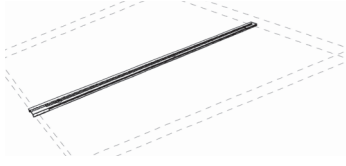
ELEMENTO COMBO LINE, sospeso a parete (Tipo 3)

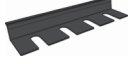
COMBO LINE ELEMENT, mounted on wall (Type 3)

ARTICOLO ARTICLE	DESCRIZIONE DESCRIPTION	H. (cm) H. (cm)	LARGH. (cm) WIDTH (cm)	CODICE CODE
	BARRA OGGETTISTICA Da applicare sotto la mensola Legno per permettere di fissare gli accessori UTENSIL BAR For fitting under the wood shelf to permit fixing of accessories		43,75	BC45A00
			58,75	BC60A00
			63,75	BC65A00
			73,75	BC75A00
			da 58,8 a 88,6	BC99A00
	KIT 3 GANCI KIT OF 3 HOOKS			BC00A00
	PORTA ROTOLO PAPER ROLL HOLDER			BC00A01
	PORTA CALICI WINE GLASS RACK 			BC00A02
	TELECOMANDO PER MENSOLA LUMINOSA REMOTE CONTROL FOR SHELF LUMINOUS			200TOM0012

NERO SPAZZOLATO NERO SPAZZOLATO	TITANIO TITANIO
11	11
13	13
16	16
18	18
22	22
12	12
29	29
32	32
136	136



Per inserire questo accessorio considerare un'altezza minima tra una mensola e l'altra di 30 cm
A minimum height of 30 cm is needed between one shelf and the next to fit this accessory

MANIGLIA LINEAR

LINEAR HANDLE

TIPOLOGIA MATERIALE TYPE OF MATERIAL	COLORI COLOURS
---	-------------------

ALLUMINIO verniciato
Painted ALUMINIUM

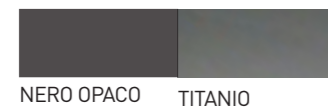

NERO OPACO TITANIO

Colori in pronta consegna
Available colours



ATTENZIONE !

LA MANIGLIA "LINEAR" È DISPONIBILE SOLO SU BASI CON MODULO H.81 CM IN POSIZIONE ORIZZONTALE, PERTANTO NON È POSSIBILE L'INSERIMENTO SU BASI CON MODULO H. 78 CM.

ATTENTION !

THE "LINEAR" HANDLE IS AVAILABLE ONLY ON BASES WITH A H.81 CM MODULE IN A HORIZONTAL POSITION, THEREFORE IT IS NOT POSSIBLE TO INSERT IT ON BASES WITH A MODULE H. 78 CM.

RISPETTARE OBBLIGATORIAMENTE LE REGOLE DI POSIZIONAMENTO DELLE MANIGLIE.
IN CASO CONTRARIO VERRANNO FORNITE LE MANIGLIE SENZA LAVORAZIONI DI FORATURA SUI FRONTALI.
IT IS MANDATORY TO COMPLY WITH THE HANDLE POSITIONING RULES, OTHERWISE,
HANDLES WILL BE SUPPLIED WITHOUT ANY DRILLING ON THE FRONTS

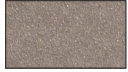
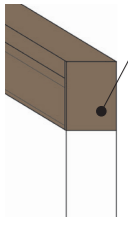
MANIGLIA HANDLE	INGOMBRO IN PROF. (mm) OVERALL DIMENSIONS IN PROF. (mm)	POSIZIONE POSITION	REGOLE POSIZIONAMENTO (RIFERITE ALLA LARGHEZZA E ALTEZZA DEL FONTELE) POSITIONING RULES (REFERRING TO THE WIDTH AND HEIGHT OF THE FRONT)
MRUF MRUG  TITANIO	23	Orizz. Centrale/Vert. laterale Horiz. Central/vertical side	Per anta fino a 597 mm For door up to 597 mm
			Per anta tra 598 e 957 mm For doors between 598 and 957
			Per anta tra 958 e 1557 mm For doors between 958 and 1557
			Per anta maggiore o uguale a 1558 mm For doors longer than or equal to 1558 mm
			Per fasce tamponamento For filler
			Per gola angolo 56 X 56 For corner groove 56 X 56

MANIGLIA LINEAR

LINEAR HANDLE

TIPOLOGIA MANIGLIA TYPE OF HANDLE



MAGGIORAZIONE
SURCHARGE

METROPOLIS

+ 20

+ 28

+ 35

+ 46



+ 20

+ 46

MANIGLIA LINEAR

LINEAR HANDLE

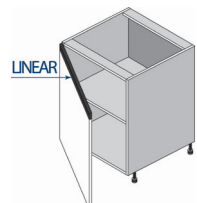
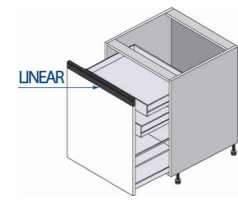
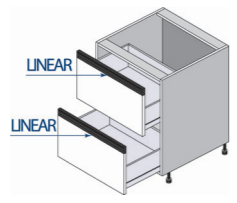
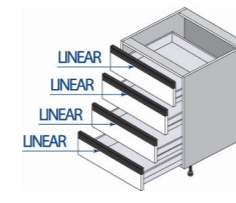
POSIZIONAMENTO MANIGLIA "LINEAR" SULLE VARIE TIPOLOGIE DI BASI H. 81 cm "LINEAR" HANDLE POSITIONING ON THE VARIOUS BASIS TYPES h. 81 cm

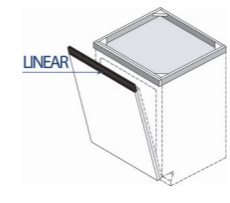
<p>Base con anta Base unit with door</p>  <p>POSIZIONE ORIZZONTALE HORIZONTAL POSITION</p>	<p>Base estraibile Pull-out base unit</p>  <p>POSIZIONE ORIZZONTALE HORIZONTAL POSITION</p>	<p>Base con cesti Base unit deep-pan drawers</p>  <p>POSIZIONE ORIZZONTALE HORIZONTAL POSITION</p>	<p>Base con cassetti Base unit with drawers</p>  <p>POSIZIONE ORIZZONTALE HORIZONTAL POSITION</p>	<p>Base per forno Oven base unit</p>  <p>POSIZIONE ORIZZONTALE HORIZONTAL POSITION</p>	<p>Base per lavastoviglie Dishwasher base unit</p>  <p>POSIZIONE ORIZZONTALE HORIZONTAL POSITION</p>
---	---	--	---	---	--

POSIZIONAMENTO MANIGLIA "LINEAR" SULLE VARIE TIPOLOGIE DI COLONNE H.141 cm "LINEAR" HANDLE POSITIONING ON THE VARIOUS TYPES OF TALL UNITS H.141 cm

<p>Colonna con anta Tall unit with door</p>  <p>POSIZIONE ORIZZONTALE HORIZONTAL POSITION</p>	<p>Colonna forno con anta Tall oven unit with door</p>  <p>POSIZIONE ORIZZONTALE HORIZONTAL POSITION</p>	<p>Colonna forno con estraibile Tall oven unit with pull-out</p>  <p>POSIZIONE ORIZZONTALE HORIZONTAL POSITION</p>	<p>Colonna forno con cesti Tall oven unit with deep-pan drawers</p>  <p>POSIZIONE ORIZZONTALE HORIZONTAL POSITION</p>	<p>Colonna estraibile Tall unit pull-out</p>  <p>POSIZIONE ORIZZONTALE HORIZONTAL POSITION</p>
---	---	---	--	---

Colonna angolo
Cornet tall oven

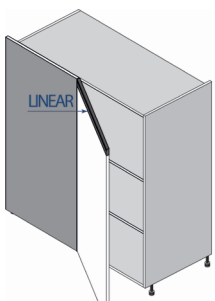

POSIZIONE ORIZZONTALE
HORIZONTAL POSITION

MANIGLIA LINEAR

LINEAR HANDLE

* Non possibile maniglia LINEAR in posizione Verticale per modello NATURAL
LINEAR handle not possible in upright position for NATURAL model

POSIZIONAMENTO MANIGLIA "LINEAR" E "LINEAR A SCOMPARSA" SULLE VARIE TIPOLOGIE DI COLONNE H.210 - 234 cm "LINEAR" HANDLE POSITIONING ON THE VARIOUS TYPES OF TALL UNITS H.210 - 234 cm

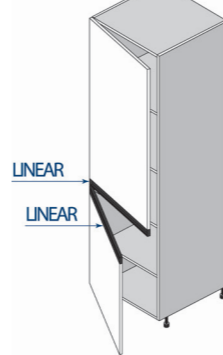
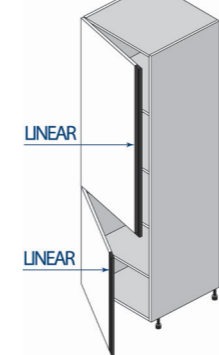
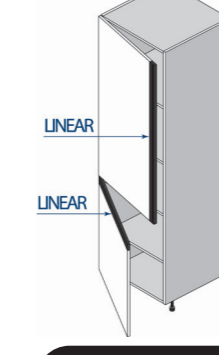
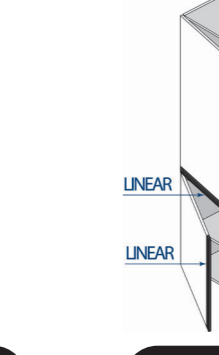
<p>Colonna con ante Tall unit with doors</p>  <p>POSIZIONE ORIZZONTALE HORIZONTAL POSITION</p>	<p>Colonna con ante e cesto Tall unit with door and deep-pan drawer</p>  <p>POSIZIONE VERTICALE UPRIGHT POSITION</p>	<p>Colonna con ante e cesti Tall unit with door and deep-pan drawers</p>  <p>POSIZIONE VERTICALE (anta superiore) POSIZIONE ORIZZONTALE (anta inferiore) UPRIGHT POSITION (upper door) HORIZONTAL POSITION (lower door)</p>	<p>Colonna frigo anta unica Tall fridge unit with single door</p>  <p>POSIZIONE ORIZZONTALE (anta inferiore) POSIZIONE VERTICALE (anta superiore) HORIZONTAL POSITION (lower door) UPRIGHT POSITION (upper door)</p>
--	--	---	--

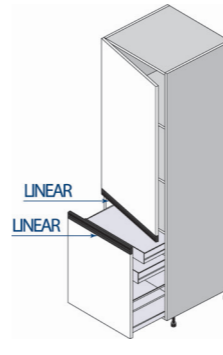
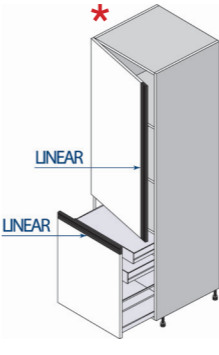
<p>Colonna con ante e cassetti + cesto Tall unit with door and drawers + deep-pan drawers</p>  <p>POSIZIONE ORIZZONTALE HORIZONTAL POSITION</p>	<p>Colonna forno con ante Tall oven unit with doors</p>  <p>POSIZIONE VERTICALE (anta superiore) POSIZIONE ORIZZONTALE (anta inferiore) UPRIGHT POSITION (upper door) HORIZONTAL POSITION (lower door)</p>
--	---

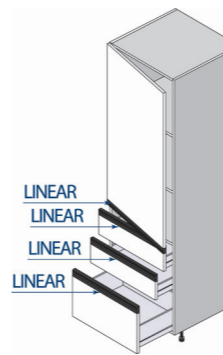
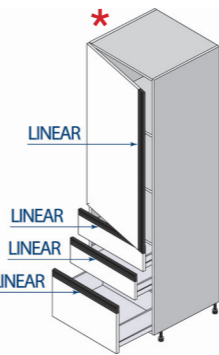
<p>Colonna forno con ante Tall oven unit with doors</p>  <p>POSIZIONE ORIZZONTALE HORIZONTAL POSITION</p>	<p>Colonna forno con ante Tall oven unit with doors</p>  <p>POSIZIONE VERTICALE (anta superiore) POSIZIONE ORIZZONTALE (cassetti e cesto inferiori) UPRIGHT POSITION (upper door) HORIZONTAL POSITION (lower drawers and deep-pan drawers)</p>
---	--

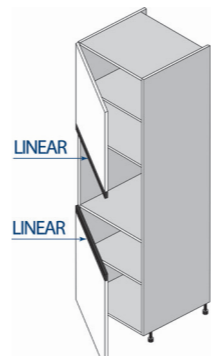
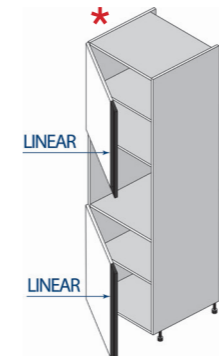
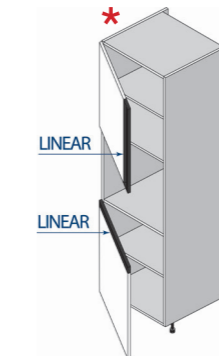
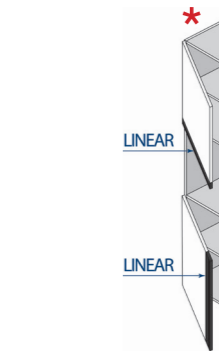
<p>Colonna forno con ante Tall oven unit with doors</p>  <p>POSIZIONE ORIZZONTALE HORIZONTAL POSITION</p>	<p>Colonna forno con ante Tall oven unit with doors</p>  <p>POSIZIONE VERTICALE UPRIGHT POSITION</p>	<p>Colonna forno con ante Tall oven unit with doors</p>  <p>POSIZIONE VERTICALE (anta superiore) POSIZIONE ORIZZONTALE (anta inferiore) UPRIGHT POSITION (upper door) HORIZONTAL POSITION (lower door)</p>	<p>Colonna forno con ante Tall oven unit with doors</p>  <p>POSIZIONE ORIZZONTALE (anta inferiore) POSIZIONE VERTICALE (anta superiore) HORIZONTAL POSITION (lower door) UPRIGHT POSITION (upper door)</p>
---	--	--	--

MANIGLIA LINEAR

LINEAR HANDLE

* Non possibile maniglia LINEAR in posizione Verticale per modello NATURAL
 LINEAR handle not possible in upright position for NATURAL model

POSIZIONAMENTO MANIGLIA "LINEAR" E "LINEAR A SCOMPARSA" SULLE VARIE TIPOLOGIE DI COLONNE H.210 - 234 cm "LINEAR" HANDLE POSITIONING ON THE VARIOUS TYPES OF TALL UNITS H.210 - 234 cm

Colonna forno con anta e cestone
 Tall oven unit with doors and deep-pan drawer

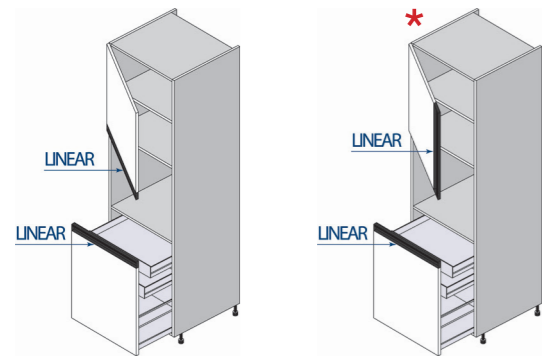

POSIZIONE ORIZZONTALE
 HORIZONTAL POSITION

POSIZIONE VERTICALE (anta superiore)
 POSIZIONE ORIZZONTALE (anta inferiore)
 UPRIGHT POSITION (upper door)
 HORIZONTAL POSITION (lower door)

Colonna forno con anta e cesti
 Tall oven unit with doors and deep-pan drawers

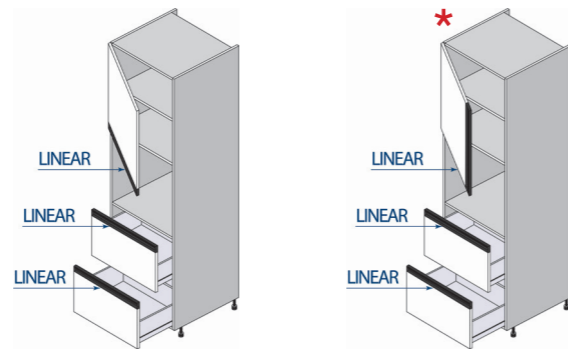

POSIZIONE ORIZZONTALE
 HORIZONTAL POSITION

POSIZIONE VERTICALE (anta superiore)
 POSIZIONE ORIZZONTALE (cesti inferiori)
 UPRIGHT POSITION (upper door)
 HORIZONTAL POSITION (lower deep-pan drawers)

Colonna forno con anta e cassetti
 Tall oven unit with doors and drawers

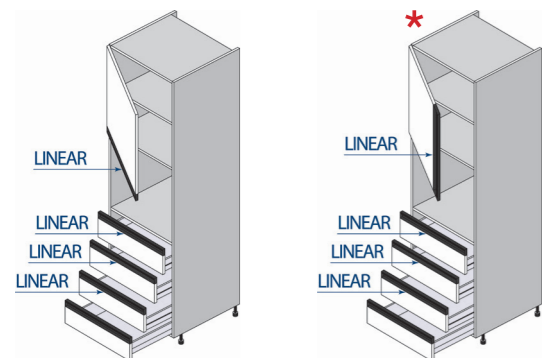

POSIZIONE ORIZZONTALE
 HORIZONTAL POSITION

POSIZIONE VERTICALE (anta superiore)
 POSIZIONE ORIZZONTALE (cassetti inferiori)
 UPRIGHT POSITION (upper door)
 HORIZONTAL POSITION (lower drawers)

Colonna forno con anta e cassetti + cesto
 Tall oven unit with doors and drawer + deep-pan drawer

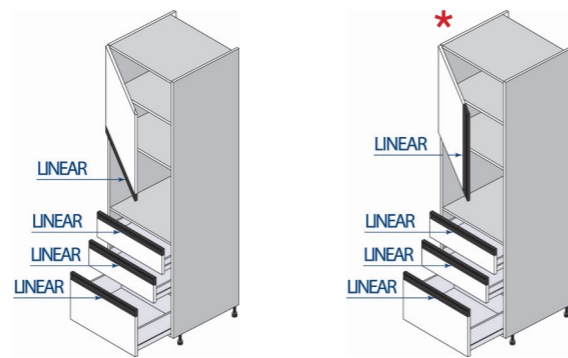

POSIZIONE ORIZZONTALE
 HORIZONTAL POSITION

POSIZIONE VERTICALE (anta superiore)
 POSIZIONE ORIZZONTALE (cassetti e cesto inferiori)
 UPRIGHT POSITION (upper door)
 HORIZONTAL POSITION (lower drawers and deep-pan drawer)

Colonna forno con anta + anta vela e anta
 Tall oven unit with door + door slide and door

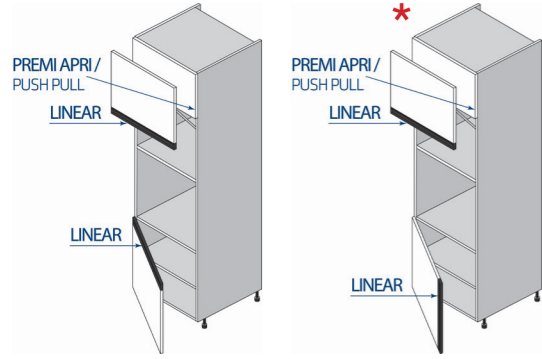

PREMI APRI /
 PUSH PULL

POSIZIONE ORIZZONTALE
 HORIZONTAL POSITION

POSIZIONE ORIZZONTALE (anta inferiore)
 POSIZIONE VERTICALE (anta superiore)
 HORIZONTAL POSITION (lower door)
 UPRIGHT POSITION (upper door)

Colonna forno con anta + anta vela + cesto
 Tall oven unit with door + door slide and door and deep-pan drawer

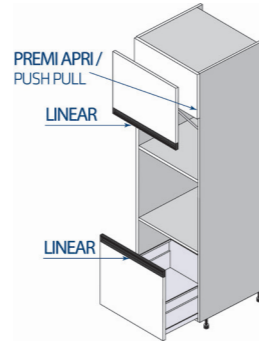

PREMI APRI /
 PUSH PULL

POSIZIONE ORIZZONTALE
 HORIZONTAL POSITION

Colonna forno + microonde con ante
 Oven + Microwave oven Tall unit with doors

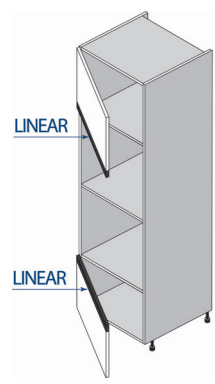

POSIZIONE ORIZZONTALE
 HORIZONTAL POSITION

Colonna forno + microonde con anta e cesto
 Oven + Microwave oven Tall unit with door and deep-pan drawer

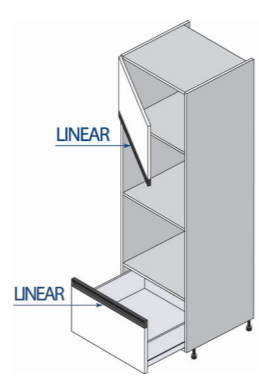

POSIZIONE ORIZZONTALE
 HORIZONTAL POSITION

MANIGLIA LINEAR

LINEAR HANDLE

* Non possibile maniglia LINEAR in posizione Verticale per modello NATURAL
 LINEAR handle not possible in upright position for NATURAL model

POSIZIONAMENTO MANIGLIA "LINEAR" E "LINEAR A SCOMPARSA" SULLE VARIE TIPOLOGIE DI COLONNE H.210 - 234 cm "LINEAR" HANDLE POSITIONING ON THE VARIOUS TYPES OF TALL UNITS H.210 - 234 cm

Colonna con estraibile Total-View
 Pull-out tall unit with Total-View

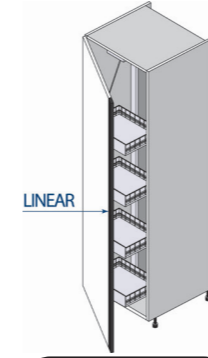

POSIZIONE VERTICALE
 UPRIGHT POSITION

Colonna con estraibile 5 cesti interni
 Pull-out tall unit with 5 deep-pan drawers

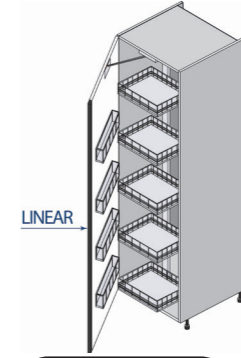

POSIZIONE VERTICALE
 UPRIGHT POSITION

Colonna angolo con ante
 Cornet tall oven with doors

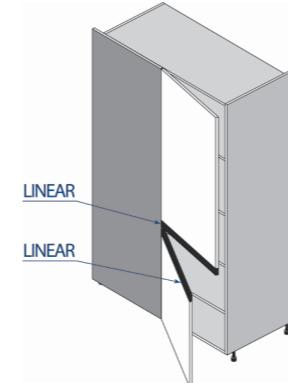

POSIZIONE ORIZZONTALE
 HORIZONTAL POSITION

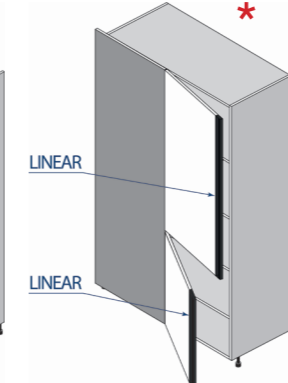

POSIZIONE VERTICALE
 UPRIGHT POSITION

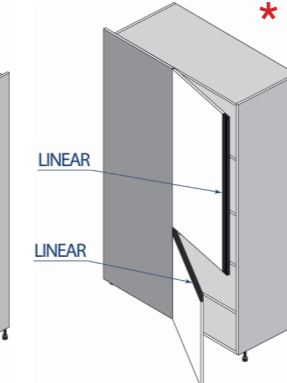

POSIZIONE VERTICALE (anta superiore)
 POSIZIONE ORIZZONTALE (anta inferiore)
 UPRIGHT POSITION (upper door)
 HORIZONTAL POSITION (lower door)

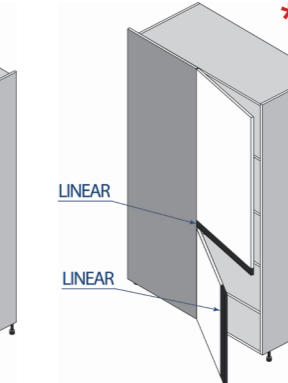

POSIZIONE ORIZZONTALE (anta inferiore)
 POSIZIONE VERTICALE (anta superiore)
 HORIZONTAL POSITION (lower door)
 UPRIGHT POSITION (upper door)

Colonna angolo con anta unica
 Cornet tall oven with single doors

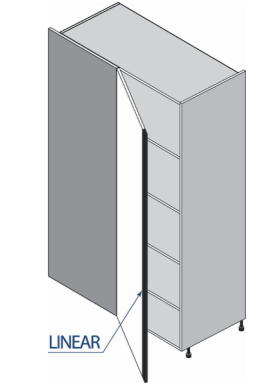

POSIZIONE VERTICALE
 UPRIGHT POSITION

PENSILE CON FONDO PRESA SAGOMATA (DI SERIE) WALL UNIT WITH SHAPED LINEAR BOTTOM (STANDARD)

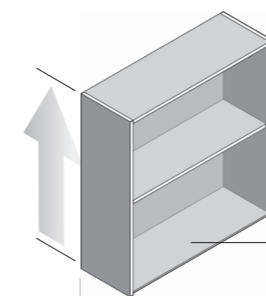

P. 34

Altezze disponibili:
 Available heights:

- H. 36
- H. 48
- H. 60
- H. 72
- H. 96
- H. 132

Fondo presa sagomata
 Shaped LINEAR bottom

ATTENZIONE!

Quando la cucina è con maniglia LINEAR, il pensile viene fornito di serie con fondo presa sagomata, per permettere l'apertura dell'anta senza la maniglia
 ATTENTION!

When the kitchen is with LINEAR handle, the wall unit one is furnished of series with fund shaped taking, to allow the opening of the shutter without the handle

MANIGLIA LINEAR

LINEAR HANDLE

* Non possibile maniglia LINEAR in posizione Verticale per modello NATURAL
 LINEAR handle not possible in upright position for NATURAL model

POSIZIONAMENTO MANIGLIA "LINEAR" NEI SOPRA COLONNE H.36 - 48 cm
 "LINEAR" HANDLE POSITIONING ON THE OVEN TALL UNITS H.36 - 48 cm

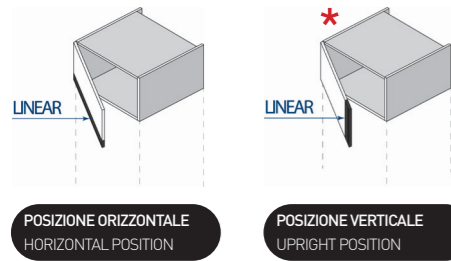
Sopra Colonna 1 anta
 Oven Tall units 1 door

Sopra Colonna Vasistas (L. 75 cm)
 Oven Tall units w/lift-up door (L. 75 cm)

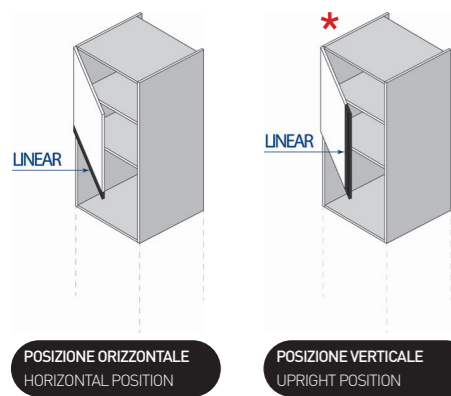
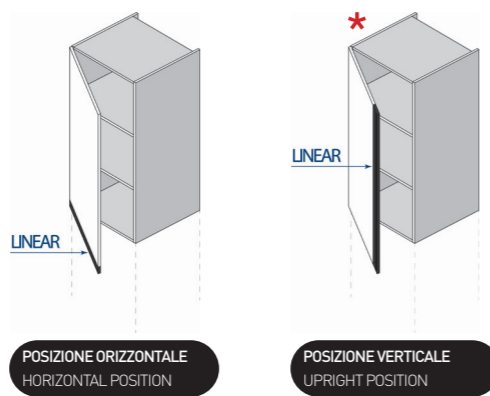
POSIZIONAMENTO MANIGLIA "LINEAR" NELLE COLONNE SOSPESE H.129 - 153 cm
 "LINEAR" HANDLE POSITIONING ON THE SUSPENDED TALL UNITS H.129 - 153 cm

Colonna Sospesa Forno 1 anta
 Suspended Tall Units Oven 1 door

Colonna Sospesa Dispensa 1 anta
 Suspended Tall Units Larder 1 door
**MANIGLIA GRIP**

GRIP HANDLE

TIPOLOGIA MATERIALE
 TYPE OF MATERIAL

COLORI
 COLOURS

ALLUMINIO verniciato
 Painted ALUMINIUM

 Colori in pronta consegna
 Available colours

TIPOLOGIA MANIGLIA
 TYPE OF HANDLE

Mangilia GRIP
a scomparsa

 GRIP Handle
 concealed

Mangilia GRIP

GRIP Handle

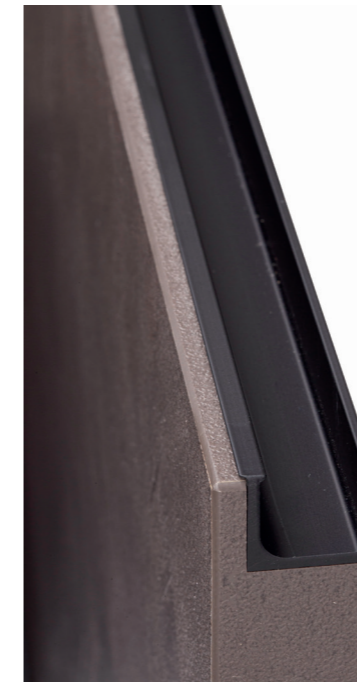
ATTENZIONE !

LA MANIGLIA "GRIP" È DISPONIBILE SOLO SU BASI CON MODULO H.81 CM IN POSIZIONE ORIZZONTALE, PERTANTO NON È POSSIBILE L'INSERIMENTO SU BASI CON MODULO H. 78 CM.

ATTENTION !

THE "GRIP" HANDLE IS AVAILABLE ONLY ON BASES WITH A H.81 CM MODULE IN A HORIZONTAL POSITION, THEREFORE IT IS NOT POSSIBLE TO INSERT IT ON BASES WITH A MODULE H. 78 CM.

MANIGLIA GRIP

GRIP HANDLE

RISPETTARE OBBLIGATORIAMENTE LE REGOLE DI POSIZIONAMENTO DELLE MANIGLIE. IN CASO CONTRARIO VERRANNO FORNITE LE MANIGLIE SENZA LAVORAZIONI DI FORATURA SUI FRONTALI. IT IS MANDATORY TO COMPLY WITH THE HANDLE POSITIONING RULES; OTHERWISE, HANDLES WILL BE SUPPLIED WITHOUT ANY DRILLING ON THE FRONTS.

MANIGLIA HANDLE	INGOMBRO IN PROF. (mm) OVERALL DIMENSIONS IN PROF. (mm)	POSIZIONE POSITION	REGOLE POSIZIONAMENTO (RIFERITE ALLA LARGHEZZA E ALTEZZA DEL FONTALE) POSITIONING RULES (REFERRING TO THE WIDTH AND HEIGHT OF THE FRONT)	MAGGIORAZIONE SURCHARGE
				METROPOLIS - COLOR TREND - NATURAL

MRUH MRUI MRUJ

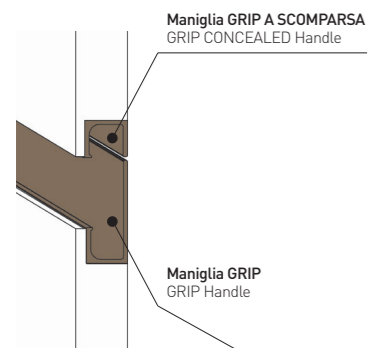

23	Orizz. Centrale/Vert. laterale Horiz. Central/vertical side	Per anta fino a 597 mm For door up to 597 mm	+ 20
		Per anta tra 598 e 1197 mm For doors between 598 and 1197 mm	+ 28
		Per anta tra 1198 e 1377 mm For doors between 1198 and 1377 mm	+ 50
		Per anta tra 1378 e 2097 mm For doors between 1278 and 2097 mm	+ 60
		Per anta tra 2098 e 2277 mm For doors between 2098 and 2277 mm	+ 85
		Per anta maggiore o uguale a 2278 mm For doors longer than or equal to 2278 mm	+ 95
		Per fasce tamponamento For filler	+ 20
23	Orizz. Centrale/Vert. laterale Horiz. Central/vertical side	Per gola angolo 56 X 56 For corner groove 56 X 56	+ 30
		Per anta fino a 597 mm For door up to 597 mm	+ 20
		Per anta tra 598 e 1197 mm For doors between 598 and 1197 mm	+ 28
		Per anta tra 1198 e 1377 mm For doors between 1198 and 1377 mm	+ 50
		Per anta tra 1378 e 2097 mm For doors between 1278 and 2097 mm	+ 60
		Per anta tra 2098 e 2277 mm For doors between 2098 and 2277 mm	+ 85
		Per anta maggiore o uguale a 2278 mm For doors longer than or equal to 2278 mm	+ 95
23	Orizz. Centrale/Vert. laterale Horiz. Central/vertical side	Per fasce tamponamento For filler	+ 20
		Per gola angolo 56 X 56 For corner groove 56 X 56	+ 30

MANIGLIA GRIP

GRIP HANDLE

POSIZIONAMENTO MANIGLIA "GRIP" E "GRIP A SCOMPARSA" SULLE VARIE TIPOLOGIE DI BASI H. 81 cm "GRIP" AND "CONCEALED GRIP" HANDLE POSITIONING ON THE VARIOUS BASIS TYPES h. 81 cm

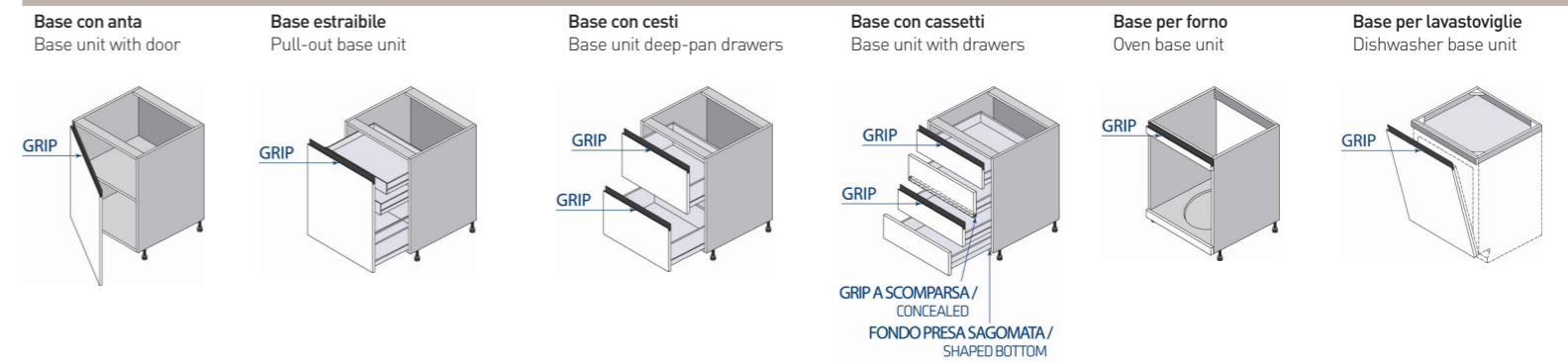

POSIZIONAMENTO MANIGLIA "GRIP" E "GRIP A SCOMPARSA" SULLE VARIE TIPOLOGIE DI COLONNE H.141 cm "GRIP" AND "CONCEALED GRIP" HANDLE POSITIONING ON THE VARIOUS TYPES OF TALL UNITS H.141 cm

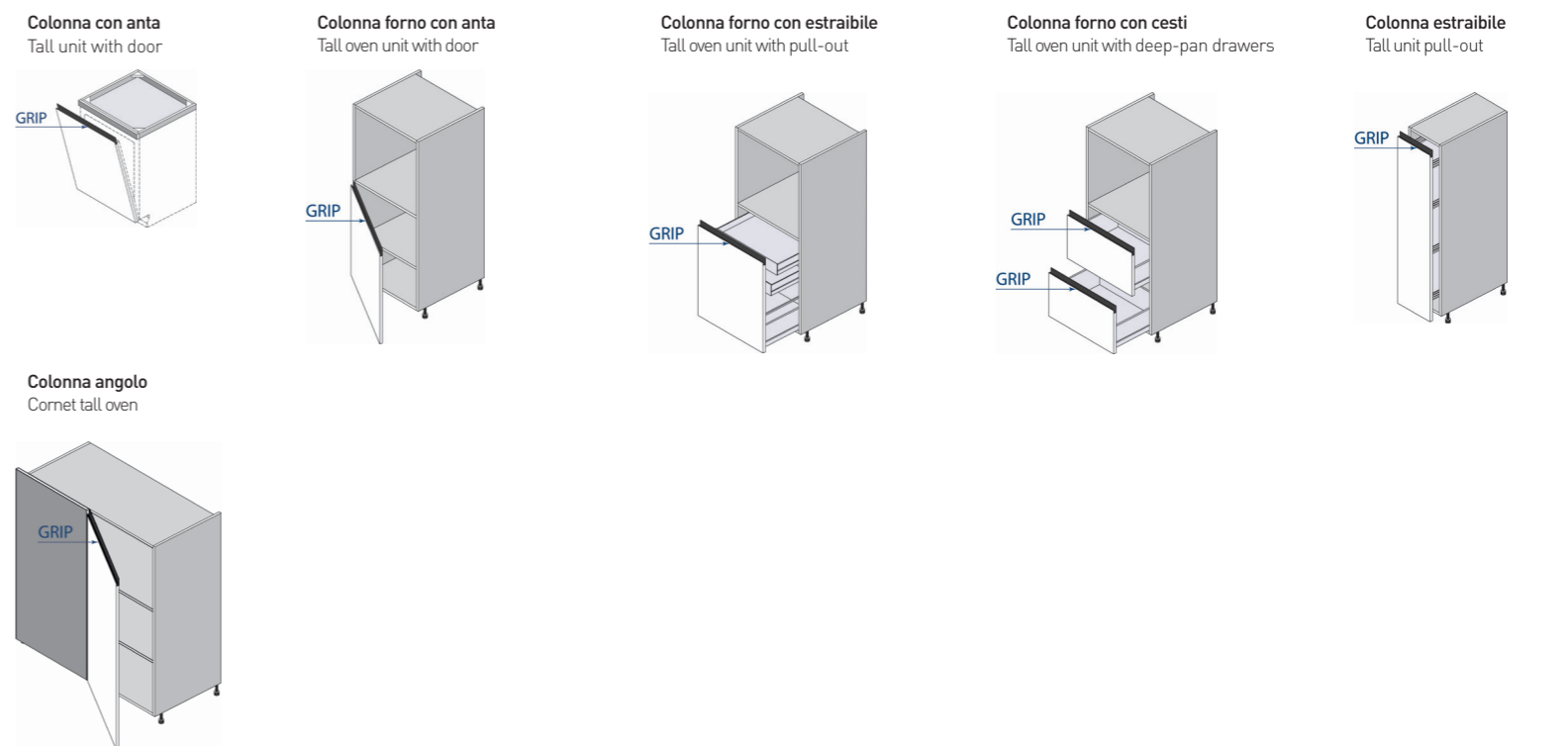

MANIGLIA GRIP

GRIP HANDLE

* Non possibile maniglia GRIP in posizione Verticale per modello NATURAL
GRIP handle not possible in upright position for NATURAL model

POSIZIONAMENTO MANIGLIA "GRIP" E "GRIP A SCOMPARSA" SULLE VARIE TIPOLOGIE DI COLONNE H.210 - 234 cm
"GRIP" AND "GRIP CPNCEALED" HANDLE POSITIONING ON THE VARIOUS TYPES OF TALL UNITS H.210 - 234 cm

Colonna con ante
Tall unit with doors

GRIP
GRIP A SCOMPARSA / CONCEALED
POSIZIONE ORIZZONTALE / HORIZONTAL POSITION
* POSIZIONE VERTICALE / UPRIGHT POSITION
* POSIZIONE VERTICALE / UPRIGHT POSITION
NO
GRIP A SCOMPARSA / CONCEALED

Colonna con ante e cesto
Tall unit with door and deep-pan drawer

Colonna con ante e cesti
Tall unit with door and deep-pan drawers

Colonna con ante e cassetti + cesto
Tall unit with door and drawers + deep-pan drawers

GRIP
POSIZIONE ORIZZONTALE / HORIZONTAL POSITION
GRIP
GRIP A SCOMPARSA / CONCEALED
POSIZIONE ORIZZONTALE / HORIZONTAL POSITION
GRIP
GRIP A SCOMPARSA / CONCEALED
POSIZIONE ORIZZONTALE / HORIZONTAL POSITION

Colonna frigo anta unica
Tall fridge unit with single door

GRIP
POSIZIONE VERTICALE / UPRIGHT POSITION
GRIP A SCOMPARSA / CONCEALED
POSIZIONE VERTICALE / UPRIGHT POSITION
NO
GRIP A SCOMPARSA / CONCEALED

Colonna forno con ante
Tall oven unit with doors

PREMI APRI / PUSH PULL
GRIP
POSIZIONE ORIZZONTALE / HORIZONTAL POSITION
* POSIZIONE VERTICALE / UPRIGHT POSITION
* POSIZIONE VERTICALE / UPRIGHT POSITION
NO
GRIP A SCOMPARSA / CONCEALED
GRIP A SCOMPARSA / CONCEALED

MANIGLIA GRIP

GRIP HANDLE

* Non possibile maniglia GRIP in posizione Verticale per modello NATURAL
GRIP handle not possible in upright position for NATURAL model

POSIZIONAMENTO MANIGLIA "GRIP" E "GRIP A SCOMPARSA" SULLE VARIE TIPOLOGIE DI COLONNE H.210 - 234 cm
"GRIP" AND "GRIP CPNCEALED" HANDLE POSITIONING ON THE VARIOUS TYPES OF TALL UNITS H.210 - 234 cm

Colonna forno con ante e cestone
Tall oven unit with doors and deep-pan drawer

Colonna forno con ante e cesti
Tall oven unit with doors and deep-pan drawers

Colonna forno con ante e cassetti
Tall oven unit with doors and drawers

PREMI APRI / PUSH PULL
GRIP
POSIZIONE ORIZZONTALE / HORIZONTAL POSITION
PREMI APRI / PUSH PULL
GRIP
GRIP
POSIZIONE ORIZZONTALE / HORIZONTAL POSITION
PREMI APRI / PUSH PULL
GRIP
GRIP
GRIP A SCOMPARSA / CONCEALED
FONDO PRESA SAGOMATA / SHAPED BOTTOM
POSIZIONE ORIZZONTALE / HORIZONTAL POSITION

Colonna forno con ante e cassetti + cesto
Tall oven unit with doors and drawer + deep-pan drawer

Colonna forno con ante + anta vela e ante
Tall oven unit with door + door slide and door

Colonna forno con ante + anta vela + cesto
Tall oven unit with door + door slide and door and deep-pan drawer

PREMI APRI / PUSH PULL
GRIP
GRIP
GRIP A SCOMPARSA / CONCEALED
POSIZIONE ORIZZONTALE / HORIZONTAL POSITION
PREMI APRI / PUSH PULL
GRIP
POSIZIONE ORIZZONTALE / HORIZONTAL POSITION
PREMI APRI / PUSH PULL
GRIP
POSIZIONE ORIZZONTALE / HORIZONTAL POSITION

Colonna con estraibile Total-View
Pull-out tall unit with Total-View

GRIP
POSIZIONE VERTICALE / UPRIGHT POSITION
GRIP A SCOMPARSA / CONCEALED
POSIZIONE VERTICALE / UPRIGHT POSITION
NO
GRIP A SCOMPARSA / CONCEALED

Colonna con estraibile 5 cesti interni
Pull-out tall unit with 5 deep-pan drawers

Colonna con estraibile
Pull-out tall unit

GRIP A SCOMPARSA / CONCEALED
POSIZIONE VERTICALE / UPRIGHT POSITION
NO
GRIP A SCOMPARSA / CONCEALED
GRIP A SCOMPARSA / CONCEALED
POSIZIONE VERTICALE / UPRIGHT POSITION
NO
GRIP A SCOMPARSA / CONCEALED

MANIGLIA GRIP

GRIP HANDLE

* Non possibile maniglia GRIP in posizione Verticale per modello NATURAL
GRIP handle not possible in upright position for NATURAL model

POSIZIONAMENTO MANIGLIA "GRIP" E "GRIP A SCOMPARSA" SULLE VARIE TIPOLOGIE DI COLONNE H.210 - 234 cm
 "GRIP" AND "GRIP CPNCEALED" HANDLE POSITIONING ON THE VARIOUS TYPES OF TALL UNITS H.210 - 234 cm

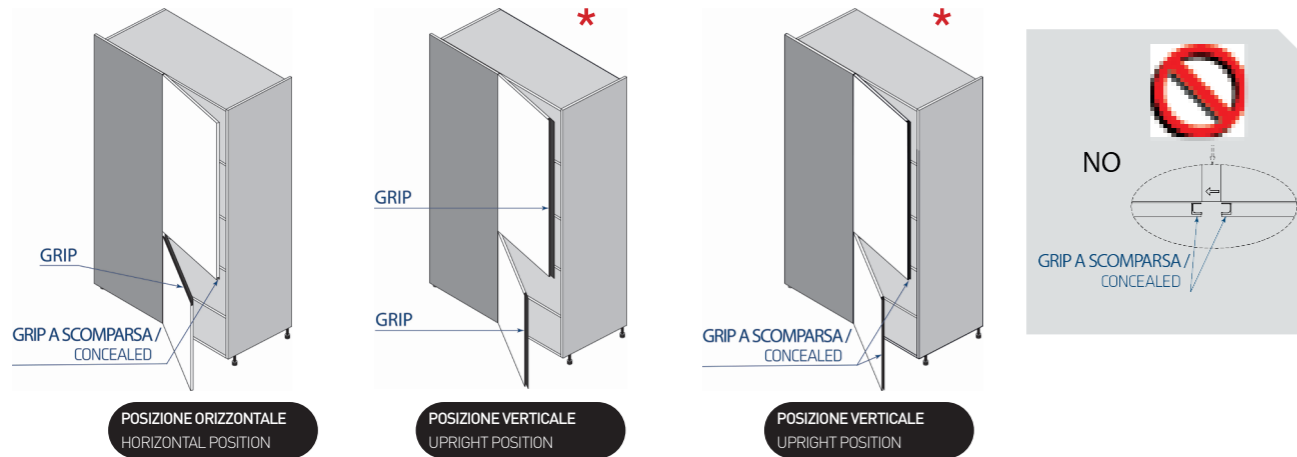
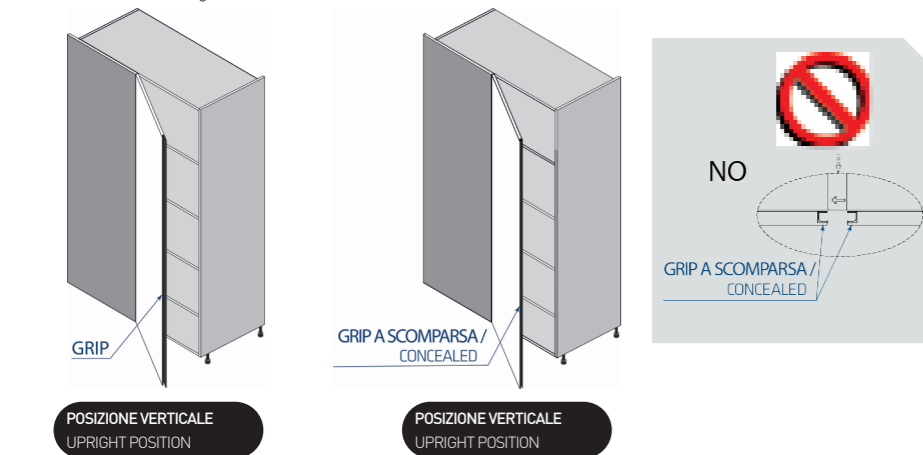
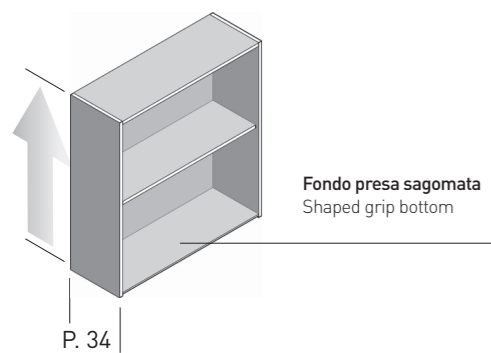
Colonna angolo con ante
 Cornet tall oven with doors

Colonna angolo con anta unica
 Cornet tall oven with single doors

PENSILE CON FONDO PRESA SAGOMATA (DI SERIE)
 WALL UNIT WITH SHAPED GRIP BOTTOM (STANDARD)

 Altezze disponibili:
 Available heights:

 H. 36
 H. 48
 H. 60
 H. 72
 H. 96
 H. 132
ATTENZIONE!

Quando la cucina è con maniglia GRIP, il pensile viene fornito di serie con fondo presa sagomata, per permettere l'apertura dell'anta senza la maniglia

ATTENTION!

When the kitchen is with GRIP handle, the wall unit one is furnished of series with fund shaped taking, to allow the opening of the shutter without the handle

MANIGLIA GRIP

GRIP HANDLE

* Non possibile maniglia GRIP in posizione Verticale per modello NATURAL
GRIP handle not possible in upright position for NATURAL model

POSIZIONAMENTO MANIGLIA "GRIP" E "GRIP A SCOMPARSA" NEI SOPRA COLONNE H.36 - 48 cm
 "GRIP" AND "GRIP CPNCEALED" HANDLE POSITIONING ON THE OVEN TALL UNITS H.36 - 48 cm

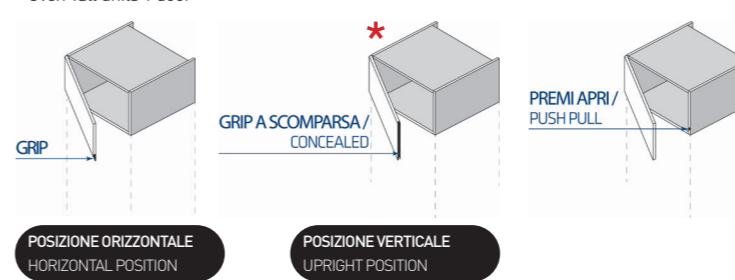
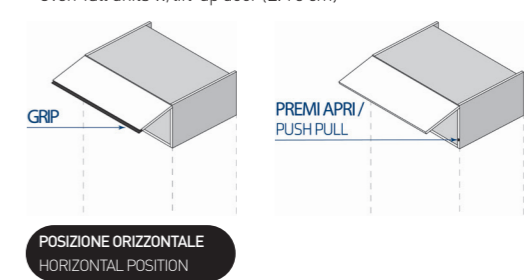
Sopra Colonna 1 anta
 Oven Tall units 1 door

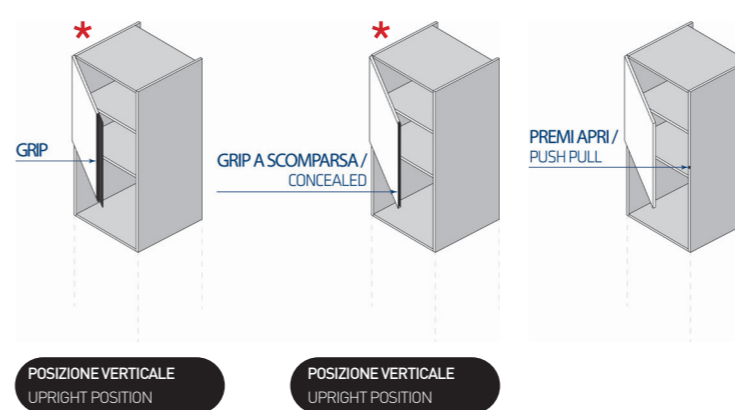
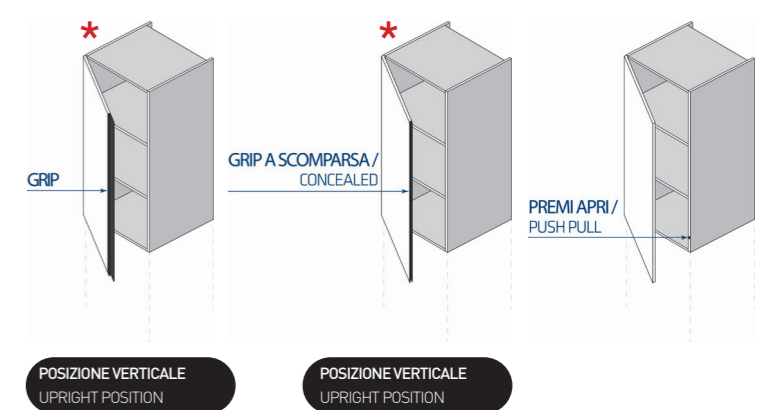
Sopra Colonna Vasistas (L. 75 cm)
 Oven Tall units w/lift-up door (L. 75 cm)

POSIZIONAMENTO MANIGLIA "GRIP" E "GRIP A SCOMPARSA" NELLE COLONNE SOSPESSE H.129 - 153 cm
 "GRIP" AND "GRIP CPNCEALED" HANDLE POSITIONING ON THE SUSPENDED TALL UNITS H.129 - 153 cm

Colonna Sospesa Forno 1 anta
 Suspended Tall Units Oven 1 door

Colonna Sospesa Dispensa 1 anta
 Suspended Tall Units Larder 1 door

MANIGLIE

HANDLES

RISPETTARE OBBLIGATORIAMENTE LE REGOLE DI POSIZIONAMENTO DELLE MANIGLIE, IN CASO CONTRARIO VERRANNO FORNITE LE MANIGLIE SENZA LAVORAZIONI DI FORATURA SUI FRONTALI
IT IS MANDATORY TO COMPLY WITH THE HANDLE POSITIONING RULES; OTHERWISE, HANDLES WILL BE SUPPLIED WITHOUT ANY DRILLING ON THE FRONTS

MANIGLIA HANDLE	INGOMBRO IN PROF. (mm) OVERALL DIMENSIONS IN PROF. (mm)	POSIZIONE POSITION	INTERASSE (mm) CENTRES (mm)	REGOLE POSIZIONAMENTO (RIFERITE ALLA LARGHEZZA DEL FONTELE) POSITIONING RULES (REFERRING TO THE WIDTH OF THE FRONT)
--------------------	---	-----------------------	--------------------------------------	--

BALANCE MRU

Nero Opaco

Matt Black



25

Orizzontale Centrale
Horizontal Central

128

Per anta 147 mm
For doors of 147 mm

Orizzontale Centrale
Horizontal Central

192

Per ante comprese tra 247 e 447 mm
For doors between 247 and 447 mm

Orizzontale Centrale
Horizontal Central

320

Per anta 597 mm
For doors of 597 mm

320

Per ante comprese tra 897 e 1197 mm
For doors between 897 and 1197 mm

BALANCE MRUA

Titanio

Titanium



25

Orizzontale Centrale
Horizontal Central

128

Per anta 147 mm
For doors of 147 mm

Orizzontale Centrale
Horizontal Central

192

Per ante comprese tra 247 e 447 mm
For doors between 247 and 447 mm

Orizzontale Centrale
Horizontal Central

320

Per anta 597 mm
For doors of 597 mm

320

Per ante comprese tra 897 e 1197 mm
For doors between 897 and 1197 mm

METROPOLIS

MAGGIORAZIONE
SURCHARGE

DIRCAMBIO
FOR REPLACEMENT

+ 3

8

0

8

0

12

0

12

+ 3

8

0

8

0

12

0

12

LEGENDA

KEY

0_(zero) = quando sotto la colonna del modello si trova la cifra 0_(zero) È POSSIBILE inserire la maniglia senza nessuna maggiorazione

+ ... = quando sotto la colonna del modello si trova il simbolo + ... con relativo importo È POSSIBILE inserire la maniglia applicando la maggiorazione specifica per ogni modulo

N.D. = quando sotto la colonna del modello si trova la dicitura N.D. significa che la maniglia NON PUÒ ESSERE INSERITA

0_(zero) = when the figure 0_(zero) is indicated under the column of the model the handle can be inserted without any surcharge

+ ... = when the symbol + ... is indicated under the column of the model with relative amount, the handle can be inserted applying the specific surcharge for each module

N.D. = When N.D. is indicated under the column of the model, this means that the handle CAN NOT BE INSERTED

MANIGLIE

HANDLES

RISPETTARE OBBLIGATORIAMENTE LE REGOLE DI POSIZIONAMENTO DELLE MANIGLIE, IN CASO CONTRARIO VERRANNO FORNITE LE MANIGLIE SENZA LAVORAZIONI DI FORATURA SUI FRONTALI
IT IS MANDATORY TO COMPLY WITH THE HANDLE POSITIONING RULES; OTHERWISE, HANDLES WILL BE SUPPLIED WITHOUT ANY DRILLING ON THE FRONTS

MANIGLIA HANDLE	INGOMBRO IN PROF. (mm) OVERALL DIMENSIONS IN PROF. (mm)	POSIZIONE POSITION	INTERASSE (mm) CENTRES (mm)	REGOLE POSIZIONAMENTO (RIFERITE ALLA LARGHEZZA DEL FONTALE) POSITIONING RULES (REFERRING TO THE WIDTH OF THE FRONT)
--------------------	---	-----------------------	--------------------------------------	--

BLADE MRUB

Nero Opaco

Matt Black



30

Orizzontale Centrale
Horizontal Central

96

Per anta 147 mm
For doors of 147 mm

Orizzontale Centrale
Horizontal Central

160

Per ante comprese tra 247 e 447 mm
For doors between 247 and 447 mm

Orizzontale Centrale
Horizontal Central

320

Per anta 597 mm
For doors of 597 mm

320

Per ante comprese tra 897 e 1197 mm
For doors between 897 and 1197 mm

BLADE MRUC

Titanio

Titanium



30

Orizzontale Centrale
Horizontal Central

96

Per anta 147 mm
For doors of 147 mm

Orizzontale Centrale
Horizontal Central

160

Per ante comprese tra 247 e 447 mm
For doors between 247 and 447 mm

Orizzontale Centrale
Horizontal Central

320

Per anta 597 mm
For doors of 597 mm

320

Per ante comprese tra 897 e 1197 mm
For doors between 897 and 1197 mm

NAKED MTA

Peltro

Pewter



29

Orizzontale Centrale
Horizontal Central

160

Per ante comprese tra 260 e 447 mm
For doors between 260 and 447 mm

Verticale Centrale
Vertical Central

160

Per anta 147 mm
For doors of 147 mm

Orizzontale Centrale
Horizontal Central

320

Per anta 597 mm
For doors of 597 mm

Orizzontale Centrale
Horizontal Central

320

Per ante comprese tra 897 e 1.197 mm
For doors between 897 and 1197 mm

METROPOLIS

MAGGIORAZIONE
SURCHARGE

DIRICAMBIO
FOR REPLACEMENT

0

5

0

8

0

8

0

12

0

5

0

8

0

8

0

12

0

8

+ 3

8

0

12

0

12

MANIGLIE

HANDLES

RISPETTARE OBBLIGATORIAMENTE LE REGOLE DI POSIZIONAMENTO DELLE MANIGLIE, IN CASO CONTRARIO VERRANNO FORNITE LE MANIGLIE SENZA LAVORAZIONI DI FORATURA SUI FRONTALI
IT IS MANDATORY TO COMPLY WITH THE HANDLE POSITIONING RULES; OTHERWISE, HANDLES WILL BE SUPPLIED WITHOUT ANY DRILLING ON THE FRONTS

MANIGLIA HANDLE	INGOMBRO IN PROF. (mm) OVERALL DIMENSIONS IN PROF. (mm)	POSIZIONE POSITION	INTERASSE (mm) CENTRES (mm)	REGOLE POSIZIONAMENTO (RIFERITE ALLA LARGHEZZA DEL FONTELE) POSITIONING RULES (REFERRING TO THE WIDTH OF THE FRONT)
--------------------	---	-----------------------	--------------------------------------	--

POCKET MRUD

Nero Opaco

Matt Black



20

Orizzontale Centrale
Horizontal Central

64

Per anta 147 mm
For doors of 147 mm

Orizzontale Centrale
Horizontal Central

128

Per ante comprese tra 260 e 447 mm
For doors between 260 and 447 mm

Orizzontale Centrale
Horizontal Central

192

Per ante comprese tra 597 e 1.197 mm
For doors between 597 and 1.197 mm

POCKET MRUE

Titanio

Titanium



20

Orizzontale Centrale
Horizontal Central

64

Per anta 147 mm
For doors of 147 mm

Orizzontale Centrale
Horizontal Central

128

Per ante comprese tra 260 e 447 mm
For doors between 260 and 447 mm

Orizzontale Centrale
Horizontal Central

192

Per ante comprese tra 597 e 1.197 mm
For doors between 597 and 1.197 mm

METROPOLIS

MAGGIORAZIONE
SURCHARGE

DIRCAMBIO
FOR REPLACEMENT

+ 13

12

+ 10

12

+ 10

16

+ 13

12

+ 10

12

+ 10

16

MANIGLIE

HANDLES

RISPETTARE OBBLIGATORIAMENTE LE REGOLE DI POSIZIONAMENTO DELLE MANIGLIE, IN CASO CONTRARIO VERRANNO FORNITE LE MANIGLIE SENZA LAVORAZIONI DI FORATURA SUI FRONTALI
IT IS MANDATORY TO COMPLY WITH THE HANDLE POSITIONING RULES; OTHERWISE, HANDLES WILL BE SUPPLIED WITHOUT ANY DRILLING ON THE FRONTS

MANIGLIA HANDLE	INGOMBRO IN PROF. (mm) OVERALL DIMENSIONS IN PROF. (mm)	POSIZIONE POSITION	REGOLE POSIZIONAMENTO (RIFERITE ALLA LARGHEZZA DEL FONTALE) POSITIONING RULES (REFERRING TO THE WIDTH OF THE FRONT)
--------------------	---	-----------------------	--

DIAMOND

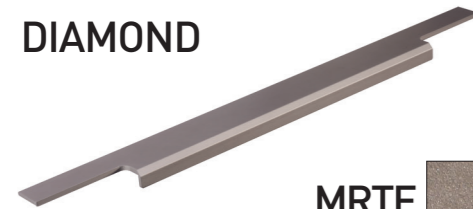

MRTE



TITANIO

20

Orizzontale Centrale
Horizontal Central

Per anta fino a 597 mm
For door up to 597 mm

Orizzontale Centrale
Horizontal Central

Per anta tra 598 e 1197 mm
For door between 597 and 1197

Orizzontale Centrale
Horizontal Central

Per gola 40x40 o 90x90
For groove 40 x 40 mm - 90 x 90 mm

MRTK



NERO OPACO

20

Orizzontale Centrale
Horizontal Central

Per anta fino a 597 mm
For door up to 597 mm

Orizzontale Centrale
Horizontal Central

Per anta tra 598 e 1197 mm
For door between 597 and 1197

Orizzontale Centrale
Horizontal Central

Per gola 40x40 o 90x90
For groove 40 x 40 mm - 90 x 90 mm

METROPOLIS

MAGGIORAZIONE
SURCHARGE

+ 12

+ 18

+ 25

+ 18

+ 30

+ 30

MANIGLIE

HANDLES

RISPETTARE OBBLIGATORIAMENTE LE REGOLE DI POSIZIONAMENTO DELLE MANIGLIE, IN CASO CONTRARIO VERRANNO FORNITE LE MANIGLIE SENZA LAVORAZIONI DI FORATURA SUI FRONTALI
IT IS MANDATORY TO COMPLY WITH THE HANDLE POSITIONING RULES; OTHERWISE, HANDLES WILL BE SUPPLIED WITHOUT ANY DRILLING ON THE FRONTS

MANIGLIA HANDLE	INGOMBRO IN PROF. (mm) OVERALL DIMENSIONS IN PROF. (mm)	LUNGHEZZA MANIGLIA (mm) HANDLE LENGTH (mm)	INTERASSE (mm) CENTRES (mm)	REGOLE POSIZIONAMENTO (RIFERITE ALLA LARGHEZZA DEL FRONTALE) POSITIONING RULES (REFERRING TO THE WIDTH OF THE FRONT)	POSIZIONE POSITION
--------------------	---	---	--------------------------------------	---	-----------------------

GODRONATA

MJGD

BRONZO



30

86	16	Per anta 147 mm For door 147 mm	Orizzontale Centrale Horizontal Central
		Per anta 276,5 mm For door 276,5 mm	Orizzontale Centrale Horizontal Central
137	16	Per anta 280 mm For door 280 mm	Orizzontale Centrale Horizontal Central
		Per anta 297 mm For door 297 mm	Orizzontale Centrale Horizontal Central
237	96	Per anta 331 mm For door 331 mm	Orizzontale Centrale Horizontal Central
		Per anta 397 mm For door 397 mm	Orizzontale Centrale Horizontal Central
287	128	Per anta 447 mm For door 447 mm	Orizzontale Centrale Horizontal Central
437	224	Per anta 597 mm For door 597 mm	Orizzontale Centrale Horizontal Central
		Per anta 647 mm For door 647 mm	Orizzontale Centrale Horizontal Central
587	320	Per anta 747 mm For door 747 mm	Orizzontale Centrale Horizontal Central
		Per anta 1377 mm For door 1377 mm	Verticale Laterale Vertical Side
690	480	Per anta 777 mm For door 777 mm	Verticale Laterale Vertical Side
		Per anta 1317 mm For door 1317 mm	Verticale Laterale Vertical Side
		Per anta 1557 mm For door 1557 mm	Verticale Laterale Vertical Side
737	527	Per anta 897 mm For door 897 mm	Orizzontale Centrale Horizontal Central
		Per anta 1197 mm For door 1197 mm	Orizzontale Centrale Horizontal Central
		Per anta 1497 mm For door 1497 mm	Orizzontale Centrale Horizontal Central
		Per anta 1797 mm For door 1797 mm	Orizzontale Centrale Horizontal Central
		Per anta 2097 mm For door 2097 mm	Verticale Laterale Vertical Side
		Per anta 2167 mm For door 2167 mm	Verticale Laterale Vertical Side
		Per anta 2337 mm For door 2337 mm	Verticale Laterale Vertical Side
Per anta 2397 mm For door 2397 mm	Orizzontale Centrale Horizontal Central		

METROPOLIS

MAGGIORAZIONE
SURCHARGE

+ 7

+ 4

+ 4

+ 4

+ 4

+ 17

+ 17

+ 13

+ 13

+ 23

+ 23

+ 23

+ 23

+ 23

+ 23

+ 23

+ 23

+ 23

+ 23

+ 23

+ 23

MANIGLIE HANDLES

RISPETTARE OBBLIGATORIAMENTE LE REGOLE DI POSIZIONAMENTO DELLE MANIGLIE, IN CASO CONTRARIO VERRANNO FORNITE LE MANIGLIE SENZA LAVORAZIONI DI FORATURA SUI FRONTALI
IT IS MANDATORY TO COMPLY WITH THE HANDLE POSITIONING RULES; OTHERWISE, HANDLES WILL BE SUPPLIED WITHOUT ANY DRILLING ON THE FRONTS

MANIGLIA HANDLE	INGOMBRO IN PROF.(mm) OVERALL DIMENS. DEPTH-WISE(mm)	POSIZIONE POSITION	LUNGHEZZA MANIGLIA(mm) HANDLE LENGTH(mm)	REGOLE POSIZIONAMENTO (RIFERITE ALL' ALTEZZA DEL FRONTALE) POSITIONING RULES (REFERRED TO THE HEIGHT OF THE FRONT)	REGOLE POSIZIONAMENTO (RIFERITE ALLA LARGHEZZA DEL FRONTALE) POSITIONING RULES (REFERRED TO THE WIDTH OF THE FRONT)
MJB NERO OPACO	28	Orizzontale Centrale Horizontal Central	88	-	Per anta 147 mm For 147 mm door
		Orizzontale Centrale Horizontal Central	136	-	Per anta 280 mm For 280 mm door
		Orizzontale Centrale Horizontal Central	136	-	Per anta 297 mm For 297 mm door
		Orizzontale Centrale Horizontal Central	168	-	Per anta 331 mm For 331 mm door
		Orizzontale Centrale Horizontal Central	216	-	Per anta 378 mm For 378 mm door
		Orizzontale Centrale Horizontal Central	285	-	Per anta 397 mm For 397 mm door
		Orizzontale Centrale Horizontal Central	285	-	Per anta 447 mm For 447 mm door
		Orizzontale Centrale Horizontal Central	292	-	Per anta 454 mm For 454 mm door
		Orizzontale Centrale Horizontal Central	435	-	Per anta 597 mm For 597 mm door
		Orizzontale Centrale Horizontal Central	585	-	Per anta 747 mm For 747 mm door
		Orizzontale Centrale Horizontal Central	597	-	Per anta 759 mm For 759 mm door
		Orizzontale Centrale Horizontal Central	735	-	Per anta 897 mm For 897 mm door
		Orizzontale Centrale Horizontal Central	749	-	Per anta 911 mm For 911 mm door
		NEW Orizzontale Centrale Horizontal Central	885	-	Per anta 1047 mm For 1047 mm door
Orizzontale Centrale Horizontal Central	1035	-	Per anta 1197 mm For 1197 mm door		

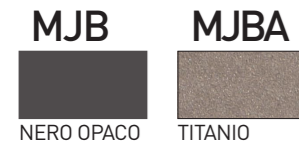



BROOKLYN



Posizione nelle BASI Position in BASE UNIT	Posizione nelle PENSILI Position in WALL UNIT	Posizione nelle COLONNE Position in TALL UNIT	Posizione nelle SOPRA COLONNE Position in OVER TALL UNITS	MAGGIORAZIONE SURCHARGE	
				METROPOLIS	DI RICAMBIO FOR REPLACEMENT
✓	✓	-	-	+ 8	15
-	✓	-	-	+ 8	15
✓	✓	✓	-	+ 8	15
✓	-	-	-	+ 8	15
✓	✓	-	-	+ 8	15
✓	✓	✓	✓	+ 8	15
✓	✓	✓	✓	+ 8	15
✓	✓	-	-	+ 12	25
✓	✓	✓	✓	+ 12	25
-	-	✓	-	+ 16	30
✓	✓	-	-	+ 16	30
✓	✓	✓	✓	+ 20	35
✓	✓	-	-	+ 20	35
✓	✓	-	-	+ 30	45
✓	✓	-	-	+ 30	45

MANIGLIE HANDLES

RISPETTARE OBBLIGATORIAMENTE LE REGOLE DI POSIZIONAMENTO DELLE MANIGLIE, IN CASO CONTRARIO VERRANNO FORNITE LE MANIGLIE SENZA LAVORAZIONI DI FORATURA SUI FRONTALI
IT IS MANDATORY TO COMPLY WITH THE HANDLE POSITIONING RULES; OTHERWISE, HANDLES WILL BE SUPPLIED WITHOUT ANY DRILLING ON THE FRONTS

MANIGLIA HANDLE	INGOMBRO IN PROF. (mm) OVERALL DIMENS. DEPTH-WISE (mm)	POSIZIONE POSITION	LUNGHEZZA MANIGLIA (mm) HANDLE LENGTH (mm)	REGOLE POSIZIONAMENTO (RIFERITE ALL' ALTEZZA DEL FRONTALE) POSITIONING RULES (REFERRED TO THE HEIGHT OF THE FRONT)	REGOLE POSIZIONAMENTO (RIFERITE ALLA LARGHEZZA DEL FRONTALE) POSITIONING RULES (REFERRED TO THE WIDTH OF THE FRONT)
MJB  NERO OPACO		Verticale Laterale Vertical Side	1155	Per anta 1317 mm For 1317 mm door	-
			555	Per anta 717 mm For 717 mm door	-
MJBA  TITANIO		Verticale Laterale Vertical Side	795	Per anta 957 mm For 957 mm door	-
			1395	Per anta 1557 mm For 1557 mm door	-
BROOKLYN 	28	Verticale Laterale Vertical Side	1875	Per anta 2037 mm For 2037 mm door	-
			195	Per anta 357 mm For 357 mm door	-
			315	Per anta 477 mm For 477 mm door	-
			375	Per anta 537 mm For 537 mm door	-
			508	Per anta 670 mm For 670 mm door	-
			268	Per anta 430 mm For 430 mm door	-
			285	Per anta 445 mm For 445 mm door	-
			420	Per anta 582 mm For 582 mm door	-
			NEW 420	Per anta 652 mm For 652 mm door	-
			523	Per anta 685 mm For 685 mm door	-
			615	Per anta 777 mm For 777 mm door	-
			NEW 615	Per anta 847 mm For 847 mm door	-
			1215	Per anta 1377 mm For 1377 mm door	-
			1935	Per anta 2097 mm For 2097 mm door	-
			NEW 1935	Per anta 2097 mm For 2097 mm door	-
			NEW 2175	Per anta 2337 mm For 2337 mm door	-

Posizione nelle BASI Position in BASE UNIT	Posizione nelle PENSILI Position in WALL UNIT	Posizione nelle COLONNE Position in TALL UNIT	Posizione nelle SOPRA COLONNE Position in OVER TALL UNITS	MAGGIORAZIONE SURCHARGE	
				METROPOLIS	DI RICAMBIO FOR REPLACEMENT
-	-	✓	-	+ 30	45
-	-	✓	-	+ 16	30
-	-	✓	-	+ 20	35
-	-	✓	-	+ 40	50
-	-	✓	-	+ 54	65
-	-	-	✓	+ 8	15
-	-	-	✓	+ 12	25
-	-	✓	-	+ 12	25
-	-	✓	-	+ 12	25
-	-	✓	-	+ 8	15
-	-	✓	-	+ 8	15
-	-	✓	-	+ 12	25
-	-	✓	-	+ 12	25
-	-	✓	-	+ 16	30
-	-	✓	-	+ 20	35
-	-	✓	-	+ 20	35
-	-	✓	-	+ 30	45
-	-	✓	-	+ 54	65
-	-	✓	-	+ 54	65
-	-	✓	-	+ 54	65

MANIGLIE

HANDLES

RISPETTARE OBBLIGATORIAMENTE LE REGOLE DI POSIZIONAMENTO DELLE MANIGLIE, IN CASO CONTRARIO VERRANNO FORNITE LE MANIGLIE SENZA LAVORAZIONI DI FORATURA SUI FRONTALI
IT IS MANDATORY TO COMPLY WITH THE HANDLE POSITIONING RULES; OTHERWISE, HANDLES WILL BE SUPPLIED WITHOUT ANY DRILLING ON THE FRONTS

MANIGLIA	CODICE	FINITURA	INGOMBRO IN PROF. (mm)	POSIZIONE	REGOLE POSIZIONAMENTO (RIFERITE ALLA LARGHEZZA DEL FONTALE)
HANDLE	CODE	FINISH	OVERALL DIMENS. DEPTH-WISE (mm)	POSITION	POSITIONING RULES (REFERRED TO THE WIDTH OF THE FRONT)

“L”



modulare anta
modular door

MRTJ		17	Orizzontale Centrale Horizontal Central	Per anta fino a 597 mm For door up to 597 mm
	NERO OPACO			Per anta tra 598 e 1197 mm For door between 598 and 1197
MRTD		17	Orizzontale Centrale Horizontal Central	Per anta tra 1198 e 1797 mm For door between 1198 and 1797
	TITANIO			Per ante maggiori o uguali a 1798 mm For doors longer than or equal to 1798 mm
MRTM		17	Orizzontale Centrale Horizontal Central	Per anta fino a 597 mm For door up to 597 mm
				Per anta tra 598 e 1197 mm For door between 598 and 1197
				Per anta tra 1198 e 1797 mm For door between 1198 and 1797
				Per ante maggiori o uguali a 1798 mm For doors longer than or equal to 1798 mm

DIAGONAL



modulare anta
modular door

MRT		17	Orizz. Centrale/ Verticale laterale Horiz. Central/ Vertical side	Per anta fino a 597 mm For door up to 597 mm
	BIANCO OPACO			Per anta tra 598 e 1197 mm For doors between 598 and 1197
MRTA		17	Orizz. Centrale/ Verticale laterale Horiz. Central/ Vertical side	Per anta tra 1198 e 2166 mm For doors between 1198 and 2166 mm
	TITANIO			Per anta maggiore o uguale a 2167 mm For doors longer than or equal to 2167 mm
MRTI		17	Orizz. Centrale/ Verticale laterale Horiz. Central/ Vertical side	Per lavastoviglie L. 447 e 597 mm For dishwasher L. 447 and 597 mm
	NERO OPACO			Per lavastoviglie L. 747 mm For dishwasher L. 4747 mm
MRTL		17	Orizz. Centrale/ Verticale laterale Horiz. Central/ Vertical side	
	BRONZO			

METROPOLIS

MAGGIORAZIONE SURCHARGE

+ 12

+ 18

+ 30

+ 40

+ 12

+ 18

+ 40

+ 45

+ 12

+ 15

+ 23

+ 30

+ 23

+ 30

GOLA SCAVATA

HOLLOW GROOVE

TUTTI PREZZI DELLE GOLE PER BASI E COLONNE SONO DA SOMMARE AL COSTO DI OGNI SINGOLO ELEMENTO DI LISTINO
ALL GROOVE PRICES FOR BASE UNITS AND TALL UNITS ARE TO BE ADDED TO THE COST OF EACH PRICE LIST ELEMENT

TIPOLOGIA MATERIALE
TYPE OF MATERIAL

COLORI
COLOURS

ALLUMINIO verniciato
Painted ALUMINIUM



Colori in pronta consegna
Available colours

LACCATO OPACO
MATT LACQUERED

Tempi di consegna n° 4 settimane dalla conferma dell'ordine
For on-demand colours, the delivery time is 4 weeks from the order confirmation

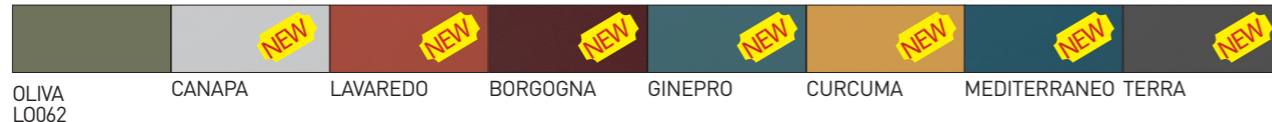

POSIZIONAMENTO GOLA ORIZZONTALE SUPERIORE
UPPER HORIZONTAL GROOVE POSITION

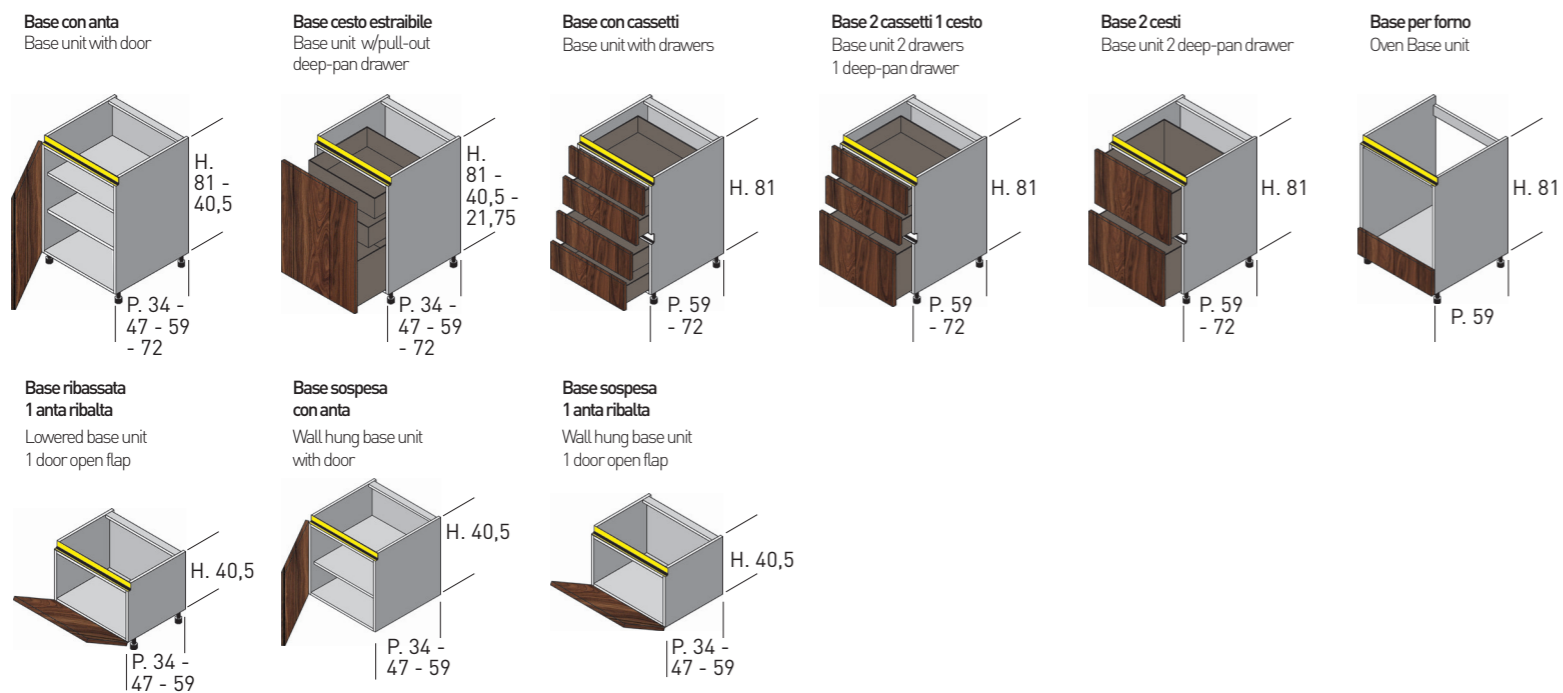

POSIZIONAMENTO GOLA ORIZZONTALE INTERMEDIA
INTERMEDIATE HORIZONTAL GROOVE POSITION

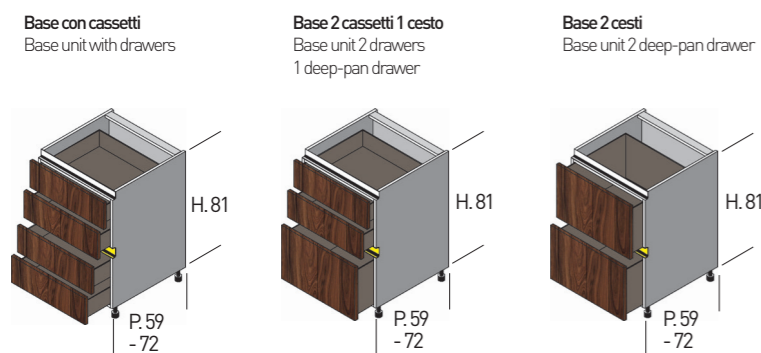

GOLA SCAVATA

HOLLOW GROOVE

TUTTI PREZZI DELLE GOLE PER BASI E COLONNE SONO DA SOMMARE AL COSTO DI OGNI SINGOLO ELEMENTO DI LISTINO
ALL GROOVE PRICES FOR BASE UNITS AND TALL UNITS ARE TO BE ADDED TO THE COST OF EACH PRICE LIST ELEMENT

POSIZIONAMENTO GOLA VERTICALE SINGOLA
SINGLE VERTICAL GROOVE POSITION

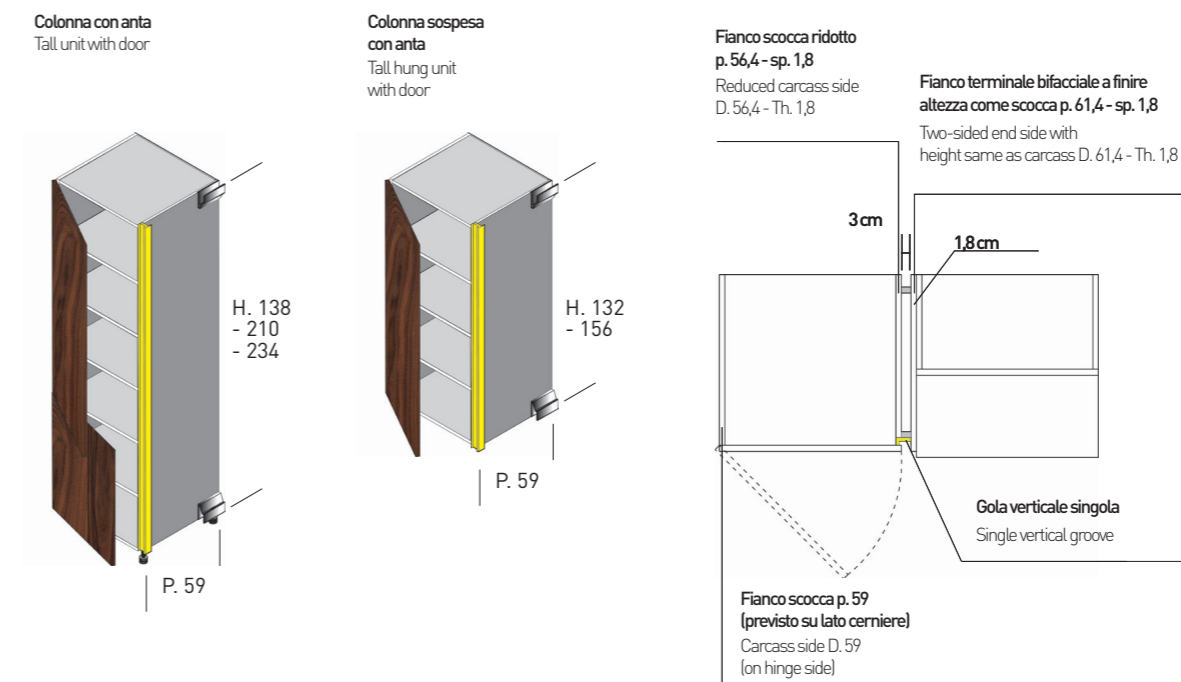

ATTENZIONE!
In presenza di gola singola, considerare sempre fianco di finitura con relativo costo
Vedi pg. 302-303

ATTENTION!
In the presence of single groove, always consider the finishing side with relative cost
See pg. 302-303

POSIZIONAMENTO GOLA VERTICALE DOPPIA
DOUBLE VERTICAL GROOVE POSITION

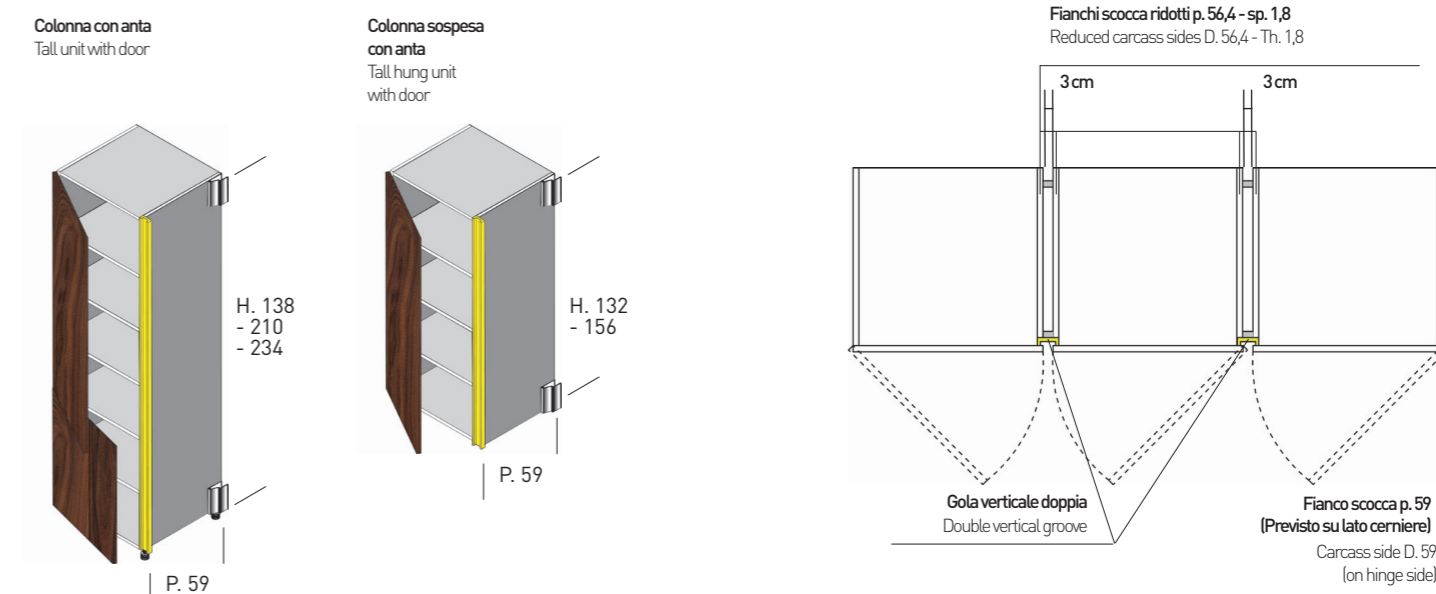

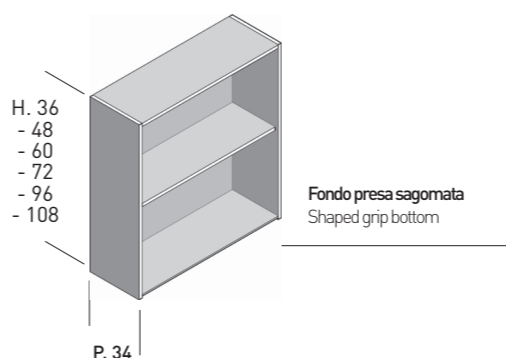

PENSILE CON FONDO PRESA SAGOMATA (DI SERIE)
WALL UNIT WITH SHAPED GRIP BOTTOM (STANDARD)



ATTENZIONE!
Quando la cucina è con Gola, il pensile viene fornito di serie con fondo presa sagomata, per permettere l'apertura dell' anta senza la maniglia

ATTENTION!
When the kitchen is with Groove, the wall unit one is furnished of series with fund shaped taking, to allow the opening of the shutter without the handle

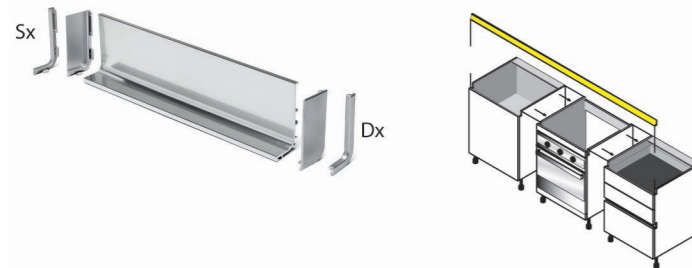
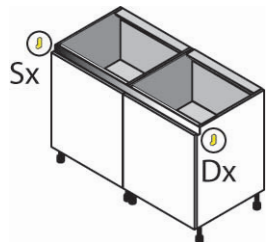
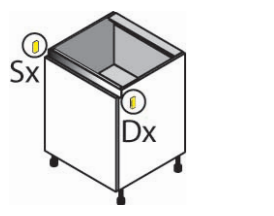
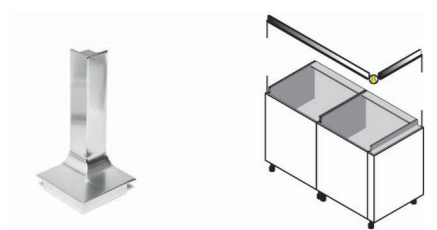
KIT GOLA ORIZZONTALE SINGOLA SUPERIORE**SCAVATA PER BASI**SINGLE UPPER HORIZONTAL HOLLOW GROOVE KIT
FOR BASE UNITSTAPPI IN PVC PREVISTI DI SERIE; AD ECCEZIONE DELLE COLORAZIONI LACCATE,
PER I QUALI È PREVISTO UN COSTO AGGIUNTIVO
PVC CAPS AS STANDARD; EXCEPT FOR LACQUERED COLOURS,
FOR WHICH AN ADDITIONAL COST IS REQUIRED

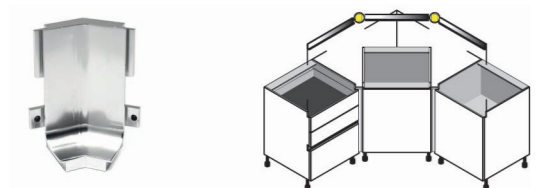
ARTICOLO ARTICLE	DESCRIZIONE DESCRIPTION	CODICE CODE
	GOLA ORIZZONTALE SINGOLA SUPERIORE SCAVATA 1 Barra al ml. 2 Tappi chiusi in plastica (1 Dx - 1 Sx) 2 Tappi terminali aperti in plastica (1 Dx - 1 Sx) KIT IN DOTAZIONE DI SERIE SINGLE UPPER HORIZONTAL HOLLOW GROOVE 1 bar per lm 2 closed plastic caps (1 RH - 1 LH) 2 open plastic end caps (1 RH - 1 LH) STANDARD-SUPPLIED KIT	JE00.01
	TAPPO TERMINALE APERTO LACCATO ELEMENTO OPZIONALE LACQUERED OPEN END CAP OPTIONAL ELEMENT	Sx 5FME0519.. LH Dx 5FME051A.. RH
	TAPPO CHIUSO LACCATO ELEMENTO OPZIONALE LACQUERED CLOSED CAP OPTIONAL ELEMENT	Sx 5FME051B.. LH Dx 5FME051C.. RH
	ANGOLARE A 90° ESTERNO 90° EXTERNAL CORNER ELEMENT	Cad.1 Each 5FME0609..
	MULTIANGOLO INTERNO VARIABILE DA 75° A 90° - DA 90° A 105° VARIABLE INTERNAL MULTI-CORNER ELEMENT FROM 75° TO 90° - FROM 90° TO 105°	Cad.1 Each 5FME060B..
	ANGOLARE A 135° INTERNO 135° INTERNAL CORNER ELEMENT	Cad.1 Each 5FME060A..

BRILL	PIOMBO OPACO - TITANIO	BIANCO OPACO	TITANIO	NERO SPAZZOLATO	LACCATO OPACO
31	31	31	31	31	60
-	-	-	-	-	26
-	-	-	-	-	26
-	-	-	-	-	26
-	-	-	-	-	26
35	34	34	34	34	54
72	72	72	72	72	65
42	40	40	40	40	62

**KIT GOLA ORIZZONTALE DOPPIA INTERMEDIA
SCAVATA PER BASI**
DOUBLE INTERMEDIATE HORIZONTAL HOLLOW GROOVE KIT
FOR BASE UNITS

TAPPI IN PVC PREVISTI DI SERIE; AD ECCEZIONE DELLE COLORAZIONI LACCATE,
PER I QUALI È PREVISTO UN COSTO AGGIUNTIVO
PVC CAPS AS STANDARD; EXCEPT FOR LACQUERED COLOURS,
FOR WHICH AN ADDITIONAL COST IS REQUIRED

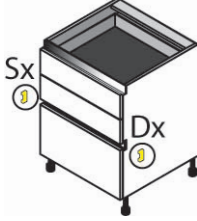
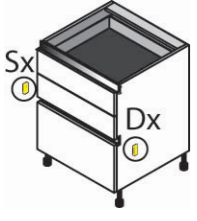
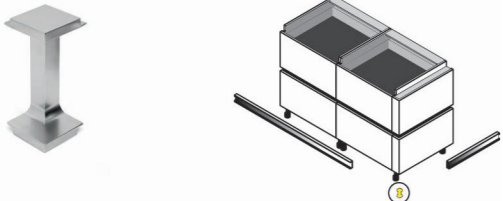
ARTICOLO ARTICLE	DESCRIZIONE DESCRIPTION		CODICE CODE
	GOLA ORIZZONTALE DOPPIA INTERMEDIA SCAVATA 1 Barra al ml. 2 Tappi in plastica 2 Tappi terminali aperti in plastica KIT IN DOTAZIONE DI SERIE DOUBLE INTERMEDIATE HORIZONTAL HOLLOW GROOVE 1 bar per lm 2 plastic caps 2 open plastic end caps STANDARD-SUPPLIED KIT	Al ml. per lm	JE00.02
	TAPPO TERMINALE APERTO LACCATO ELEMENTO OPZIONALE LACQUERED OPEN END CAP OPTIONAL ELEMENT	Sx LH Dx RH	5FME0516.. 5FME0516..
	TAPPO CHIUSO LACCATO ELEMENTO OPZIONALE LACQUERED CLOSED CAP OPTIONAL ELEMENT	Sx LH Dx RH	5FME0515.. 5FME0515..
	ANGOLARE A 90° ESTERNO 90° EXTERNAL CORNER ELEMENT	Cad.1 Each	5FME0604..

BRILL	PIOMBO OPACO - BRONZO	BIANCO OPACO	TITANIO	NERO SPAZZOLATO	LACCATO OPACO
31	31	31	31	31	60
-	-	-	-	-	26
-	-	-	-	-	26
-	-	-	-	-	26
-	-	-	-	-	26
36	36	36	36	36	26

KIT GOLA VERTICALE SINGOLA SCAVATA

PER COLONNE

SINGLE VERTICAL HOLLOW GROOVE KIT
FOR TALL UNIT

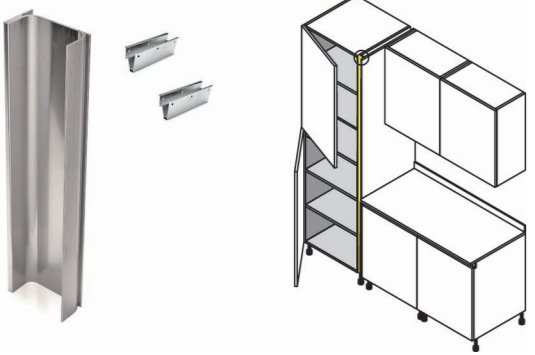
ARTICOLO ARTICLE	DESCRIZIONE DESCRIPTION	CODICE CODE
	GOLA VERTICALE SINGOLA SCAVATA 1 Barra H. 132 - 138 - 210 - 234 Supporti con velcro 2 Coppie di distanziali posteriori KIT IN DOTAZIONE DI SERIE SINGLE VERTICAL HOLLOW GROOVE 1 bar H 132 - 138 - 210 - 234 Supports with Velcro 2 pairs of rear spacers STANDARD-SUPPLIED KIT	H.132 (Cad.1) H.132 (Each) JF13.01 H.138 (Cad.1) H.138 (Each) JF14.01 H.210 (Cad.1) H.210 (Each) JF21.01 H.234 (Cad.1) H.234 (Each) JF23.01
	CARTER DI PROTEZIONE FORNO a misura DA AGGIUNGERE ALLA GOLA VERTICALE IN PRESENZA DI FORNO OVEN GUARD to length TO BE ADDED TO THE VERTICAL GROOVE WHEN OVEN IS INCLUDED	ALTEZZA fino a H. 60 cm (Cad.1) HEIGHT until H. 60 cm (Each) JR06.01 ALTEZZA compresa tra H. 60 e 120 cm (Cad.1) HEIGHT between H. 60 and 120 cm (Each) JR12.01
	PROFILO ANTIRIFLESSO 1 Barra H. 132 - 138 - 210 - 234 DA AGGIUNGERE ALLA GOLA VERTICALE SUL LATO CERNIERE DELLA COLONNA ANTI-GLARE PROFILE 1 bar H 132 - 138 - 210 - 234 TO BE ADDED TO THE VERTICAL GROOVE ON THE HINGE SIDE OF THE TALL UNIT	H.132 (Cad.1) H.132 (Each) JR13.01 H.138 (Cad.1) H.138 (Each) JR14.01 H.210 (Cad.1) H.210 (Each) JR21.01 H.234 (Cad.1) H.234 (Each) JR23.01

BRILL	PIOMBO OPACO - BRONZO	BIANCO OPACO	TITANIO	NERO SPAZZOLATO	LACCATO OPACO
80	106	106	80	80	175
80	106	106	80	80	175
107	139	139	107	107	249
113	152	152	113	113	269

14	14	14	14	14	70
28	28	28	28	28	168

25	--	--	--	--	--
25	--	--	--	--	--
36	--	--	--	--	--
41	--	--	--	--	--

FIANCHI TERMINALI BIFACCIALI PER GOLA VERTICALE SINGOLA SCAVATA

DOUBLE-FACE END PANELS FOR SINGLE VERTICAL HOLLOW GROOVE

ARTICOLO ARTICLE	DESCRIZIONE Description	PROF. (cm) DEPTH (cm)	CODICE CODE
	FIANCO TERMINALE PER GOLA VERTICALE SINGOLA SCAVATA SP. 1,8 cm H. 132 - 138 - 210 - 234 cm END PANEL FOR HOLLOW SINGLE VERTICAL GROOVE TH. 1.8 cm H 132 - 138 - 210 - 234 cm		
	[Colonna H.138 pr. 59] [Tall unit H.138 D. 59]	61,4	N136_00
	[Colonna H.210 pr. 34] [Tall unit H.210 D. 34]	36,4	N213_01
	[Colonna H.210 pr. 59] [Tall unit H.210 D. 59]	61,4	N216_00
[Colonna H.234 pr. 59] [Tall unit H.234 D. 59]	61,4	N236_00	

NOBILITATO colore scocca MELAMINE carcass colour	TERMO STRUTTURATO THERMO TEXTURED	LAMINATO MATERICO TEXTURED LAMINATE	PET PET	FENIX FENIX
30	64	82	89	146
27	58	90	83	131
43	94	144	130	220
48	108	157	148	248

KIT GOLA VERTICALE DOPPIA SCAVATA

PER COLONNE

DOUBLE VERTICAL HOLLOW GROOVE KIT
FOR TALL UNITS

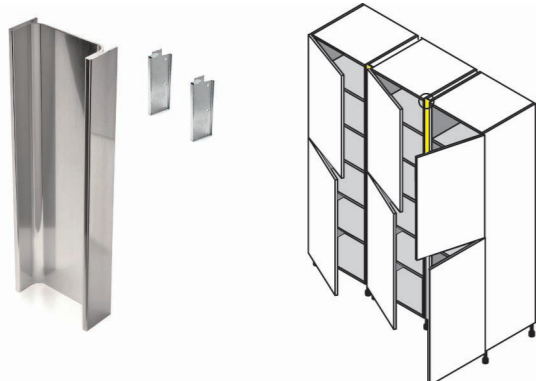
ARTICOLO ARTICLE	DESCRIZIONE DESCRIPTION	CODICE CODE	
	GOLA VERTICALE DOPPIA SCAVATA 1 Barra H. 132 - 138 - 210 - 234 Supporti con velcro 2 Coppie di distanziali posteriori KIT IN DOTAZIONE DI SERIE DOUBLE VERTICAL HOLLOW GROOVE 1 bar H 132 - 138 - 210 - 234 Supports with Velcro 2 pairs of rear spacers STANDARD-SUPPLIED KIT	H.132 (Cad.1) H.132 (Each) H.138 (Cad.1) H.138 (Each) H.210 (Cad.1) H.210 (Each) H.234 (Cad.1) H.234 (Each)	JF13.02 JF14.02 JF21.02 JF23.02
	CARTER DI PROTEZIONE FORNO a misura DA AGGIUNGERE ALLA GOLA VERTICALE IN PRESENZA DI FORNO OVEN GUARD to lenght TO BE ADDED TO THE VERTICAL GROOVE WHEN OVEN IS INCLUDED	ALTEZZA fino a H. 60 cm (Cad.1) HEIGHT until H. 60 cm (Each) ALTEZZA compresa tra H. 60 e 120 cm (Cad.1) HEIGHT between H. 60 and 120 cm (Each)	JR06.01 JR12.01
	PROFILO ANTIRIFLESSO 1 Barra H. 132 - 138 - 210 - 234 DA AGGIUNGERE ALLA GOLA VERTICALE SUL LATO CERNIERE DELLA COLONNA ANTI-GLARE PROFILE 1 bar H 132 - 138 - 210 - 234 TO BE ADDED TO THE VERTICAL GROOVE ON THE HINGE SIDE OF THE TALL UNIT	H.132 (Cad.1) H.132 (Each) H.138 (Cad.1) H.138 (Each) H.210 (Cad.1) H.210 (Each) H.234 (Cad.1) H.234 (Each)	JR13.01 JR14.01 JR21.01 JR23.01

BRILL	PIOMBO OPACO - BRONZO	BIANCO OPACO	TITANIO	NERO SPAZZOLATO	LACCATO OPACO
80	106	106	80	80	175
80	106	106	80	80	175
107	139	139	107	107	249
113	152	152	113	113	269
14	14	14	14	14	70
28	28	28	28	28	168
25	--	--	--	--	--
25	--	--	--	--	--
36	--	--	--	--	--
41	--	--	--	--	--

GOLA PIATTA

FLAT GROOVE

TUTTI PREZZI DELLE GOLE PER BASI E COLONNE SONO DA SOMMARE AL COSTO DI OGNI SINGOLO ELEMENTO DI LISTINO
ALL GROOVE PRICES FOR BASE UNITS AND TALL UNITS ARE TO BE ADDED TO THE COST OF EACH PRICE LIST ELEMENT

TIPOLOGIA MATERIALE
TYPE OF MATERIAL

COLORI
COLOURS

ALLUMINIO verniciato

Painted ALUMINIUM



Colori in pronta consegna
Available colours



ATTENZIONE!

con la GOLA PIATTA è necessario conteggiare questa maniglia apposita

ATTENTION!

with FLAT GROOVE this special handle must be counted



- Cod. MVAD Brill
- Cod. MVAE Bianco Opaco
- Cod. MVAF Piombo Opaco
- Cod. MVAH Titanio
- Cod. MVAI Nero Spazzolato
- Cod. MVAJ Bronzo

PTS. + 15
PTS. + 15
PTS. + 15
PTS. + 15
PTS. + 15
PTS. + 15

POSIZIONAMENTO GOLA ORIZZONTALE SINGOLA SUPERIORE

UPPER SINGLE HORIZONTAL GROOVE POSITION

<p>Base con anta Base unit with door</p> <p>H. 81 - 40,5 P. 34 - 47 - 59 - 72</p>	<p>Base cesto estraibile Base unit w/pull-out deep-pan drawer</p> <p>H. 81 - 40,5 - 21,75 P. 34 - 47 - 59 - 72</p>	<p>Base con cassetti Base unit with drawers</p> <p>H. 81 P. 59 - 72</p>	<p>Base 2 cassetti 1 cesto Base unit 2 drawers 1 deep-pan drawer</p> <p>H. 81 P. 59 - 72</p>	<p>Base 2 cesti Base unit 2 deep-pan drawer</p> <p>H. 81 P. 59 - 72</p>	<p>Base per forno Oven Base unit</p> <p>H. 81 P. 59</p>
<p>Base ribassata 1 anta ribalta Lowered base unit 1 door open flap</p> <p>H. 40,5 P. 34 - 47 - 59</p>	<p>Base sospesa con anta Wall hung base unit with door</p> <p>H. 40,5 P. 34 - 47 - 59</p>	<p>Base sospesa 1 anta ribalta Wall hung base unit 1 door open flap</p> <p>H. 40,5 P. 34 - 47 - 59</p>			

POSIZIONAMENTO GOLA ORIZZONTALE DOPPIA INTERMEDIA

INTERMEDIATE DOUBLE HORIZONTAL GROOVE POSITION

<p>Base con cassetti Base unit with drawers</p> <p>H. 81 P. 59 - 72</p>	<p>Base 2 cassetti 1 cesto Base unit 2 drawers 1 deep-pan drawer</p> <p>H. 81 P. 59 - 72</p>	<p>Base 2 cesti Base unit 2 deep-pan drawer</p> <p>H. 81 P. 59 - 72</p>
--	---	--

GOLA PIATTA

FLAT GROOVE

TUTTI PREZZI DELLE GOLE PER BASI E COLONNE SONO DA SOMMARE AL COSTO DI OGNI SINGOLO ELEMENTO DI LISTINO
ALL GROOVE PRICES FOR BASE UNITS AND TALL UNITS ARE TO BE ADDED TO THE COST OF EACH PRICE LIST ELEMENT

POSIZIONAMENTO GOLA VERTICALE SINGOLA

SINGLE VERTICAL GROOVE POSITION

<p>Colonna con anta Tall unit with door</p> <p>H. 138 - 210 - 234 P. 59</p>	<p>Colonna sospesa con anta Tall hung unit with door</p> <p>H. 132 - 156 P. 59</p>	<p>Fianco scocca ridotto p. 56,4 - sp. 1,8 Reduced carcass side D. 56,4 - Th. 1,8</p> <p>Fianco terminale bifacciale a finire altezza come scocca p. 61,4 - sp. 1,8 Two-sided end side with height same as carcass D. 61,4 - Th. 1,8</p> <p>3cm 1,8cm Gola verticale singola Single vertical groove</p> <p>Fianco scocca p. 59 (previsto su lato cerniere) Carcass side D. 59 (on hinge side)</p>
--	---	--

ATTENZIONE!

In presenza di gola singola, considerare sempre fianco di finitura con relativo costo Vedi pg. 312-313

ATTENTION!

In the presence of single groove, always consider the finishing side with relative cost See pg. 312-313

POSIZIONAMENTO GOLA VERTICALE DOPPIA

DOUBLE VERTICAL GROOVE POSITION

<p>Colonna con anta Tall unit with door</p> <p>H. 138 - 210 - 234 P. 59</p>	<p>Colonna sospesa con anta Tall hung unit with door</p> <p>H. 132 - 156 P. 59</p>	<p>Fianchi scocca ridotti p. 56,4 - sp. 1,8 Reduced carcass sides D. 56,4 - Th. 1,8</p> <p>3cm 3cm Gola verticale doppia Double vertical groove</p> <p>Fianco scocca p. 59 (Previsto su lato cerniere) Carcass side D. 59 (on hinge side)</p>
--	---	---

PENSILE CON FONDO PRESA SAGOMATA (DI SERIE)

WALL UNIT WITH SHAPED GRIP BOTTOM (STANDARD)

H. 36 - 48 - 60 - 72 - 96 - 108
P. 34

Fondo presa sagomata
Shaped grip bottom



ATTENZIONE!

Quando la cucina è con Gola, il pensile viene fornito di serie con fondo presa sagomata, per permettere l'apertura dell' anta senza la maniglia

ATTENTION!

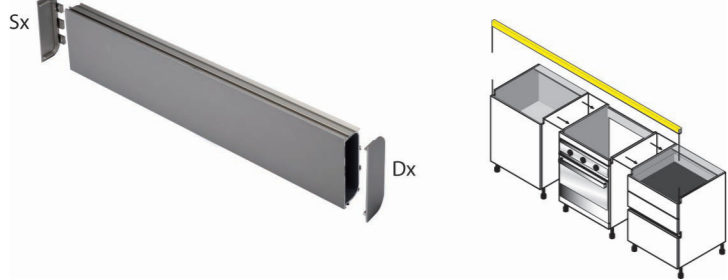
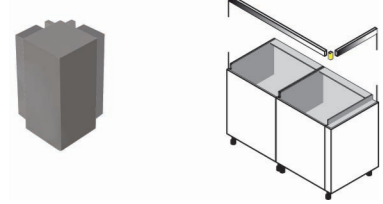
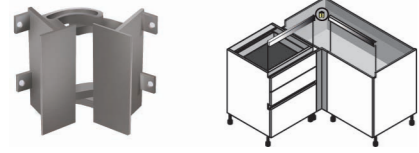

When the kitchen is with Groove, the wall unit one is furnished of series with fund shaped taking, to allow the opening of the shutter without the handle

KIT GOLA ORIZZONTALE SINGOLA SUPERIORETAPPI IN PVC PREVISTI DI SERIE
PVC CAPS AS STANDARD**PIATTA PER BASI**SINGLE UPPER HORIZONTAL FLAT GROOVE KIT
FOR BASE UNITS

ARTICOLO ARTICLE	DESCRIZIONE DESCRIPTION		CODICE CODE
	GOLA ORIZZONTALE SINGOLA SUPERIORE PIATTA 1 Barra al ml. 2 Tappi chiusi in platicca (1 Dx - 1 Sx) KIT IN DOTAZIONE DI SERIE SINGLE UPPER HORIZONTAL FLAT GROOVE 1 bar per lm 2 closed plastic caps (1 RH - 1 LH) STANDARD-SUPPLIED KIT	Al ml. per lm	JE00.03
	ANGOLARE A 90° ESTERNO 90° EXTERNAL CORNER ELEMENT	Cad.1 Each	5FME1609..
	MULTIANGOLO INTERNO VARIABILE DA 75° A 90° - DA 90° A 105° VARIABLE INTERNAL MULTI-CORNER ELEMENT FROM 75° TO 90° - FROM 90° TO 105°	Cad.1 Each	5FME160B..
	ANGOLARE A 135° INTERNO 135° INTERNAL CORNER ELEMENT	Cad.1 Each	5FME160A..

BRILL	PIOMBO OPACO - BRONZO	BIANCO OPACO	TITANIO	NERO SPAZZOLATO
31	31	31	31	31
35	34	34	34	34
55	51	51	51	51
42	40	40	40	40

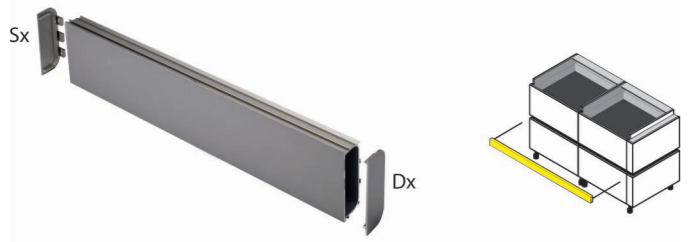
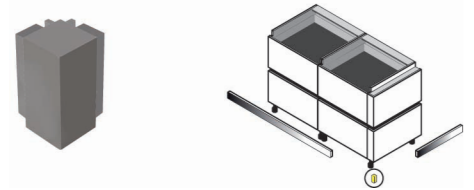
KIT GOLA ORIZZONTALE DOPPIA INTERMEDIATAPPI IN PVC PREVISTI DI SERIE
PVC CAPS AS STANDARD**PIATTA PER BASI**DOUBLE INTERMEDIATE HORIZONTAL FLAT GROOVE KIT
FOR BASE UNITS

ARTICOLO ARTICLE	DESCRIZIONE DESCRIPTION		CODICE CODE
	GOLA ORIZZONTALE DOPPIA INTERMEDIA PIATTA 1 Barra al ml. 2 Tappi in plasitica KIT IN DOTAZIONE DI SERIE DOUBLE INTERMEDIATE HORIZONTAL FLAT GROOVE 1 bar per lm 2 plastic caps STANDARD-SUPPLIED KIT	Al ml. per lm	JE00.04
	ANGOLARE A 90° ESTERNO 90° EXTERNAL CORNER ELEMENT	Cad.1 Each	5FME1604..
	MAGGIORAZIONE INSERIMENTO MANIGLIA PER GOLA PIATTA SURCHARGE HANDLE INSERTION FOR FLAT GROOVE	Cad.1 Each	-

BRILL	PIOMBO OPACO - BRONZO	BIANCO OPACO	TITANIO	NERO SPAZZOLATO
31	31	31	31	31
38	36	36	36	36
+15	+15	+15	+15	+15

KIT GOLA VERTICALE SINGOLA PIATTA

PER COLONNE

SINGLE VERTICAL FLAT GROOVE KIT
FOR TALL UNITS

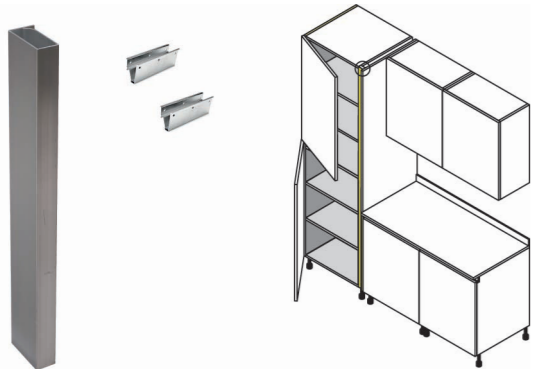
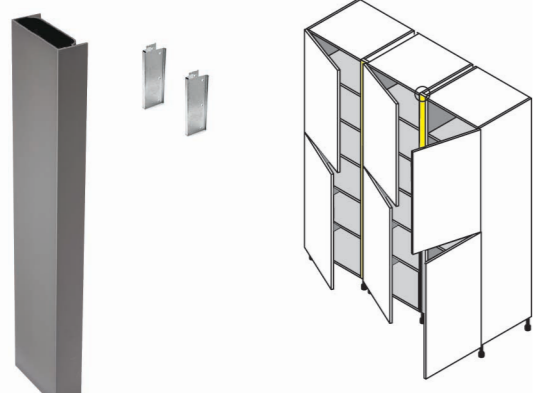
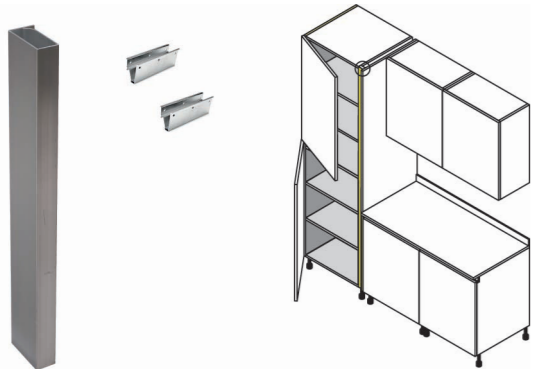
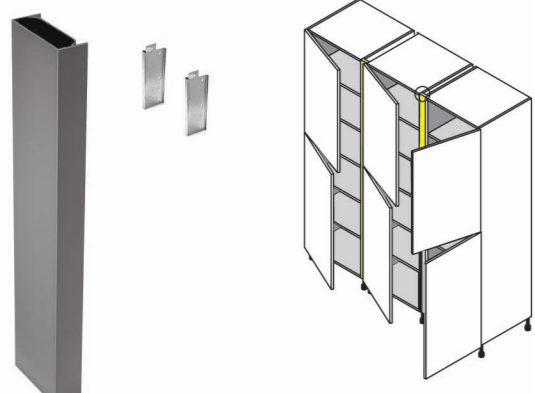
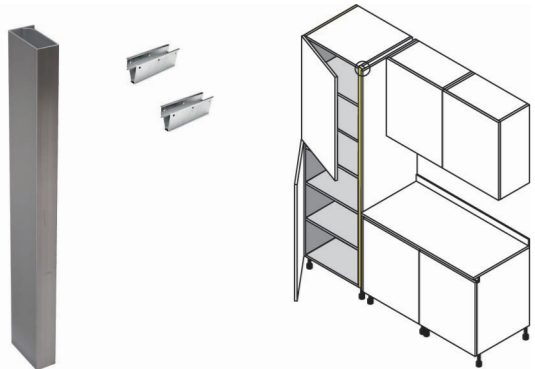
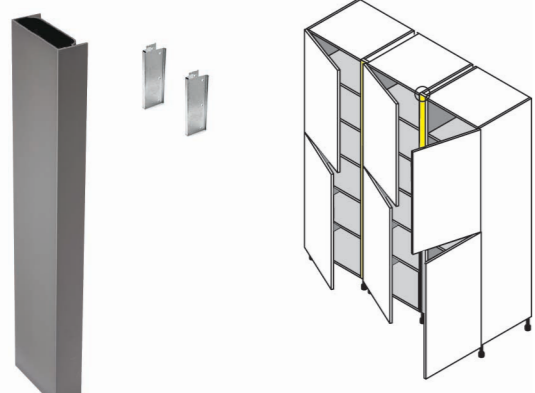
ARTICOLO ARTICLE	DESCRIZIONE DESCRIPTION	CODICE CODE
	GOLA VERTICALE SINGOLA PIATTA	H.132 (Cad.1)
	1 Barra H. 132 - 138 - 210 - 234	H.132 (Each)
	Supporti con velcro	H.138 (Cad.1)
	2 Coppie di distanziali posteriori	H.138 (Each)
	GOLA VERTICALE DOPPIA PIATTA	H.132 (Cad.1)
	1 Barra H. 132 - 138 - 210 - 234	H.132 (Each)
	Supporti con velcro	H.138 (Cad.1)
	2 Coppie di distanziali posteriori	H.138 (Each)
	KIT IN DOTAZIONE DI SERIE	H.210 (Cad.1)
	SINGLE VERTICAL FLAT GROOVE	H.210 (Each)
	1 bar H 132 - 238 - 210 - 234	H.234 (Cad.1)
	Supports with Velcro	H.234 (Each)
	DOUBLE VERTICAL FLAT GROOVE	H.210 (Cad.1)
	1 bar H 132 - 238 - 210 - 234	H.210 (Each)
	Supports with Velcro	H.234 (Cad.1)
	2 pairs of rear spacers	H.234 (Each)
	STANDARD-SUPPLIED KIT	JF13.03
	STANDARD-SUPPLIED KIT	JF13.04

FIANCHI TERMINALI BIFACCIALI PER GOLA VERTICALE SINGOLA PIATTA

DOUBLE-FACE END PANELS FOR SINGLE VERTICAL FLAT GROOVE

ARTICOLO ARTICLE	DESCRIZIONE Description	PROF. (cm) DEPTH (cm)	CODICE CODE
	FIANCO TERMINALE PER GOLA VERTICALE SINGOLA SCAVATA		
	SP. 1,8 cm H. 132 - 138 - 210 - 234 cm		
	END PANEL FOR HOLLOW SINGLE VERTICAL GROOVE		
	TH. 1.8 cm H 132 - 138 - 210 - 234 cm		
	[Colonna H.138 pr. 59]	61,4	N136_00
	[Tall unit H.138 D. 59]		
	[Colonna H.210 pr. 34]	36,4	N213_01
	[Tall unit H.210 D. 34]		
	[Colonna H.210 pr. 59]	61,4	N216_00
	[Tall unit H.210 D. 59]		
	[Colonna H.234 pr. 59]	61,4	N236_00
	[Tall unit H.234 D. 59]		



BRILL	PIOMBO OPACO - BRONZO	BIANCO OPACO	TITANIO	NERO SPAZZOLATO
80	106	106	80	80
80	106	106	80	80
107	139	139	107	107
113	152	152	113	113



80	106	106	80	80
80	106	106	80	80
107	139	139	107	107
113	152	152	113	113

NOBILITATO colore scocca MELAMINE carcass colour	TERMO STRUTTURATO THERMO TEXTURED	LAMINATO MATERICO TEXTURED LAMINATE	PET PET	FENIX FENIX
30	64	82	89	146
27	58	90	83	131
43	94	144	130	220
48	108	157	148	248

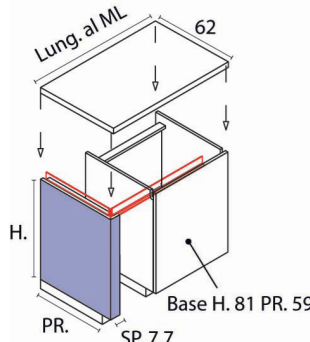
ELEMENTI PER GOLA

GROOVE ELEMENTS

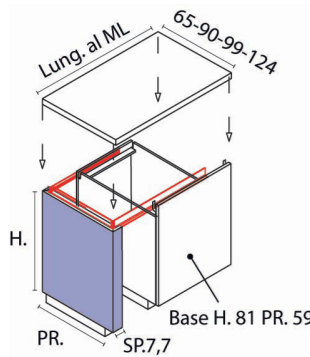
ARTICOLO ARTICLE	DESCRIZIONE DESCRIPTION	H.(cm) H.(cm)	SP.(cm) TH.(cm)	CODICE CODE
	FIANCONE PER BASE A PARETE, gola superiore LARGE SIDE PANEL FOR BASE UNIT WALL, flat groove			
	(per piani prof. 62 cm) (for worktops depth 62 cm)	77,7	7,7 / 7,75	F0816LP
				

ARTICOLO ARTICLE	DESCRIZIONE DESCRIPTION	H.(cm) H.(cm)	SP.(cm) TH.(cm)	CODICE CODE
	FIANCONE PER ISOLA E PENISOLA, gola superiore LARGE SIDE PANEL FOR ISLAND AND PENINSULA, flat groove			
	(per piani prof. 65 cm) (for worktops depth 65 cm)	77,7	7,7 / 7,75	F081ALP
	(per piani prof. 90 cm) (for worktops depth 90 cm)	77,7	7,7 / 7,75	F0818LP
	(per piani prof. 124 cm) (for worktops depth 124 cm)	77,7	7,7 / 7,75	F0811LP
				

E1	E2	E4
234	234	258

234	234	258
282	282	311
309	309	348

	METROPOLIS
SP. (cm) TH.(cm)	7,7



Spessore variabile, vedi tabella accanto per lo spessore associato al modello di riferimento
Varying thickness, sees table opposite for the thickness associated to the reference model



Non possibile accostare a basi per Lavastoviglie e Lavatrici
Dishwasher and Washing machine units cannot be placed together

ELEMENTI PER GOLA

GROOVE ELEMENTS

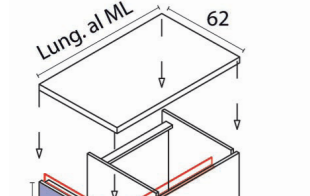
ARTICOLO ARTICLE	DESCRIZIONE DESCRIPTION	H.(cm) H.(cm)	SP.(cm) TH.(cm)	CODICE CODE	
	FIANCONE PER BASE A PARETE, gola intermedia LARGE SIDE PANEL FOR BASE UNIT WALL, flat intermediate	(per piani prof. 62 cm) (for worktops depth 62 cm)	77,7	7,7 / 7,75	H0816LP

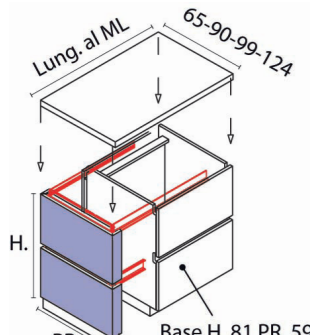

	FIANCONE PER ISOLA E PENISOLA, gola intermedia LARGE SIDE PANEL FOR ISLAND AND PENINSULA, flat intermediate	(per piani prof. 65 cm) (for worktops depth 65 cm)	77,7	7,7 / 7,75	H081ALP
		(per piani prof. 90 cm) (for worktops depth 90 cm)	77,7	7,7 / 7,75	H0818LP
		(per piani prof. 124 cm) (for worktops depth 124 cm)	77,7	7,7 / 7,75	H0811LP



E1	E2	E4
364	364	401

364	364	401
438	438	483
480	480	529

	METROPOLIS
SP. (cm) TH.(cm)	7,7



Spessore variabile, vedi tabella accanto per lo spessore associato al modello di riferimento
Varying thickness, sees table opposite for the thickness associated to the reference model



Non possibile accostare a basi per Lavastoviglie e Lavatrici
Dishwasher and Washing machine units cannot be placed together

ZOCCOLI

PLINTHS

TIPOLOGIA MATERIALE TYPE OF MATERIAL	COLORI COLOURS	DISPONIBILE NEI MODELLI AVAILABLE IN MODELS
PVC verniciato Painted PVC	A SPECCHIO INOX PIOMBO OPACO NERO SPAZZOLATO	UNIVERSALE UNIVERSAL
	Colori in pronta consegna Available colours	
	BIANCO OPACO TITANIO (PVC)	

TIPOLOGIA MATERIALE TYPE OF MATERIAL	COLORI COLOURS	DISPONIBILE NEI MODELLI AVAILABLE IN MODELS
PVC LACCATO OPACO MATT LACQUERED PVC	OLIVA L0062 CANAPA LAVAREDO BORGOGNA GINEPRO CURCUMA	UNIVERSALE UNIVERSAL
	Tempi di consegna n° 4 settimane dalla conferma dell'ordine For on-demand colours, the delivery time is 4 weeks from the order confirmation	
	MEDITERRANEO TERRA	

TIPOLOGIA MATERIALE TYPE OF MATERIAL	COLORI COLOURS	DISPONIBILE NEI MODELLI AVAILABLE IN MODELS
ALLUMINIO verniciato Painted ALUMINIUM	TITANIO (ALLUMINIO) NERO SPAZZOLATO (ALLUMINIO) BRONZO (ALLUMINIO)	UNIVERSALE UNIVERSAL
	Colori in pronta consegna Available colours	

TIPOLOGIA MATERIALE TYPE OF MATERIAL	COLORI COLOURS	DISPONIBILE NEI MODELLI AVAILABLE IN MODELS
PVC rivestito in carta coated in paper PVC	NERO SPAZZOLATO TITANIO BRONZO	UNIVERSALE UNIVERSAL
	Colori in pronta consegna Available colours	

ARTICOLO ARTICLE	DESCRIZIONE DESCRIPTION	ALTEZZA (cm) HEIGHT (cm)	CODICE CODE	SPECCHIO - INOX (PVC)	BIANCO OPACO - BRONZO (PVC)	PIOMBO OPACO (PVC)	TITANIO (PVC)	NERO SPAZZOLATO - TITANIO (PVC)	PVC LACCATO O.	TITANIO - BRONZO (ALLUMINIO)	NERO SPAZZOLATO (ALLUMINIO)
---------------------	----------------------------	-----------------------------	----------------	-----------------------	-----------------------------	--------------------	---------------	---------------------------------	----------------	------------------------------	-----------------------------

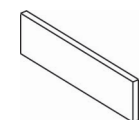

ZOCCOLO PER BASI E COLONNE AL ML.
Lungh. max 400 cm
PLINTH FOR BASE AND TALL UNITS PER LM
Max. length 400 cm

	8	JA00.03	--	10	--	10	10	--	24	24
	10	JA00.00	11	11	11	11	11	46	27	27
NEW	12	JA00.01	12	12	12	12	12	45	27	27
NEW	15	JA00.01	17	17	17	17	17	49	32	32

ZOCCOLI

PLINTHS

ARTICOLO ARTICLE	DESCRIZIONE DESCRIPTION	ALTEZZA (cm) HEIGHT (cm)	CODICE CODE	SPECCHIO - INOX (PVC)	BIANCO OPACO - BRONZO (PVC)	PIOMBO OPACO (PVC)	TITANIO (PVC)	NERO SPAZZOLATO - TITANIO (PVC)	PVC LACCATO O.	TITANIO - BRONZO (ALLUMINIO)	NERO SPAZZOLATO (ALLUMINIO)
	MULTIANGOLO CON SNODO DI RACCORDO MULTI-CORNER PIECE WITH CONNECTION JOINT	8	5FMZ0808..	--	4	--	4	4	--	9	9
		10	5FMZ0108..	4	4	4	4	4	20	17	17



ANGOLARE DI RACCORDO ESTERNO A 90°
90° OUTER CORNER CONNECTION PIECE

8	5FMZ0804..	--	4	--	4	4	4	--	4	4
10	5FMZ0104..	4	4	4	4	4	4	12	4	4



ANGOLARE DI GIUNZIONE A 180°
180° CORNER CONNECTION PIECE

8	5FMZ0803..	--	4	--	4	4	4	--	4	4
10	5FMZ0103..	4	4	4	4	4	4	12	4	4



Elementi da conteggiare necessariamente nelle composizioni con zoccolo LACCATO OPACO
Elements to be calculated in the compositions with MATT LACQUERED plinth

RICAMBI PER ANTE

SPARES FOR DOORS

CERNIERE ESCLUSE NEL PREZZO DELL' ANTA
HINGES IT EXCLUDED IN THE PRICE OF THE DOOR

LARGHEZZA (mm) WIDTH (mm)	ALTEZZA (mm) HEIGHT (mm)	N° CERNIERE SU ANTE BATTENTI N° HINGES FOR DOORS BEATING
147	717	2
147	777	2
147	957	2
147	2037	4
147	2097	4
247	717	2
247	1317	2
260	717	2
260	957	2
276,5	717	2
276,5	957	2
280	717	2
280	957	2
297	169,5	-
297	177	-
297	342	2
297	357	2
297	717	2
297	777	2
297	957	2
297	1092	2
297	1317	2
297	1377	2
297	1557	4
297	2037	4
297	2097	4
NEW 297	2167	4
NEW 297	2337	4
310	717	2
310	957	2
330	717	2
330	957	2
331	717	2
331	777	2
356	717	2
356	777	2
375	717	2
375	957	3
397	169,5	-
397	177	-
397	184,5	-
397	717	2
397	777	2
397	957	2

E1	E2	E4
35	38	46
35	38	46
42	46	58
53	66	115
53	67	122
40	42	52
58	62	90
42	44	59
51	55	78
42	44	60
51	55	79
42	44	60
51	55	80
28	31	40
28	31	40
35	38	45
35	38	45
41	45	62
42	45	65
52	57	81
60	64	91
60	70	93
61	70	108
94	115	126
107	123	151
107	123	163
107	123	163
107	123	168
42	48	65
54	59	83
43	48	67
55	60	87
43	46	68
43	46	69
44	49	68
44	49	74
46	50	69
58	65	90
30	33	43
30	33	43
31	33	43
46	51	71
47	52	79
58	66	91

RICAMBI PER ANTE

SPARES FOR DOORS

CERNIERE ESCLUSE NEL PREZZO DELL' ANTA
HINGES IT EXCLUDED IN THE PRICE OF THE DOOR

LARGHEZZA (mm) WIDTH (mm)	ALTEZZA (mm) HEIGHT (mm)	N° CERNIERE SU ANTE BATTENTI N° HINGES FOR DOORS BEATING
429	717	2
429	957	3
447	117	-
447	169,5	-
447	177	-
447	184,5	-
447	237	2
447	342	2
447	357	2
447	372	2
447	387	2
447	477	2
447	537	2
447	597	2
447	717	2
447	777	2
NEW 447	847	3
447	957	3
447	1077	3
447	1287	3
447	1317	3
447	1377	3
447	1527	4
447	1557	4
447	2037	4
447	2097	4
NEW 447	2167	4
NEW 447	2337	4
557	357	2
597	55,5	-
597	117	-
597	169,5	-
597	177	-
597	184,5	-
NEW 597	222	2
597	237	2
NEW 597	252	2
597	327	2
597	342	2
597	357	2
597	372	2
597	387	2
597	430	2
597	447	2
597	477	2

E1	E2	E4
52	56	77
67	73	96
32	33	37
31	34	44
31	34	44
32	34	44
34	35	45
37	41	52
37	41	52
38	41	54
38	41	54
40	44	60
42	46	62
45	48	67
51	56	78
52	58	85
64	69	101
66	73	97
72	86	114
72	91	125
72	91	125
73	91	142
96	117	130
96	117	130
108	125	231
111	126	234
115	131	234
127	141	238
39	44	62
25	27	34
41	45	59
35	39	48
35	39	48
36	39	48
45	47	55
40	41	50
45	47	55
41	43	65
44	49	63
44	49	63
45	49	67
45	49	67
48	52	67
50	54	70
50	54	70

RICAMBI PER ANTE

SPARES FOR DOORS

CERNIERE ESCLUSE NEL PREZZO DELL' ANTA
HINGES IT EXCLUDED IN THE PRICE OF THE DOOR

LARGHEZZA (mm) WIDTH (mm)	ALTEZZA (mm) HEIGHT (mm)	N° CERNIERE SU ANTE BATTENTI N° HINGES FOR DOORS BEATING
NEW 597	492	2
597	520	2
597	567	2
597	582	2
597	589,5	2
597	597	2
NEW 597	627	2
NEW 597	652	2
597	670	2
597	687	2
597	717	3
597	760	3
597	777	3
NEW 597	847	3
597	927	3
597	957	3
597	1077	3
597	1092	3
597	1287	3
597	1317	3
597	1377	3
597	1527	4
597	1557	4
597	2037	4
597	2097	4
NEW 597	2167	5
NEW 597	2337	5
NEW 647	717	3
NEW 647	957	3
NEW 747	117	-
NEW 747	184,5	-
NEW 747	192	-
NEW 747	222	-
NEW 747	252	-
747	357	2
NEW 747	372	-
NEW 747	387	-
747	477	2
NEW 747	492	-
NEW 747	597	3
NEW 747	627	3
NEW 747	687	3
747	717	3
747	777	3

E1	E2	E4
57	61	79
52	56	71
53	60	87
53	60	93
53	60	93
55	63	80
59	69	91
59	69	91
59	69	81
59	69	91
59	69	91
69	82	92
60	70	110
80	84	125
75	89	117
75	89	117
82	95	142
82	95	142
89	113	154
89	113	154
90	113	183
97	118	156
97	118	156
115	159	233
126	159	271
147	167	284
161	176	304
60	70	113
88	98	148
43	47	61
42	44	53
42	44	53
49	52	62
49	52	62
47	54	75
51	57	78
51	57	78
55	64	85
65	69	94
66	76	105
76	91	123
76	91	123
76	91	123
66	80	134

RICAMBI PER ANTE

SPARES FOR DOORS

CERNIERE ESCLUSE NEL PREZZO DELL' ANTA
HINGES IT EXCLUDED IN THE PRICE OF THE DOOR

LARGHEZZA (mm) WIDTH (mm)	ALTEZZA (mm) HEIGHT (mm)	N° CERNIERE SU ANTE BATTENTI N° HINGES FOR DOORS BEATING
NEW 747	847	3
NEW 747	927	3
NEW 747	957	3
NEW 747	1287	3
747	1317	3
NEW 747	1527	3
NEW 747	1557	3
857	357	-
897	117	-
897	169,5	-
897	177	-
897	184,5	-
NEW 897	222	-
NEW 897	252	-
897	342	-
897	357	-
897	372	-
897	387	-
897	477	-
NEW 897	492	-
897	597	-
NEW 897	627	-
897	717	-
897	777	-
NEW 1197	117	-
1197	169,5	-
1197	177	-
1197	184,5	-
NEW 1197	222	-
NEW 1197	252	-
1197	342	-
1197	357	-
1197	372	-
1197	477	-
NEW 1197	492	-
1197	597	-
1497	357	-
1497	477	-
1797	357	-
1797	477	-
2097	357	-
2097	477	-
2397	357	-
2397	477	-

E1	E2	E4
86	97	149
94	104	164
94	104	164
143	145	217
143	145	217
122	148	248
122	148	248
49	56	80
43	49	61
42	45	56
42	45	56
43	45	58
53	55	69
53	55	69
51	58	80
51	58	80
52	58	89
52	58	89
57	69	91
73	77	108
67	79	106
79	92	131
76	93	123
76	93	154
49	51	63
47	50	64
47	50	64
48	50	70
61	63	85
61	63	85
60	71	97
60	71	97
61	71	109
71	90	115
81	91	136
80	101	134
72	74	125
85	92	157
81	83	145
97	99	189
91	93	163
109	114	201
101	103	185
122	128	227

MAGGIORAZIONI PER ELEMENTI FUORI MISURA

SURCHARGES FOR NON-STANDARD ELEMENTS

LE MAGGIORAZIONI RIPORTATE NELLA TABELLA SOTTOSTANTE DEVONO ESSERE SOMMATE AL PREZZO DELL' ELEMENTO DI SERIE PIÙ GRANDE RISPETTO A QUELLO DELLE DIMENSIONI RICHIESTE;
MAGGIORAZIONE RIFERITA SOLO PER MOBILI, NO SU ANTA
THE SURCHARGES INDICATED IN THE TABLE BELOW SHOULD BE ADDED TO THE PRICE OF THE LARGEST STANDARD ELEMENT WITH RESPECT TO THE DIMENSIONS REQUESTED;
SURCHARGE FOR UNIT ONLY, NOT ON DOOR

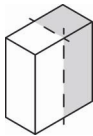
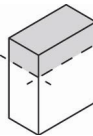
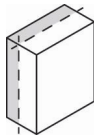
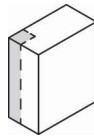
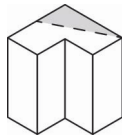
STRUTTURA STRUCTURE	RIDUZIONE IN LARGHEZZA REDUCTION IN WIDTH	RIDUZIONE IN ALTEZZA REDUCTION IN HEIGHT	RIDUZIONE IN PROFONDITÀ REDUCTION IN DEPTH	SCANSO PILASTRO PILLAR CUTS	FUORI SQUADRO OUT OF SQUARE
					
BASI BASE UNITS	+ 85	+ 85	+ 75	+ 115	+ 115
PENSILI WALL UNITS	+ 80	+ 80	+ 70	+ 105	+ 110
COLONNE TALL UNITS	+ 125	+ 125	+ 115	+ 120	+ 140

IN PRESENZA DI PIÙ MODIFICHE DA APPLICARE NELLO STESSO ELEMENTO (ES. LARGHEZZA E ALTEZZA) LA MAGGIORAZIONE È DATA DALLA LORO SOMMA
IN THE PRESENCE OF SEVERAL MODIFICATIONS TO APPLY TO THE SAME ELEMENT (EG. WIDTH AND HEIGHT) THE SURCHARGE IS GIVEN BY THEIR SUM

MAGGIORAZIONI PER TAGLI DI RIFILATURA SU ANTA

SURCHARGES FOR TRIMMING CUTS ON THE DOOR

MAGGIORAZIONE DA SOMMARE OBBLIGATORIAMENTE PER OGNI TAGLIO SU ANTA
SURCHARGE MUST BE ADDED FOR EACH CUT ON THE DOOR

	LAMINATO LAMINATED	IMPIALLACCIATO / LEGNO VENEERED / WOOD
MAGGIORAZIONE SURCHARGE	+ 25	+ 50

- TUTTE LE ANTE RIFILATE SARANNO CONSEGNATE SENZA FORO MANIGLIA

- SI FA PRESENTE CHE NON TUTTI I MODELLI SONO RIFILABILI, IN ALCUNI NON È POSSIBILE QUESTO TIPO DI LAVORAZIONE PERCHÈ IL MATERIALE, LA VERNICE O LA TIPOLOGIA NON LO RENDE POSSIBILE;
PRENDERE COME RIFERIMENTO LA PRIMA PAGINA DI OGNI MODELLO "CARATTERISTICHE TECNICHE" PER QUESTO TIPO DI INFORMAZIONE

- ALL TRIMMED DOORS WILL BE DELIVERED WITHOUT HANDLE HOLE

- PLEASE NOTE THAT NOT ALL MODELS ARE TRIMMABLE, FOR SOME THIS TYPE OF MACHINING IS NOT POSSIBLE BECAUSE THE MATERIAL, THE PAINT OR THE TYPE DOES NOT MAKE IT POSSIBLE;
TAKE THE FIRST PAGE OF EACH MODEL "TECHNICAL CHARACTERISTICS" AS REFERENCE FOR THIS KIND OF INFORMATION

MAGGIORAZIONI PER LAVORAZIONI VARIE

SURCHARGES FOR VARIOUS MACHINING OPERATIONS

MAGGIORAZIONE SURCHARGE	PTS.
<p>ELEMENTO SMONTATO, si possono realizzare tutti gli elementi smontati ad eccezione dei moduli con cassetti e cesti che non è possibile fornire smontati</p> <p>DISASSEMBLED ELEMENT, all elements can be made disassembled with the exception of modules with drawers and deep-pan drawers that can not be supplied disassembled</p>	<p>NESSUNA MAGGIORAZIONE NO SURCHARGE</p>
<p>BASE PREDISPOSTA PER PIANO COTTURA, da applicare su ogni base dove alloggerà il piano cottura, ad esclusione della base forno che è prevista di serie</p> <p>BASE UN ITS PREPARED FOR HOB, to apply to each base unit in which the hob is housed, excluding the oven base unit that comes prepared as standard</p>	<p>+ 10</p>
<p>BASE USO PENISOLA, da applicare quando la base deve essere predisposta per fissaggio ante retro uso bancone</p> <p>PENINSULA BASE UNIT, to apply when the base unit has to be prepared for the application of rear doors for counter use</p>	<p>+ 25</p>
<p>COLONNA NON STANDARD PREDISPOSTA PER ELETTRODOMESTICO DEL CLIENTE NON A LISTINO STOSA NON-STANDARD TALL UNIT PREPARED FOR THE CUSTOMER'S APPLIANCE NOT IN THE STOSA PRICE LIST</p>	<p>+ 140</p>
<p>CASSETTI/CESTI MENO PROFONDI SU BASI CON PROFONDITÀ DI SERIE, da applicare quando viene richiesta la modifica della sola profondità dei cassetti/cesti interni e la base resterà di serie</p> <p>REDUCED DEPTH DRAWERS/DEEP-PAN DRAWER ON BASE UNITS WITH STANDARD DEPTHS, to apply when the modification of the internal drawers/deep-pan drawers depth only is required and the base unit remains standard</p>	<p>+ 10</p>
<p>COLONNA CON PREDISPOSIZIONE COPRIBOILER TALL UNIT PREPARED FOR BOILER HOUSING</p>	<p>+ 50</p>
<p>PREDISPOSIZIONE CAPPА CLIENTE CUSTOMER'S HOOD PREPARATION</p>	<p>+ 50</p>
<p>PASSAGGIO TUBO CAPPА SU PENSILE SUPERIORE, da applicare quando si richiede il passaggio del solo tubo cappa su un pensile standard</p> <p>HOOD PIPE PASSAGE ON UPPER WALL UNITS, to apply when the passage of the hood pipe only is required on a standard wall unit</p>	<p>+ 35</p>

- IN PRESENZA DI PIÙ MODIFICHE DA APPLICARE NELLO STESSO ELEMENTO (ES. LARGHEZZA E ALTEZZA) LA MAGGIORAZIONE È DATA DALLA LORO SOMMA
- PER FUORI MISURA NON PREVISTI E SPECIFICATI NEL PRESENTE LISTINO, SI DOVRÀ EFFETTUARE LA RICHIESTA DI FATTIBILITÀ E PREVENTIVO ALL' UFFICIO COMMERCIALE STOSA
- IN THE PRESENCE OF SEVERAL MODIFICATIONS TO APPLY TO THE SAME ELEMENT (EG. WIDTH AND HEIGHT) THE SURCHARGE IS GIVEN BY THEIR SUM
- FOR NON-STANDARD ELEMENTS NOT FORESEEN AND SPECIFIED IN THIS PRICE LIST, A REQUEST OF FEASIBILITY AND QUOTATION MUST BE MADE TO THE STOSA SALES DEPARTMENT

REGOLE ED ACCORGIMENTI PER ELEMENTI A MISURA/LAVORAZIONI

REGULATIONS AND ADJUSTMENTS FOR MADE TO MEASURE/MACHINED ELEMENTS

RIDUZIONI REDUCTIONS

- GLI ELEMENTI CON CASSETTI/CESTI POSSONO ESSERE RIDOTTI IN PROFONDITÀ FINO A 30 CM AL FIANCO, GARANTENDO LA CHIUSURA AMMORTIZZATA DEI FRONTALI.

- CON LA RIDUZIONE DI MODULI CASSETTI/CESTI, LE GUIDE VERRANNO ADATTATE IN BASE ALLA PROFONDITÀ DEL FIANCO.

- TUTTI I MODULI CON ANTE BATTENTI POSSONO ESSERE RIDOTTI FINO AD UNA PROFONDITÀ MINIMA DI 10 CM AL FIANCO, AD ESCLUSIONE DI QUELLI CON MECCANISMI INTERNI E PER ELETTRODOMESTICI.

- GLI SCOLAPIATTI POSSONO ESSERE RIDOTTI IN LARGHEZZA CON CONSEGUENTE PERDITA DELLA VASCHETTA INTERNA RACCOGLI GOCCIE IN PVC CHE NON VERRÀ FORNITA CON IL MOBILE.

- ELEMENTS WITH DRAWERS/ DEEP-PAN DRAWERS CAN BE REDUCED IN DEPTH UP TO 30 CM ON THE SIDE, ENSURING THE CLOSE OF SUSPENSION OF THE FRONT.

- WITH THE REDUCTION OF DRAWER/DEEP-PAN DRAWER MODULES, THE GUIDES WILL BE ADAPTED ACCORDING TO THE DEPTH OF THE SIDE.

- ALL MODULES WITH HINGED DOORS CAN BE REDUCED TO AT A DEPTH OF AT LEAST 10 CM ON THE SIDE, EXCEPT THOSE WITH INTERNAL MECHANISMS AND APPLIANCES.

- THE PLATE RACKS CAN BE REDUCED IN WIDTH WITH CONSEQUENT LOSS OF THE INTERNAL PVC DRIP TRAY THAT WILL NOT SUPPLIED WITH THE UNIT.

FUORI SQUADRO OUT OF SQUARE

- IL MOBILE FUORI SQUADRO, SE NON ESPRESSAMENTE RICHIESTO, NON VIENE REALIZZATO PER GLI ANGOLI COMPRESI TRA 89° E 91° E QUINDI NON È SOGGETTO A MAGGIORAZIONI. IL TOP VIENE LAVORATO A QUALSIASI GRADAZIONE RICHIESTA.

- PER UNA CORRETTA REALIZZAZIONE DI UN ELEMENTO FUORI SQUADRA È INDISPENSABILE RICEVERE LA MISURA DELL' ANGOLO ESPRESSO IN GRADI DECIMALI (ES. 80,5°) O LA LUNGHEZZA DELLA DIAGONALE DELTRIANGOLO CON LATO 100 X 100

- OUT OF SQUARE UNITS, UNLESS SPECIFICALLY REQUESTED, WILL NOT BE MADE FOR ANGLES BETWEEN 89° AND 91° AND THEREFORE IS NOT SUBJECT TO SURCHARGES. THE WORKTOP IS MACHINED AT ANY ANGLE REQUIRED.

- FOR THE CORRECT CONSTRUCTION OF AN OUT OF SQUARE ELEMENT, THE FOLLOWING ARE REQUIRED ANGLE EXPRESSED IN DEGREES (E.G. 80.5°) OR THE LENGTH OF THE DIAGONAL SIDE OF THE 100 X 100 TRIANGLE

AVVERTENZE ELETTRODOMESTICI HOUSEHOLD APPLIANCE WARNINGS

- È DOVEROSO RISPETTARE I CRITERI DI INSTALLAZIONE PREVISTI DAI PRODUTTORI DELLE RELATIVE CASE PRODUTTRICI DI ELETTRODOMESTICI SPECIFICATI NEGLI APPOSITI LIBRETTI "ISTRUZIONI/INSTALLAZIONE".

- È NECESSARIO L' INSERIMENTO DI UN EVENTUALE "SETTO SEPARATORE" NELLE BASI PREDISPOSTE PER PIANI COTTURA; AL FINE DI ISOLARE IL CALORE DALLE PARTI ACCESSIBILI INTERNE. PER "SETTO SEPARATORE" SI INTENDE UN RIPIANO MOBILE BASE IN AGGIUNTA. TALE RIPIANO NON VIENE FORNITO DA STOSA SE NON RICHIESTO ESPRESSAMENTE AL MOMENTO DELL' ORDINE, NON NECESSARIO PER BASI PREDISPOSTE PER INCASSO FORNO.

- THE INSTALLATION CRITERIA PROVIDED BY THE HOUSEHOLD APPLIANCE MANUFACTURERS SPECIFIED IN THE RELATED "INSTRUCTION / INSTALLATION" BOOKLET, MUST BE RESPECTED.

- IT IS NECESSARY TO INSERT AN EVENTUAL "SEPARATOR SEPT" IN THE BASES PREPARED FOR COOKING HOBS; IN ORDER TO ISOLATE THE HEAT FROM THE INTERIOR PARTS AVAILABLE. FOR "SETTO SEPARATOR" IS A MOBILE BASE SHELF IN ADDITION. THE SHELF IS NOT PROVIDED BY STOSA EXPRESSLY UNLESS REQUIRED AT THE TIME OF ORDER, NOT NECESSARY TO BASE PREPARED FOR BUILT OVEN.

REGOLE ED ACCORGIMENTI PER ELEMENTI A MISURA/LAVORAZIONI

REGULATIONS AND ADJUSTMENTS FOR MADE TO MEASURE/MACHINED ELEMENTS

TAGLI DI RIFILATURA SU ANTA TRIMMING CUTS ON THE DOOR

TUTTE LE RIDUZIONI ALTERANO L' ESTETICA DEL FRONTALE, IL RISULTATO QUALITATIVO È INFERIORE A QUELLO DI SERIE, PERTANTO NON POTRÀ ESSERE OGGETTO DI CONTESTAZIONE

ALL REDUCTIONS ALTER THE LOOK OF THE FRONT, THE QUALITATIVE RESULT IS LOWER THAN THE STANDARD, THEREFORE IT CANNOT BE DISPUTED

TIPOLOGIA FRONTALE: TYPE OF FRONT:	METODO DI RIFILATURA: TRIMMING METHOD:
ANTA LISCIA CON LATI STONDATI POSTFORMATI E PARTE SUPERIORE E INFERIORE DRITTA SMOOTH DOOR WITH POST-FORMED ROUNDED SIDES AND STRAIGHT TOP AND BOTTOM	IL FRONTALE VIENE TAGLIATO E RIBORDATO CON BORDO ABS CON CONSEGUENTE PERDITA DELLA PARTE STONDATA CHE DIVENTERÀ DRITTA - Per ante battenti il taglio verrà realizzato lato cerniere - Per ante con altri tipi di aperture il taglio verrà realizzato in entrambi i lati con perdita di entrambe le stonature THE FRONT IS CUT AND RE-EDGED WITH ABS EDGING RESULTING IN THE LOSS OF THE ROUNDED SECTION THAT BECOMES STRAIGHT - For hinged doors, the cut is made on the hinged side - For doors with different types of opening, the cut is made on both sides with the loss of both rounded edges
ANTA A TELAIO FRAMED DOOR	IL FRONTALE VIENE RIDOTTO RIFILANDO LATERALMENTE I LATI SECONDO I PARAMETRI RIPORTATI NELLA PRIMA PAGINA DI OGNI MODELLO "CARATTERISTICHE TECNICHE". CON CONSEGUENTE PERDITA DI ALCUNI MM DEL TELAIO ESTERNAMENTE E DIFFERENTE MISURA ESTETICA RISPETTO A FRONTALI DI SERIE. THE FRONT IS REDUCED BY LATERALLY TRIMMING THE SIDES ACCORDING TO THE PARAMETERS INDICATED ON THE FIRST PAGE OF EACH MODEL "TECHNICAL CHARACTERISTICS", RESULTING IN THE LOSS OF A FEW MM ON THE FRAME EXTERNALLY AND DIFFERENT AESTHETICS WITH RESPECT TO STANDARD FRONTS.

AVVERTENZE WARNINGS

ATTENZIONE!

- Per composizioni ordinate prive di elettrodomestici è prevista una **MAGGIORAZIONE di PTS. 200 + IVA**. Tale direttiva non si applica se la cucina contiene almeno n° 2 elettrodomestici.
- Per composizioni ordinate prive di TOPS è prevista una **MAGGIORAZIONE di PTS. 100 + IVA**.
- Addebiti corrieri a carico del cliente pari a un 3% imponibile fattura, laddove il cliente richiede lo scarico presso deposito per cause non imputabile a Stosa.

Attention!

- For compositions ordered without appliances, a **SURCHARGE of PTS. 200 + VAT** is forseen. This directive is not applied if the kitchen contains at least 2 appliances.
- For compositions ordered without WORKTOPS, a **SURCHARGE of PTS. 100 + VAT** is forseen.
- Courier charges borne by the customer equal to a 3% taxable amount on invoice, if the customer requires unloading at warehouse for reasons not attributable to Stosa.

CASSETTI / CESTI NOVAPRO SCALA

NOVAPRO SCALA DRAWER / DEEP-PAN DRAWER

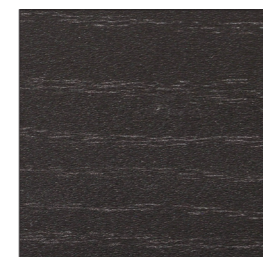
FINITURE SPONDE + FONDO
SIDE + BOTTOM FINISHESsponda TITANIO
+
fondo TITANIO
effetto Pellesponda STONE
+
fondo STONE
effetto Pellesponda BIANCA
+
fondo BIANCOFINITURE COVER
COVER FINISHESTITANIO
effetto PelleSTONE
effetto PelleBIANCO
FRASSINO

NERO FRASSINO

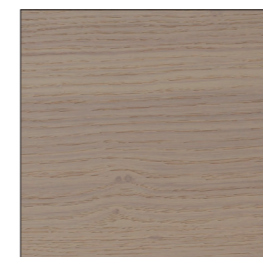

ROVERE NORDIC



ROVERE NODATO

ROVERE
DESERTO

CASSETTI / CESTI NOVAPRO SCALA

NOVAPRO SCALA DRAWER / DEEP-PAN DRAWER

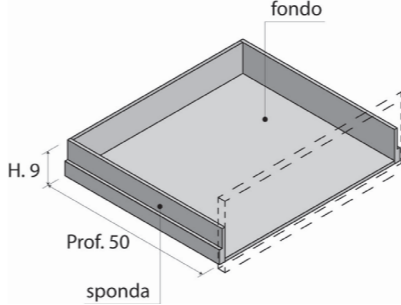
ARTICOLO ARTICLE	DESCRIZIONE DESCRIPTION	PR. (cm) D. (cm)	L. (cm) W. (cm)	CODICE CODE	PTS.	
	RICAMBIO CASSETTO NOVAPRO SCALA H. 9 cm, per basi prof. 40 - 50 - 60 cm Abbinamento colori: - sponde colore TITANIO con fondo TITANIO effetto pelle - sponde colore STONE con fondo STONE effetto pelle - sponde colore BIANCO con fondo BIANCO REPLACEMENT NOVAPRO SCALA DRAWER H. 9 cm, for base units Depth 40 - 50 - 60 cm Color combination: - TITANIO coloured sides, TITANIO leather effect bottom - STONE coloured sides, STONE leather effect bottom - BIANCO coloured sides, BIANCO leather	40	30	5AFG000CA0	55	
		40	40	5AFG000CA1	56	
		40	45	5AFG000CA2	57	
		40	60	5AFG000CA4	58	
		NEW	40	75	5AFG000CAB	66
		40	90	5AFG000CA6	67	
		NEW	40	105	5AFG000CAA	74
		40	120	5AFG000CA8	79	
		50	30	5AFG000CA0	55	
		50	40	5AFG000CA1	56	
50	45	5AFG000CA2	57			
50	60	5AFG000CA4	58			
NEW	50	75	5AFG000CAB	66		
50	90	5AFG000CA6	67			
NEW	50	105	5AFG000CAA	74		
50	120	5AFG000CA8	79			
60	30	5AFG000CA0	95			
60	40	5AFG000CA1	96			
60	45	5AFG000CA2	97			
60	60	5AFG000CA4	98			
NEW	60	75	5AFG000CAB	104		
60	90	5AFG000CA6	107			
NEW	60	105	5AFG000CAA	112		
60	120	5AFG000CA8	119			

ARTICOLO MONTATO DI SERIE
IN TUTTE LE BASI - COLONNE
CON CASSETTI

ARTICLE OF SERIES
MOUNTED
IN ALL THE BASES -
COLUMNS
WITH DRAWER

CASSETTI / CESTI NOVAPRO SCALA

NOVAPRO SCALA DRAWER / DEEP-PAN DRAWER

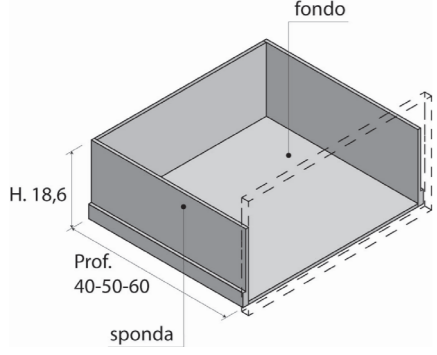
ARTICOLO ARTICLE	DESCRIZIONE DESCRIPTION	PR. (cm) D. (cm)	L. (cm) W. (cm)	CODICE CODE	PTS.
 <p>RICAMBIO CESTO NOVAPRO SCALA H. 18,6 cm, per basi prof. 40 - 50 - 60 cm Abbinamento colori: - sponde colore TITANIO con fondo TITANIO effetto pelle - sponde colore STONE con fondo STONE effetto pelle - sponde colore BIANCO con fondo BIANCO</p> <p>REPLACEMENT NOVAPRO SCALA DEEP-PAN DRAWER H. 18,6 cm, for base units Depth 40 - 50 - 60 cm Color combination: - TITANIO coloured sides, TITANIO leather effect bottom - STONE coloured sides, STONE leather effect bottom - BIANCO coloured sides, BIANCO leather</p> <p>ARTICOLO MONTATO DI SERIE IN TUTTE LE BASI - COLONNE CON CESTI</p> <p>ARTICLE OF SERIES MOUNTED IN ALL THE BASES - COLUMNS WITH DEEP-PAN DRAWER</p>		40	30	5AFG000CE0	95
		40	45	5AFG000CE2	96
		40	60	5AFG000CE4	96
	NEW	40	75	5AFG000CEB	100
		40	90	5AFG000CE6	104
	NEW	40	105	5AFG000CEA	118
		40	120	5AFG000CE8	152
		50	30	5AFG000CE0	95
		50	45	5AFG000CE2	96
		50	60	5AFG000CE4	98
	NEW	50	75	5AFG000CEB	100
		50	90	5AFG000CE6	104
NEW	50	105	5AFG000CEA	118	
	50	120	5AFG000CE8	152	
	60	30	5AFG000CE0	140	
	60	45	5AFG000CE2	141	
	60	60	5AFG000CE4	143	
NEW	60	75	5AFG000CEB	145	
	60	90	5AFG000CE6	149	
NEW	60	105	5AFG000CEA	175	
	60	120	5AFG000CE8	197	

CASSETTI / CESTI NOVAPRO SCALA

NOVAPRO SCALA DRAWER / DEEP-PAN DRAWER

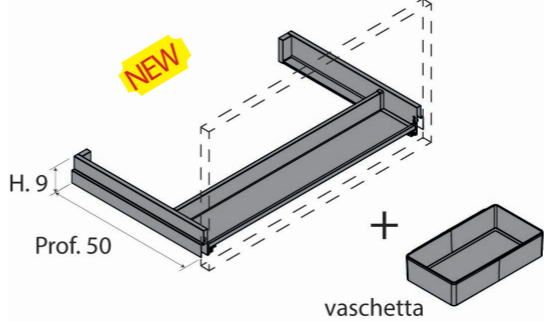
ARTICOLO ARTICLE	DESCRIZIONE DESCRIPTION	L. (cm) W. (cm)	CODICE CODE	PTS.
 <p>RICAMBIO CESTO SOTTOLAVELLO SUPERIORE NOVAPRO SCALA H. 9 cm, per basi sottolavello prof. 50 cm colori: TITANIO, STONE, BIANCO. + Vaschetta nei colori STONE, TITANIO • per L. 60, max n° 2 vaschette • per L. 75, max n° 2 vaschette • per L. 90, max n° 3 vaschette • per L. 120, max n° 3 vaschette</p> <p>REPLACEMENT NOVAPRO SCALA DEEP-PAN DRAWER H. 9 cm FOR SINK UNIT, for sink units Depth 50 cm Color: TITANIO, STONE, BIANCO. + Tray in the colors STONE, TITANIO • for L. 60, max n° 2 trays • for L. 75, max n° 2 trays • for L. 90, max n° 3 trays • for L. 120, max n° 3 trays</p> <p>ARTICOLO MONTATO DI SERIE IN TUTTE LE BASI SOTTOLAVELLO CON 2 CESTI ESTRAIBILI</p> <p>ARTICLE OF SERIES MOUNTED IN ALL BASES sink with 2 pull-out baskets</p>		60	5AFG00SCL5	125
		75	5AFG00SCL9	130
		90	5AFG00SCL6	135
		120	5AFG00SCL8	180
		50	30	5AFG000CE0
	50	45	5AFG000CE2	96
	50	60	5AFG000CE4	98
NEW	50	75	5AFG000CEB	100
	50	90	5AFG000CE6	104
NEW	50	105	5AFG000CEA	118
	50	120	5AFG000CE8	152
	60	30	5AFG000CB4	50
	90	5AFG000CB6	59	
NEW	75	5AFG000CBB	65	
	60	30	5AFG000CE0	140
	60	45	5AFG000CE2	141
	60	60	5AFG000CE4	143
NEW	60	75	5AFG000CEB	145
	60	90	5AFG000CE6	149
NEW	60	105	5AFG000CEA	175
	60	120	5AFG000CE8	197
				+ 55

CASSETTI / CESTI NOVAPRO SCALA

NOVAPRO SCALA DRAWER / DEEP-PAN DRAWER

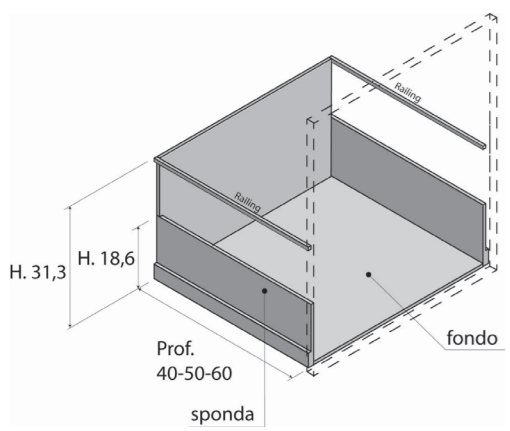
ARTICOLO ARTICLE	DESCRIZIONE DESCRIPTION	PR. (cm) D. (cm)	L. (cm) W. (cm)	CODICE CODE	PTS.
 <p>RICAMBIO CESTO NOVAPRO SCALA H. 18,6 cm CON RAILING, per basi prof. 50 cm</p> <p>REPLACEMENT NOVAPRO SCALA DEEP-PAN DRAWER H. 18,6 cm WITH RAILING, for base units Depth 50 cm</p> <p>ARTICOLO MONTATO DI SERIE IN TUTTE LE BASI - COLONNE CON CESTI SU ANTE H. 77,7</p> <p>ARTICLE OF SERIES MOUNTED IN ALL THE BASES - COLUMNS WITH DEEP-PAN DRAWER WITH DOORS H. 77,7</p>					
		40	45	5AFG00CCE2	97
		40	60	5AFG00CCE4	99
	NEW	40	75	5AFG00CCE5	104
		40	90	5AFG00CCE6	109
		50	45	5AFG00CCE2	97
		50	60	5AFG00CCE4	99
	NEW	50	75	5AFG00CCE5	104
		50	90	5AFG00CCE6	109
		60	45	5AFG00CCE2	142
		60	60	5AFG00CCE4	144
	NEW	60	74	5AFG00CCE5	149
	60	90	5AFG00CCE6	154	

CASSETTI / CESTI NOVAPRO SCALA

NOVAPRO SCALA DRAWER / DEEP-PAN DRAWER

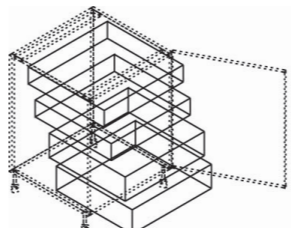
ARTICOLO ARTICLE	DESCRIZIONE DESCRIPTION	PR. (cm) D. (cm)	L. (cm) W. (cm)	PTS.
 <p>MAGGIORAZIONE PER CASSETTI E CESTI INTERNI CON GUIDE AMMORTIZZATE (Opzionale con maggiorazione)</p> <p>A richiesta il cassetto si può inserire su tutti i moduli di nostra produzione larghi 45, 60, 90, 120 cm con anta battente, le cerniere delle ante verranno automaticamente cambiate con cerniere a 180°, che permettono l'estrazione dell'elemento</p> <p>INDICAZIONI TECNICHE:</p> <ul style="list-style-type: none"> - non inserire a ridosso di muri e basi angolo - nel caso di inserimento di basi con cassetti o cesti interni a ridosso di basi con corpo sporgente, lasciare uno spazio minimo di 5 cm <p>Cassetto e cesto interno disponibile di colore completamente Titanio, Stone, Bianco Available internal drawers and deep-pan drawers completely Titanio, Stone, Bianco</p> <p>ANTE CON CERNIERE APERTURA 180° POSSIBILITÀ DI INSERIMENTO NELLE VARIE ALTEZZE E TIPOLOGIA n° 4 cassetti interni n° 2 cassetti interni + cesto interno n° 2 cesti interni</p> <p>SURCHARGE FOR INTERNAL DRAWERS AND DEEP-PAN DRAWERS WITH SOFT CLOSE GUIDES (Optional with surcharge)</p> <p>On request, the drawer can be inserted on all modules of our production width 45, 60, 90, 120 cm with hinged door, the hinges of the doors will be automatically changed with 180° hinges, which allow the extraction of the element</p> <p>TECHNICAL INFORMATION:</p> <ul style="list-style-type: none"> - do not insert next to walls and corner base units - in the event of base units with internal drawers or deep-pan drawers next to base units with protruding sections, leave a gap of at least 5 cm <p>DOORS WITH 180° OPENING HINGES, POSSIBILITY OF INCLUSION IN THE VARIOUS HEIGHTS AND TYPES 4 internal drawers 2 internal drawers + internal deep-pan drawer 2 internal deep-pan drawers</p>				
		40	45	+ 74
		40	60	+ 69
	n° 1 cassetto interno 1 internal drawer	40	NEW 75	+ 91
		40	90	+ 92
		40	120	+ 124
		40	45	+ 107
		40	60	+ 114
	n° 1 cesto interno 1 internal deep-pan drawer	40	NEW 75	+ 133
		40	90	+ 134
		40	120	+ 160
		50	45	+ 74
		50	60	+ 69
	n° 1 cassetto interno 1 internal drawer	50	NEW 75	+ 91
		50	90	+ 92
		50	120	+ 124
		50	45	+ 107
	n° 1 cesto interno 1 internal deep-pan drawer	50	60	+ 114
		50	NEW 75	+ 133
		50	90	+ 134
		50	120	+ 160
		60	45	+ 114
		60	60	+ 109
	n° 1 cassetto interno 1 internal drawer	60	NEW 75	+ 131
	60	90	+ 132	
	60	120	+ 154	
	60	45	+ 152	
	60	60	+ 159	
n° 1 cesto interno 1 internal deep-pan drawer	60	NEW 75	+ 178	
	60	90	+ 179	
	60	120	+ 205	

CASSETTI / CESTI NOVAPRO SCALA

NOVAPRO SCALA DRAWER / DEEP-PAN DRAWER

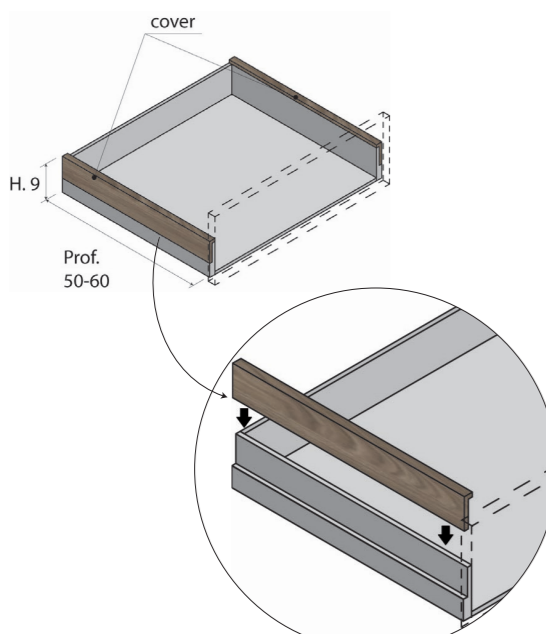
ARTICOLO ARTICLE	DESCRIZIONE DESCRIPTION	PR. (cm) D. (cm)	PTS.
	MAGGIORAZIONE PER COVER MAGNETICA IN APPLICAZIONE ALLE SPONDE, n° 2 PER CASSETTO NOVAPRO SCALA H. 9 CM; PROF. 40 - 50 - 60 CM SURCHARGE FOR MAGNETIC COVER FOR APPLICATION TO THE SIDES, 2 FOR NOVAPRO SCALA DRAWER H. 9 CM; DEPTH 40 - 50 - 60 CM	TITANIO EFFETTO PELLE	50 + 34
		STONE EFFETTO PELLE	50 + 34
		BIANCO FRASSINO	50 + 34
		NERO FRASSINO	50 + 34
		ROVERE NORDIC	50 + 34
		ROVERE NODATO	50 + 34
		ROVERE DESERTO	50 + 34
		TITANIO EFFETTO PELLE	60 + 44
		STONE EFFETTO PELLE	60 + 44

	MAGGIORAZIONE PER COVER MAGNETICA IN APPLICAZIONE ALLE SPONDE, n° 2 PER CESTO NOVAPRO SCALA H. 18,6 cm; PROF. 40 - 50 - 60 CM SURCHARGE FOR MAGNETIC COVER FOR APPLICATION TO THE SIDES, 2 FOR NOVAPRO SCALA DEEP-PAN DRAWER H. 18,6 CM; DEPTH 40 - 50 - 60 CM	TITANIO EFFETTO PELLE	50 + 46
		STONE EFFETTO PELLE	50 + 46
		BIANCO FRASSINO	50 + 46
		NERO FRASSINO	50 + 46
		ROVERE NORDIC	50 + 46
		ROVERE NODATO	50 + 46
		ROVERE DESERTO	50 + 46
		TITANIO EFFETTO PELLE	60 + 56
		STONE EFFETTO PELLE	60 + 56

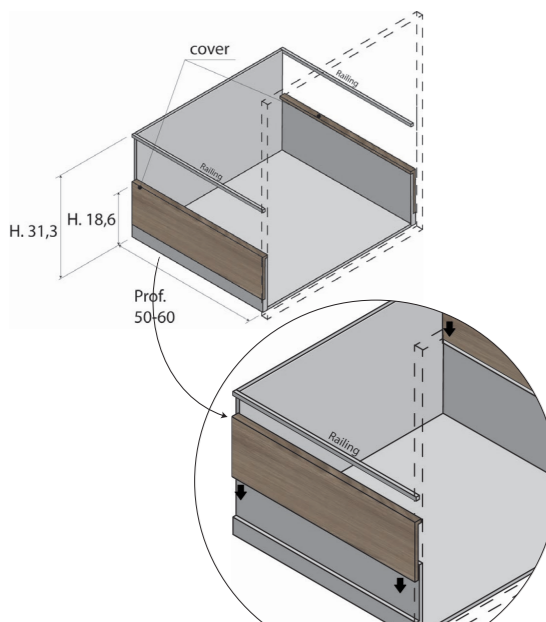
	MAGGIORAZIONE PER COVER MAGNETICA IN APPLICAZIONE ALLE SPONDE, n° 2 PER CESTO NOVAPRO SCALA H. 18,6 cm; PROF. 40 - 50 - 60 CM SURCHARGE FOR MAGNETIC COVER FOR APPLICATION TO THE SIDES, 2 FOR NOVAPRO SCALA DEEP-PAN DRAWER H. 18,6 CM; DEPTH 40 - 50 - 60 CM	TITANIO EFFETTO PELLE	50 + 46
		STONE EFFETTO PELLE	50 + 46
		BIANCO FRASSINO	50 + 46
		NERO FRASSINO	50 + 46
		ROVERE NORDIC	50 + 46
		ROVERE NODATO	50 + 46
		ROVERE DESERTO	50 + 46
		TITANIO EFFETTO PELLE	60 + 56
		STONE EFFETTO PELLE	60 + 56

MAGGIORAZIONI PER SISTEMI DI APERTURA

SURCHARGES FOR OPENING SYSTEMS

ARTICOLO ARTICLE	MAGGIORAZIONE SURCHARGE	PR. (cm) D. (cm)	PTS.
	GUIDA PUSH/PULL PER FRONTALI SENZA MANIGLIE PUSH/PULL GUIDE FOR FRONTS WITHOUT HANDLE	DA 50 KG OF 50 KG	40 + 52
		DA 50 KG OF 50 KG	50 + 52
		DA 70 KG OF 70 KG	60 + 52



ARTICOLO ARTICLE	MAGGIORAZIONE SURCHARGE	PTS.
	SISTEMA DI SICUREZZA ANTISGANCIO PER BAMBINI CHILD PROOF SAFETY CATCH SYSTEM Cod. 800G000B01	13

	SISTEMA DI APERTURA PREMI/APRI, per ante con apertura a 90° Consente l'apertura dell'anta battente Dx e Sx senza la maniglia REGOLE DI APPLICAZIONE: - il sistema di apertura Premi/Apri è un optional per tutte le basi, pensili e colonne con anta battente, quindi inseribile solamente a richiesta la dove non previsto di serie - si specifica che quando viene richiesta una ARTICOLO con Premi/Apri verrà fornita sempre la maniglia a parte, senza fori sull'anta PUSH/PULL OPENING SYSTEM, for doors with 90° opening. Allows the opening of the right and left hinged door without the handle APPLICATION RULES: - the Push/Pull opening system is an optional for all base units, wall units and tall units with hinged door, therefore inserted on request only where not provided as standard - please note that when an ARTICOLO with Push/Pull is requested, the handle is always supplied separate without holes on the door	CHAMPAGNE Cad. 1 Each	+ 21
		ANTRACITE Cad. 1 Each	+ 21

CHAMPAGNE ANTRACITE

MAGGIORAZIONI PER SISTEMI DI APERTURA

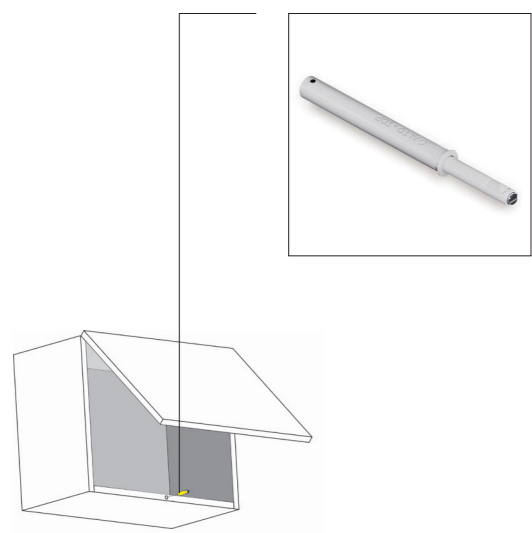
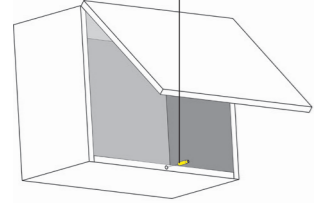
SURCHARGES FOR OPENING SYSTEMS

ARTICOLO ARTICLE	MAGGIORAZIONE SURCHARGE	PTS.
	SISTEMA DI APERTURA PREMI/APRI, per ante con apertura vasistas e battente Consente l'apertura dell'anta battente Dx e Sx senza la maniglia	CHAMPAGNE Cad. 1 Each + 25
	REGOLE DI APPLICAZIONE: - il sistema di apertura Premi/Apri è un optional per tutte le basi, pensili e colonne con anta battente, quindi inseribile solamente a richiesta la dove non previsto di serie - si specifica che quando viene richiesta una ARTICOLO con Premi/Apri verrà fornita sempre la maniglia a parte, senza fori sull'anta	ANTRACITE Cad. 1 Each + 25
	PUSH/PULL OPENING SYSTEM, for lift-up and hinged doors Allows the opening of the right and left hinged door without the handle	
	APPLICATION RULES: - the Push/Pull opening system is an optional for all base units, wall units and tall units with hinged door, therefore inserted on request only where not provided as standard - please note that when an ARTICOLO with Push/Pull is requested, the handle is always supplied separate without holes on the door	

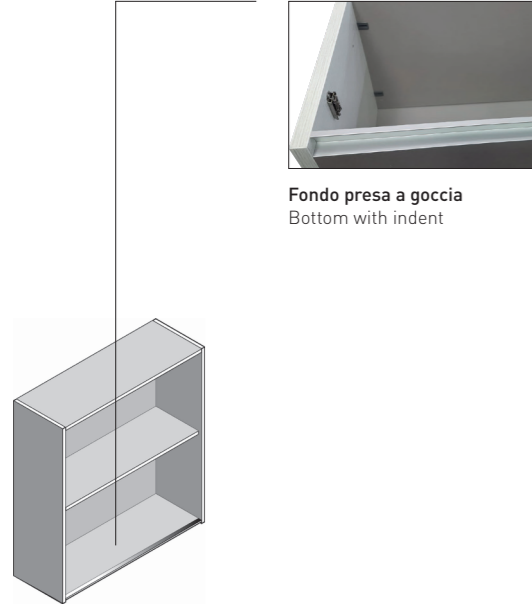
ARTICOLO ARTICLE	MAGGIORAZIONE SURCHARGE	LARGH. (cm) WIDTH (cm)	PTS.
	FONDO PENSILE CON "PRESA A GOCCIA" Da aggiungere al costo del pensile scelto	CHAMPAGNE 15 + 12	
	WALL UNIT BOTTOM WITH INDENT To add to the cost of the wall unit chosen	CHAMPAGNE 30 + 12	
		CHAMPAGNE 40 + 12	
		CHAMPAGNE 45 + 12	
		CHAMPAGNE 60 + 16	
		CHAMPAGNE 65 + 16	
		CHAMPAGNE 75 + 16	
		CHAMPAGNE 80 + 16	
		CHAMPAGNE 90 + 16	
		CHAMPAGNE 120 + 16	
		NERO SPAZZOLATO 15 + 12	
		NERO SPAZZOLATO 30 + 12	
		NERO SPAZZOLATO 40 + 12	
		NERO SPAZZOLATO 45 + 12	
		NERO SPAZZOLATO 60 + 16	
		NERO SPAZZOLATO 65 + 16	
		NERO SPAZZOLATO 75 + 16	
		NERO SPAZZOLATO 80 + 16	
		NERO SPAZZOLATO 90 + 16	
		NERO SPAZZOLATO 120 + 16	

MAGGIORAZIONI PER SISTEMI DI APERTURA

SURCHARGES FOR OPENING SYSTEMS

ARTICOLO ARTICLE	MAGGIORAZIONE SURCHARGE	H. (cm) H. (cm)	L. (cm) W. (cm)	PTS.
	FERRAMENTA ESTRAIBILE GALAXY LUX, per elemento finitura TITANIO e STONE			
	GALAXY LUX HARDWARE EXTRACTABLE, for element finish TITANIO and STONE			
	Base Estraiabile Pull-Out Base Unit	78/81	15	+ 44
	Pensile Estraiabile Pull-Out Wall Unit	72	15	+ 38
		96	15	+ 38
	Colonna Estraiabile Pull-Out Tall Unit	210-234	15	+ 70
	Colonna Estraiabile Girevole Pull-Out Revolving Tall Unit	210-234	30	+ 98
	Colonna Attrezzata Total View Pull-Out Revolving Tall Unit	210-234	45	+ 136
		210-234	60	+ 176



TITANIO STONE

MAGGIORAZIONI GRIGLIA AERAZIONE

SURCHARGES FOR AERATION GRID SURCHARGE

MAGGIORAZIONE SURCHARGE	PTS.
GRIGLIA ZOCCOLO PER AERAZIONE ELETTRODOMESTICI IN COLONNA FRIGO, FORNO E FORNO CON MICROONDE La griglia di aerazione crea un effetto camino che raffredda l'elettrodomestico facendo passare l'area nel vuoto sanitario nel retro colonna.	Cad. 1 Each + 10
GRID PLINTH FOR VENTILATION APPLIANCES IN TALL UNIT FRIDGE, OVEN AND MICROWAVE OVEN The ventilation grille creates a chimney effect that cools the appliance by passing the area into the sanitary space in the back tall unit.	

SISTEMI DI APERTURA chiusure elettriche, limitatori aperture, braccetti e accessori

OPENING SYSTEMS electric locks, openings limiters, arms and accessories

ARTICOLO ARTICLE	MAGGIORAZIONE SURCHARGE	LARGH. (cm) WIDTH (cm)	PTS.
	<p>APERTURA ELETTRICA per Pensili con apertura Vasistas, Basculante, Vela e Soffietto</p> <p>ELECTRIC OPENING for wall unit with Lift-up, Up&Over, Pull + Slide and Folding opening</p>	Cad. 1 Each	+ 506



	<p>PENDOLO PER FACILITARE CHIUSURA VASISTAS Per quello superiore nel caso di due pensili vasistas sovrapposti</p> <p>PENDULUM TO AID LIFT-UP OPENING For the upper in the case of two overlaid lift-up wall units</p>	Cad. 1 Each	F000300	7
--	--	----------------	---------	----------

	<p>MECCANISMO DI SOSTEGNO ANTE DOOR SUPPORT MECHANISM</p>	Cad. 1 Each	F00201	2
--	--	----------------	--------	----------

	<p>CERNIERA RALLENTATA E COPRICERNIERA PER ELEMENTI CON ANTA</p> <p>- finitura ACCIAIO di serie in tutti gli elementi con anta - a richiesta con maggiorazione + 3 PTS. cad. 1 in tutti gli elementi con anta</p> <p>SOFT-CLOSING HINGES AND HINGE COVER FOR ELEMENTS WITH DOORS</p> <p>- STEEL finish <u>standard</u> for all the elements with doors - PEWTER finish on request with surcharge + 3 PTS. each. 1 for all the elements with doors</p>			
--	--	--	--	--

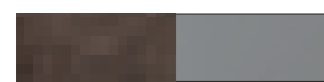

PELTRO ACCIAIO



Occorre n° 1 trasformatore per alimentare da 1 a 3 meccanismi di apertura

1 transformer is required to power from 1 to 3 opening mechanisms

ACCESSORI INTERNI, ripiani interni

INTERNAL ACCESSORIES, inner shelves

ARTICOLO ARTICLE	DESCRIZIONE DESCRIPTION	LARGH. (cm) WIDTH (cm)	CODICE CODE	PTS.	
	<p>RIPIANO VETRO INTERNO Compresi di reggiripiani INTERNAL GLASS SHELF Including shelf brackets</p>	<p>Base e Colonna da 30 Base unit and Tall unit from 30</p> <p>Base e Colonna da 45 Base unit and Tall unit from 45</p> <p>Base e Colonna da 60 Base unit and Tall unit from 60</p> <p>Base e Colonna da 75 Base unit and Tall unit from 75</p> <p>Pensile da 30 Wall unit from 30</p> <p>Pensile da 45 Wall unit from 45</p> <p>Pensile da 60 Wall unit from 60</p> <p>Pensile da 75 Wall unit from 75</p> <p>Pensile da 90 Wall unit from 90</p>	<p>25,5 x 51,8</p> <p>40,5 x 51,8</p> <p>55,5 x 51,8</p> <p>70,5 x 51,8</p> <p>25,5 x 30,6</p> <p>40,5 x 30,6</p> <p>55,5 x 30,6</p> <p>70,5 x 30,6</p> <p>88,5 x 30,6</p>	<p>61RB030.01</p> <p>61RB045.03</p> <p>61RB060.03</p> <p>61RB075.03</p> <p>61RP030.01</p> <p>61RP045.01</p> <p>61RP060.02</p> <p>61RP075.02</p> <p>61RP090.02</p>	<p>10</p> <p>13</p> <p>15</p> <p>24</p> <p>9</p> <p>10</p> <p>11</p> <p>16</p> <p>15</p>
	<p>REGGIRIPIANO PER RIPIANO, n° 1 Con Bloccaggio SHELF BRACKET FOR SHELF, 1 pcs With locking device</p>	PELTRO	5	5FMR020215	1,5
	<p>RIPIANO MOBILE STRIKE ALLUMINIO + VETRO, sp. 2,8 cm Per basi e colonne STRIKE INTERNAL ALUMINUM + GLASS SHELF, th. 2,8 cm For basi units and tall units</p>	TITANIO	45 60 75	61RB045.05 61RB060.05 61RB075.05	60 68 72
	<p>RIPIANO MOBILE STRIKE ALLUMINIO + VETRO, sp. 2,8 cm Per pensili STRIKE INTERNAL ALUMINUM + GLASS SHELF, th. 2,8 cm For wall units</p>	TITANIO	45 60 75 90	61RP045.05 61RP060.05 61RP075.05 61RP090.05	53 56 60 70
	<p>RIPIANO MOBILE STRIKE ALLUMINIO + VETRO, sp. 2,8 cm Per pensili STRIKE INTERNAL ALUMINUM + GLASS SHELF, th. 2,8 cm For wall units</p>	NERO SPAZZOLATO	45 60 75 90	61RB045.05 61RB060.05 61RB075.05 61RB090.05	63 72 99
	<p>RIPIANO MOBILE STRIKE ALLUMINIO + VETRO, sp. 2,8 cm Per pensili STRIKE INTERNAL ALUMINUM + GLASS SHELF, th. 2,8 cm For wall units</p>	NERO SPAZZOLATO	45 60 75 90	61RP045.05 61RP060.05 61RP075.05 61RP090.05	56 60 76 72
	<p>PROFILO DI FINITURA FRONTALE IN ACCIAIO PER RIPIANI INTERNI STAINLESS STEEL FRONTAL PROFILE FOR INTERNAL SHELVES</p>	ALLUMINIO	30 45 60 75 90 105 120	5FMR030101 5FMR030102 5FMR030103 5FMR030107 5FMR030104 5FMR030106 5FMR030105	6 6 6 11 8 8 8
	<p>PROFILO DI FINITURA FRONTALE IN ACCIAIO PER RIPIANI INTERNI STAINLESS STEEL FRONTAL PROFILE FOR INTERNAL SHELVES</p>	NERO SPAZZOLATO	30 45 60 75 90 105 120	5FMR030201 5FMR030202 5FMR030203 5FMR030207 5FMR030204 5FMR030206 5FMR030205	7 7 7 14 12 12 12

ACCESSORI INTERNI, ricambi per colapiatti

INTERNAL ACCESSORIES, spares for dish drainers

COLAPIATTI DELUXE
DELUXEDISH DRAINER UNITS

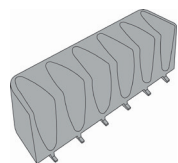

KIT PORTAPIATTI
KIT PLATE-RACK



GRIGLIA PORTAPIATTI
PLATE-RACK

GRIGLIA PORABICCHIERE
GLASS-RACK

VASCHETTA PVC RACCOGLIGOCCE
PVC DRIP TRAY

KIT PORTAPOSATE
KIT CUTLERY-TRAY

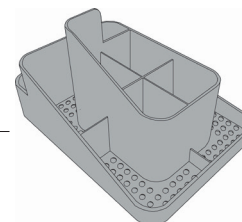

ARTICOLO ARTICLE	DESCRIZIONE DESCRIPTION	H. (cm) H. (cm)	LARGH. (cm) WIDTH (cm)	PTS.
	MAGGIORAZIONE KIT INTERNO PER COLAPIATTI PR. 34 cm SURCHARGE INTERNAL KIT FOR DISH DRAINER D. 34 CM	36	60	+ 10
	1 griglia portabicchieri + 1 kit portapiatti + vaschetta PVC raccogli gocce 1 glass-rack + 1 kit plate-rack + PVC drip tray	36 NEW	75	+ 17
		36	90	+ 10
		36	120	+ 10
		48	60	+ 10
		48	75	+ 17
		48	90	+ 10
		48	120	+ 10
1 griglia portapiatti 1 griglia portabicchieri + vaschetta PVC raccogli gocce 1 glass-rack + 1 plate-rack + PVC drip tray	60	45	+ 45	
	60	60	+ 45	
	60 NEW	75	+ 45	
	60	90	+ 45	
	60	120	+ 45	
	72	45	+ 45	
	72	60	+ 45	
	72 NEW	75	+ 45	
	72	80	+ 45	
	72	90	+ 45	
	72	120	+ 45	
	96	45	+ 45	
	96	60	+ 45	
	96 NEW	75	+ 45	
96	80	+ 45		
96	90	+ 45		
108	45	+ 45		
108	60	+ 45		
MAGGIORAZIONE: vaschetta inox raccogli gocce (vaschetta inox raccogli gocce inclusa nel colapiatti da 120) SURCHARGE: steel drip tray (steel tray included in the dish drainer 120)	-	45 - 60 - 75	+ 20	
	-	80 - 90	+ 26	
KIT PORTAPIATTI KIT PLATE-RACK	-	200IE00A00	18	
	-	200IE00A01	18	
KIT PORTAPOSATE KIT CUTLERY-TRAY	-	-	-	

Informazioni utili

Useful informations

RILEVAMENTO ANGOLI FUORI SQUADRA / MEASURING OUT OF SQUARE CORNERS

INFORMAZIONI PER LA PROGETTAZIONE / DESIGN INFORMATION

INFORMAZIONI GENERALI / GENERAL INFORMATION

Rilevamento angoli fuori squadra

Measuring out of square corners

ELEMENTI DA SOMMARE ELEMENTS TO BE ADDED

ANGOLO RETTO

Nel caso in cui la misura della diagonale rilevata ad 1 metro dall'angolo sia di 141,4 cm l'angolo risulterà di 90°.

RIGHT ANGLE

If the diagonal line joining the two walls measured 1 metre away from the corner is 141.4 cm, the angle is 90°.

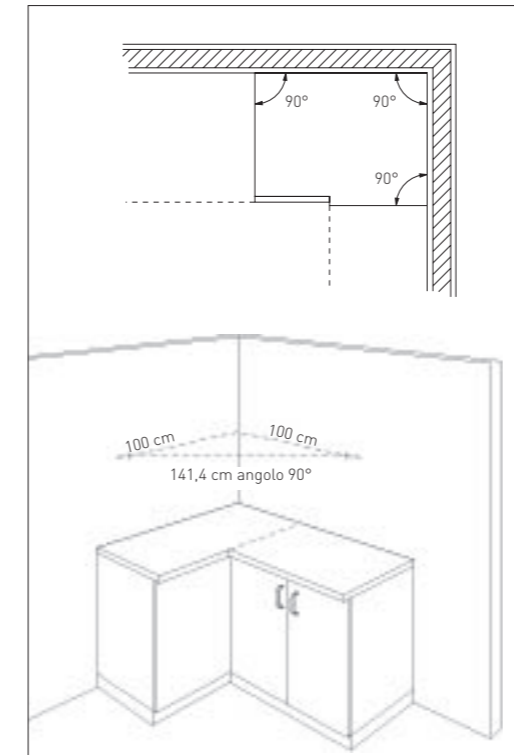

ELEMENTI DA SOMMARE ELEMENTS TO BE ADDED

ANGOLO ACUTO

Nel caso in cui la misura della diagonale rilevata ad 1 metro dall'angolo sia inferiore a 141,4 cm l'angolo risulterà $\leftarrow 90^\circ$.

RIGHT ANGLE

If the diagonal line joining the two walls measured 1 metre away from the corner is shorter than 141.4 cm, the angle is $\leftarrow 90^\circ$.

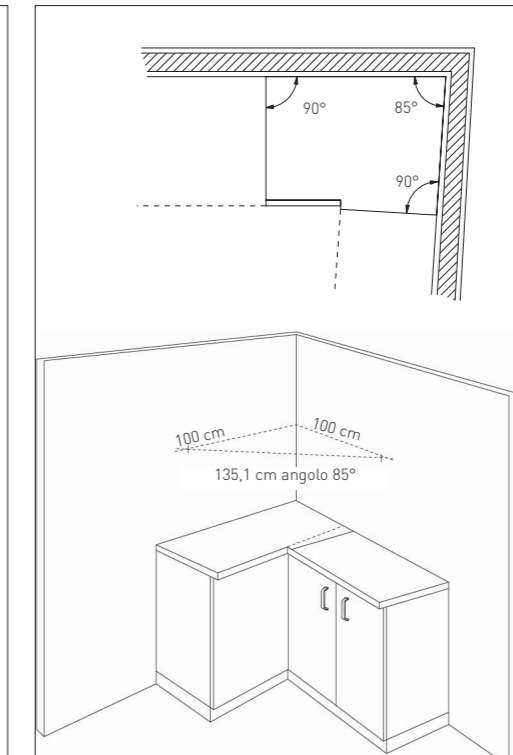

ELEMENTI DA SOMMARE ELEMENTS TO BE ADDED

ANGOLO OTTUSO

Nel caso in cui la misura della diagonale rilevata ad 1 metro dall'angolo sia maggiore di 141,4 cm l'angolo risulterà $\rightarrow 90^\circ$.

RIGHT ANGLE

If the diagonal line joining the two walls measured 1 metre away from the corner is greater than 141.4 cm, the angle is $\rightarrow 90^\circ$.

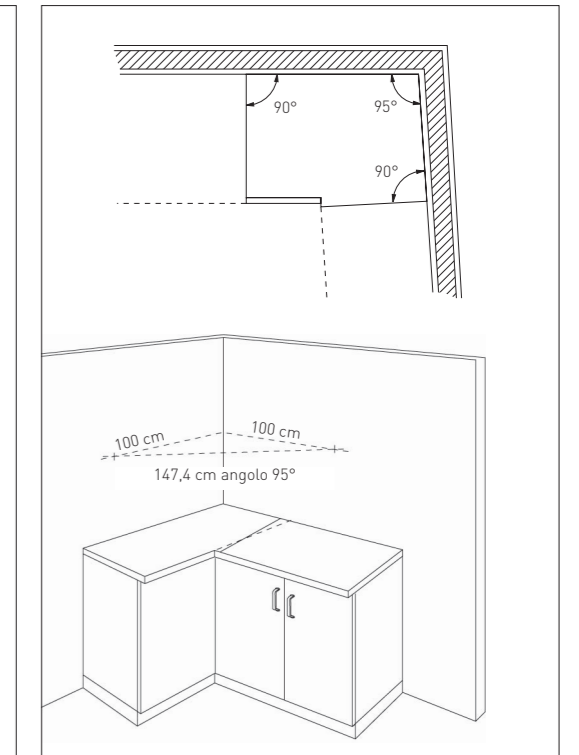

VARIAZIONE DIMENSIONE MOBILE

Per ogni grado che va a cambiare l'angolo fuori squadra (in aumento o in diminuzione dell'angolo di 90° di riferimento) corrisponde 1 cm circa di variazione sul mobile fuori misura da realizzare. Nel caso di angolo maggiore di 90° la dimensione del pensile e della base si riduce; nel caso di angolo minore di 90° la dimensione del pensile e della base aumenta.

VARIATION OF THE CABINET DIMENSIONS

Every one degree modifying the out of square corner (an increase or decrease of the 90° reference angle) corresponds to roughly a 1 cm variation in the out of square cabinet to be constructed. If the angle is greater than 90°, the dimensions of the wall unit or base unit decrease; if the angle is smaller than 90°, the dimensions of the wall unit or base unit increase.

Qui a fianco sono riportate due tabelle, una per gli angoli ottusi una per gli acuti con le varie casistiche di fuori squadra.

The adjacent tables list the acute angles and obtuse angles respectively, alongside the various out of square cases.

ANGOLO ACUTO ACUTE ANGLE

DIAGONALE DIAGONAL	ANGOLO ANGLE
141,4	90°
140,8	89,5°
140,2	89°
139,5	88,5°
138,9	88°
138,3	87,5°
137,7	87°
137,0	86,5°
136,2	86°
135,8	85,5°
135,1	85°
134,5	84,5°
133,8	84°
133,2	83,5°
132,5	83°
131,9	82,5°
131,2	82°
130,6	81,5°
129,9	81°
128,2	80,5°
128,6	80°

ANGOLO OTTUSO OBTUSE ANGLE

DIAGONALE DIAGONAL	ANGOLO ANGLE
141,4	90°
142,0	90,5°
142,6	91°
143,2	91,5°
143,9	92°
144,5	92,5°
145,1	93°
145,7	93,5°
146,3	94°
146,9	94,5°
147,4	95°
148,0	95,5°
148,8	96°
149,2	96,5°
149,8	97°
150,4	97,5°
150,9	98°
151,5	98,5°
152,1	99°
152,6	99,5°
153,2	100°

Informazioni per la progettazione

Design information

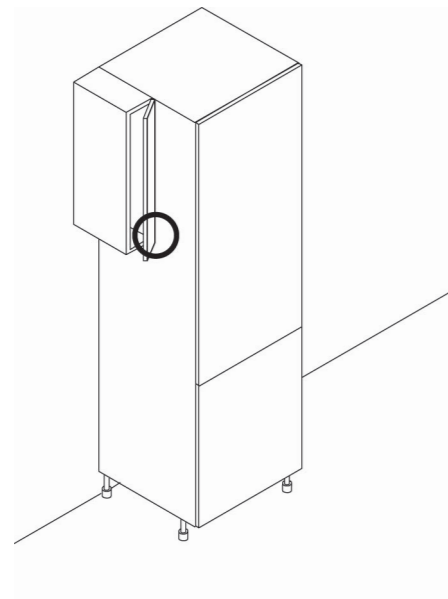

PENSILE DA 15 E 30 CON ACCANTO UNA COLONNA SUL LATO CERNIERE

15 AND 30 CM WALL UNIT WITH ADJACENT TALL UNIT ON THE HINGE SIDE

Attenzione l'anta si apre parzialmente in quanto sbatte la maniglia impedendo l'accesso all'interno del vano. In questa situazione consigliamo l'inserimento del pensile di larghezza variabile (da 15 a 30 cm) con apertura estraibile o di cambiare il verso di apertura dell'anta (in questo caso da Dx a Sx).

Attention: the door opens partially as it clashes with the handle, thus preventing access to the inside of the compartment. In this situation, we recommend inserting a variable width (from 15 to 30 cm) wall unit with pull-out opening, or modifying the door opening direction (in this case from RH to LH).

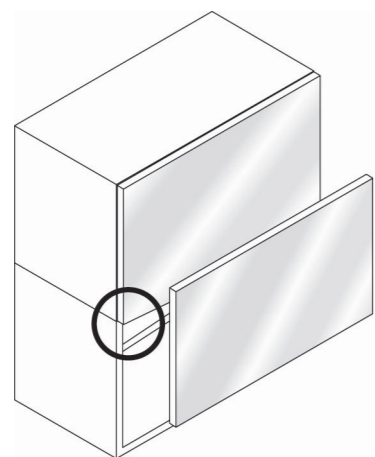

PENSILE APERTURA VERTICALE A VELA POSIZIONATO SOTTO ALTRO PENSILE O ELEMENTO CON PROFONDITÀ SUPERIORE A 34 CM

WALL UNIT WITH VERTICAL DOOR OPENING SYSTEM POSITIONED BENEATH ANOTHER WALL UNIT OR ELEMENT WITH DEPTH EXCEEDING 34 CM

Attenzione l'anta non si apre in quanto il suo meccanismo sbatte contro l'anta del pensile superiore. Evitare l'inserimento di tale struttura, eventualmente scegliere altro pensile con stessa altezza ma con diversa apertura (es. Vasisas).

Attention: the door does not open as its mechanism clashes with the door of the wall unit above. Avoid inserting such an element, alternatively, select another wall unit with the same height but different opening system (e.g. lift-up door).

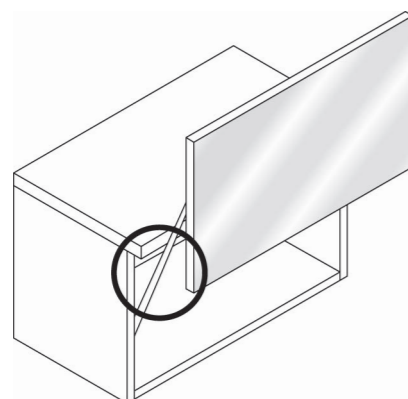

POSIZIONAMENTO PENSILI DA EVITARE SOTTO MENSOLE O ELEMENTI CON PROFONDITÀ SUPERIORE A 34 CM

WALL UNITS NOT TO BE POSITIONED UNDER SHELVES OR ELEMENTS WITH DEPTH EXCEEDING 34 CM

Attenzione le ante delle seguenti strutture non si aprono

- Pensile apertura verticale a Vela
- Pensile apertura Basculante

Attention: the doors of the following units do not open:

- Wall unit with vertical door opening system
- Wall unit with up & over door

Informazioni per la progettazione

Design information

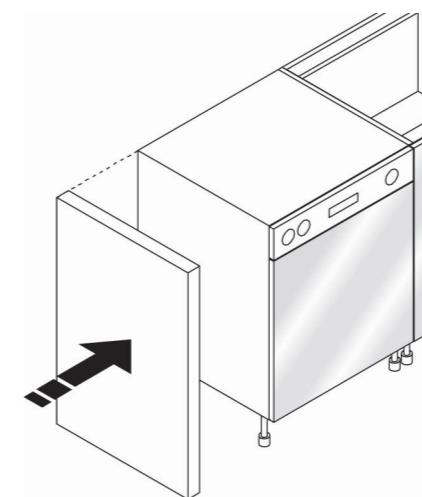

APPLICAZIONE DI FIANCHI DISTANZIALI PER LAVASTOVIGLIE O LAVATRICE

APPLICATION OF SPACERS FOR DISHWASHERS OR WASHING MACHINES

Queste strutture non hanno un fianco a finire, pertanto considerare, se sono a vista, l'applicazione di un fianco.

These elements do not have a finished side, therefore - if they are exposed - consider applying a side panel.

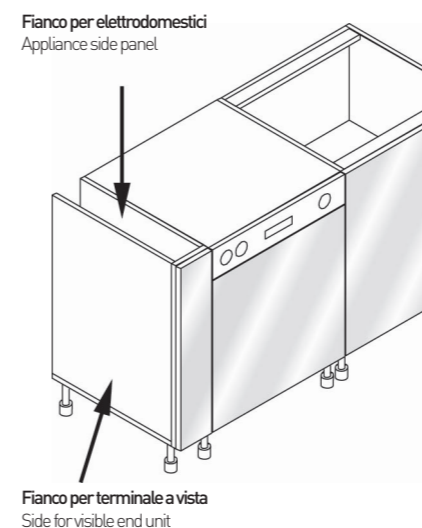

APPLICAZIONE DI UN FIANCO NOBILITATO SULLA FASCIA DI TAMPONAMENTO

APPLICATION OF A MELAMINE SIDE PANEL ON THE FILLER

La fascia di tamponamento non ha un fianco finito. Qualora la struttura in oggetto si trovi adiacente ad elementi che non necessitano di struttura completa di fianchi (es. lavastoviglie, lavatrici, frigoriferi, congelatori...), si consiglia di applicare un fianco in nobilitato sp. 1,8 cm all'interno della stessa fascia di tamponamento. Quando la fascia di tamponamento viene inserita come ultimo elemento a vista di una composizione, oltre che applicare un fianco come già indicato precedentemente, si consiglia di applicare in aggiunta un coprifianco.

The filler does not have a finished side. If the relevant carcass lies adjacent to elements that do not require a carcass inclusive of sides (e.g. dishwashers, washing machines, fridges, freezers, etc.), we recommend applying a 1.8 thick melamine side panel inside the filler. When the filler is inserted as the final visible element of a composition, besides the application of a side panel as previously specified, it is advisable to also add a cover side.

Informazioni per la progettazione

Design information

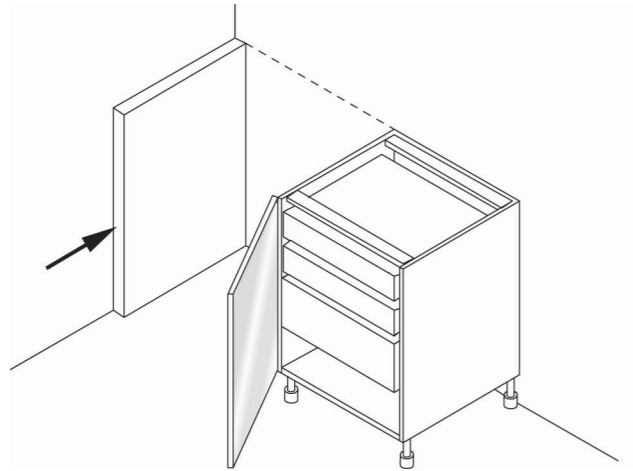

STRUTTURA CON CASSETTI O CESTI INTERNI A RIDOSSO DEL MURO CARCASS WITH INNER DRAWERS OR DEEP-PAN DRAWERS DRAWN AGAINST THE WALL

Attenzione! I cassetti o cesti non si estraggono. Qualora una colonna frigorifero o una struttura con elementi estraibili venga posizionata a ridosso del muro occorre l'uso di un elemento distanziale di minimo 3 cm.

Attention! The drawers or deep-pan drawers cannot be pulled out. If a fridge tall unit or carcass with pull-out elements is positioned against the wall, a spacer measuring at least 3 cm must be inserted.

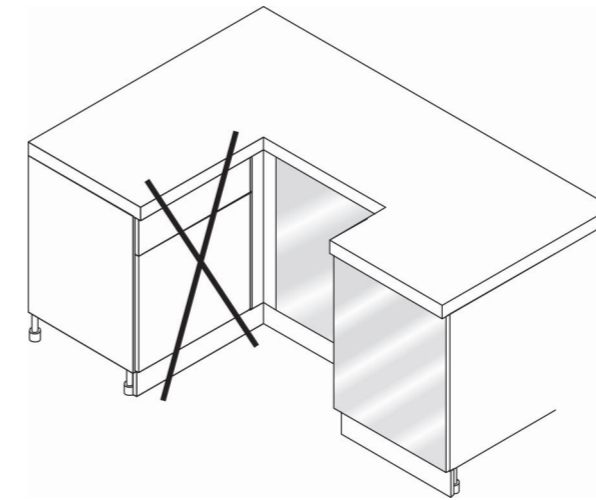

DISTANZA MINIMA DA MANTENERE PER CORPI AVANZATI MINIMUM DISTANCE TO BE OBSERVED FOR PROJECTING ELEMENTS

Attenzione! Non inserire mai basi con tavolo estraibile a ridosso di corpi avanzati.

Attention! Do not insert base units with pull-out table next to projecting elements.

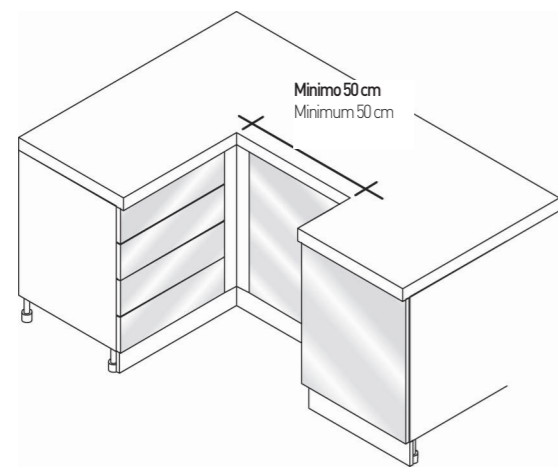

DISTANZA MINIMA DA MANTENERE PER CORPI AVANZATI MINIMUM DISTANCE TO BE OBSERVED FOR PROJECTING ELEMENTS

Attenzione! Nel caso di basi con elementi estraibili / basi per inserimento forno, a ridosso di corpi avanzati, considerare uno spazio minimo da mantenere di cm 50, per permettere la perfetta apertura delle ante.

Attention! If base units with pull-out elements / oven base units are drawn against projecting elements, consider minimum 50 cm to ensure proper opening of the doors.

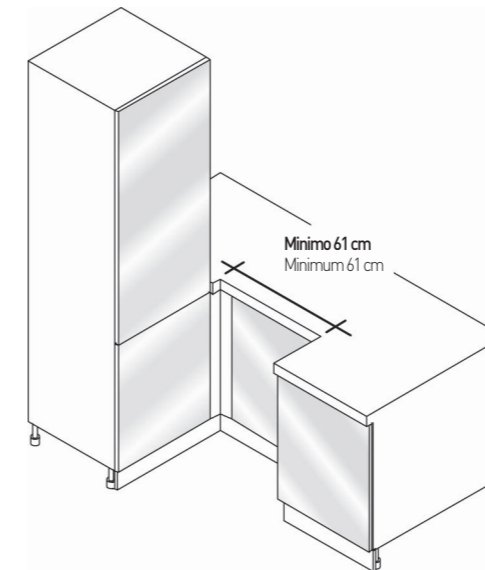

MINIMUM DISTANCE TO BE OBSERVED FOR PROJECTING ELEMENTS

Attenzione! Nel caso di frigoriferi e basi con lavastoviglie comandi a vista a ridosso di corpi avanzati, considerare uno spazio minimo da mantenere di cm 61, per permettere la perfetta apertura delle ante.

Attention! If fridges and base units with dishwasher w/visible controls are drawn against projecting elements, consider minimum 61 cm to ensure proper opening of the doors.

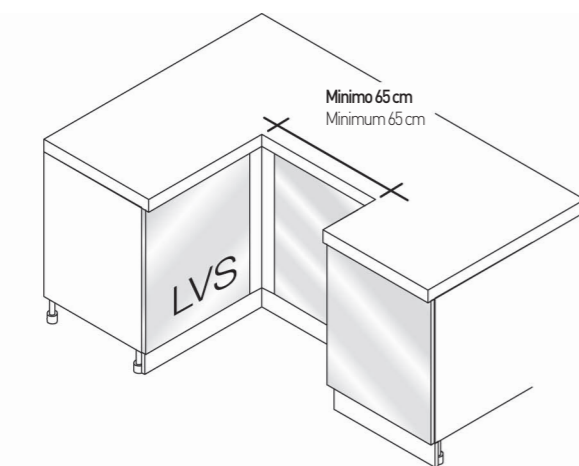

DISTANZA MINIMA DA MANTENERE PER CORPI AVANZATI MINIMUM DISTANCE TO BE OBSERVED FOR PROJECTING ELEMENTS

Attenzione! Nel caso di basi con lavastoviglie a scomparsa totale a ridosso di corpi avanzati, considerare uno spazio minimo da mantenere di cm 65, per permettere la perfetta apertura delle ante.

Attention! If base units with fully integrated dishwasher are drawn against projecting elements, consider minimum 65 cm to ensure proper opening of the doors.

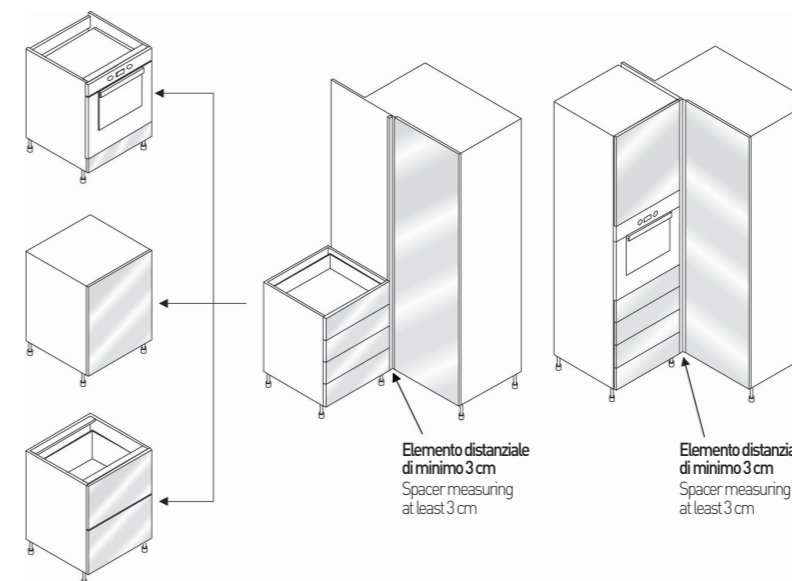

INSERIMENTO OBBLIGATORIO DI FASCIA TAMPONAMENTO DA 3 CM MANDATORY INSERTION OF A 3 CM FILLER

Attenzione! Inserire sempre tra colonne angolo e basi con elementi estraibili (es. cassettiere, cesti estraibili) e basi per inserimento elettrodomestici, un elemento distanziale di minimo 3 cm.

Attention! Always insert a spacer of at least 3 cm between corner tall units and base units with pull-out elements (e.g. base units with 4 drawers, pull-out deep-pan drawers), and appliance base units.

Informazioni per la progettazione

Design information

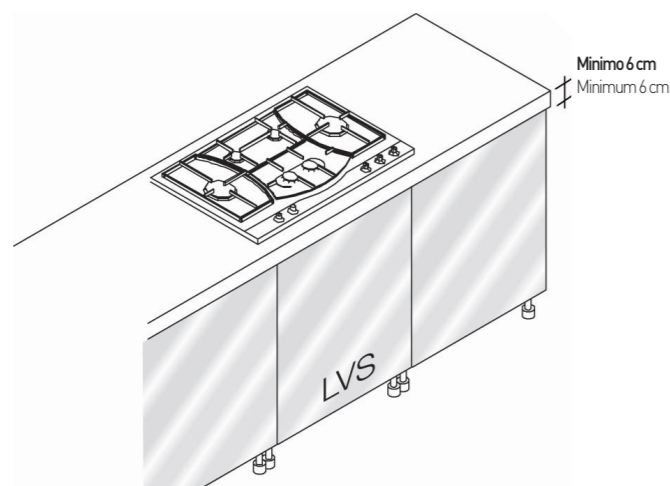

INSERIMENTO OBBLIGATORIO DI TOP SP. CM 6 SOPRA BASI PER ELETTRODOMESTICI MANDATORY INSERTION OF A WORKTOP TH. 6 CM ABOVE APPLIANCE BASE UNITS

Attenzione! Nel caso si voglia inserire un piano cottura sopra basi per lavastoviglie, lavatrice e frigo, considerare obbligatoriamente il piano di appoggio di spessore minimo 6 cm.

Attention! When inserting a cooker hob above dishwasher, washing machine and fridge units, always consider a worktop of at least 6 cm thickness.

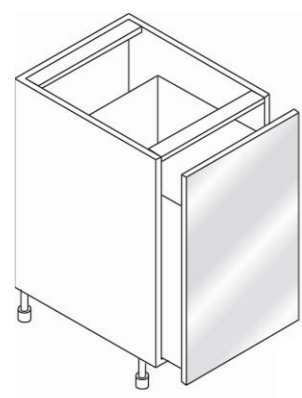

STRUTTURE NON RIDUCIBILI IN PROFONDITÀ (CESTI) CARCASSES THAT CANNOT BE REDUCED DEPTH-WISE (DEEP-PAN DRAWERS)

Attenzione! Tutte le strutture con elementi estraibili non sono riducibili in profondità.

Attention! All carcasses with pull-out elements cannot be reduced depth-wise.

Informazioni per la progettazione

Design information

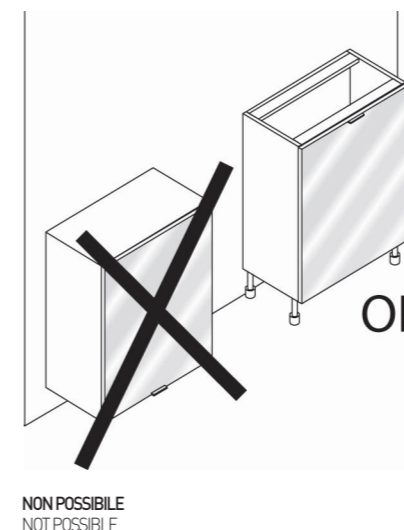

STRUTTURE CHE NON È POSSIBILE INSERIRE CARCASSES THAT CANNOT BE INSERTED

Attenzione! Non è possibile inserire un pensile uso base. Si deve obbligatoriamente prendere una Base ad un'anta di serie e ridurre in profondità.

Attention! It is not possible to insert a wall unit used as a base unit. It is mandatory to use a base unit with one standard door and reduce the depth.

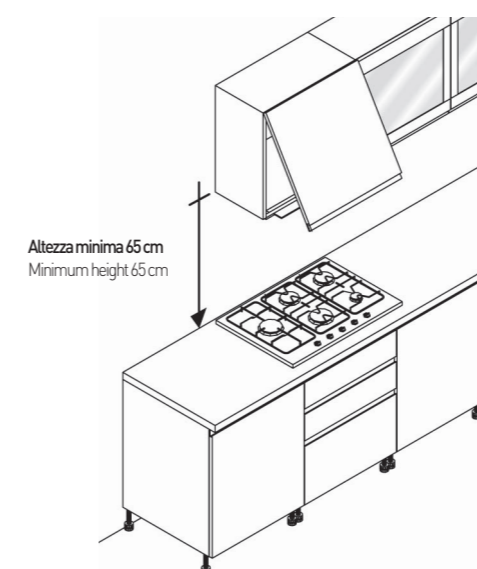

ALTEZZA MINIMA FRA ZONA COTTURA E CAPPA MINIMUM HEIGHT BETWEEN COOKER HOB AND HOOD

Attenzione! Per ragioni di sicurezza mantenere sempre un'altezza minima di 65 cm fra top con piano cottura e sotto cappa.

Attention! For safety reasons, always leave at least 65 cm between the worktop with cooker hob and the bottom of the hood.

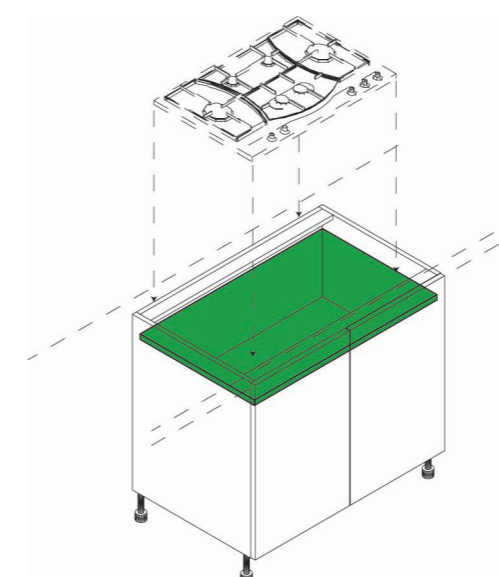

INSERIMENTO DEL "SETTO SEPARATORE" INCLUSION OF "SEPARATING BAFFLE"

Molte case costruttrici dei piani cottura richiedono l'inserimento di un "setto separatore", sotto il piano cottura, al fine di isolare il calore dalle parti accessibili esterne. STOSA al momento dell'ordine inserirà un "setto separatore" di serie valido per tutti i piani cottura in vendita. L'elemento di serie inserito, potrebbe ridurre il volume utilizzabile del vano sottostante rispetto ad altre soluzioni applicabili dal personale abilitato addetto al montaggio e concordate tra il rivenditore e il privato. Pertanto si richiede, qualora il rivenditore e il personale abilitato addetto al montaggio, non abbiano individuato alternative tecniche più congeniali all'utilizzo del mobile, di specificare sempre la presenza del "setto separatore" al momento dell'ordine.

Si fa rilevare che il "setto separatore" di serie potrebbe non essere inseribile se richiesto successivamente all'ordine.

Many manufacturers of hobs require the insertion of a "separator plate", under the hob, in order to isolate heat from the external accessible parts.

STOSA when the order may provide a "separator plate" valid serial for all hobs for sale. The inserted element series, could reduce the usable volume of the compartment below compared to other solutions applicable by the authorized personnel to mount and agreed between the dealer and the private. Therefore, it requires, if the dealer and the enabled personnel, to the assembly, have not identified any more congenial technical alternatives to the use of the cabinet, always specify the presence of the "separator plate" when ordering.

It should be noted that the "separator plate" series may not be inserted if required after order.

Informazioni per la progettazione

Design information

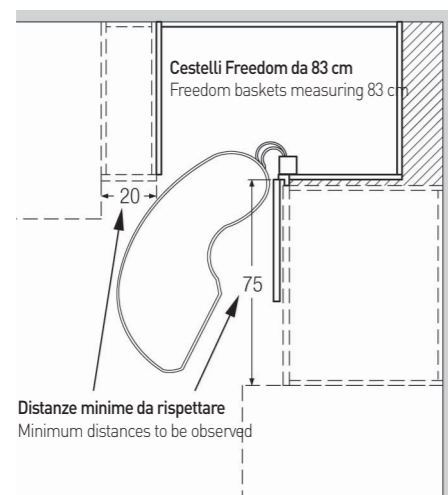

Distanze minime da rispettare
Minimum distances to be observed

DISTANZA MINIMA DA MANTENERE PER BASI E COLONNE ANGOLO CON CESTELLI FREEDOM DA 83 CM

MINIMUM DISTANCE TO CONSIDER FOR CORNER BASE UNITS AND TALL UNITS WITH FREEDOM BASKETS MEASURING 83 CM

Attenzione! Nel caso di basi o colonne con cestelli Freedom da 83 cm, a ridosso di corpi avanzati, mantenere uno spazio minimo di 75 cm da un lato e 20 cm dall'altro, per permettere l'estrazione totale dei cestelli.

Attention! For base units or tall units with Freedom baskets measuring 83 cm, adjacent to projecting elements, leave at least 75 cm on one side and 20 cm on the other side, so that the baskets can be fully extracted.

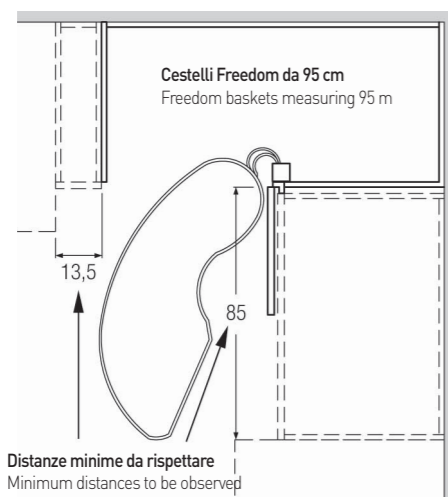

Distanze minime da rispettare
Minimum distances to be observed

DISTANZA MINIMA DA MANTENERE PER BASI E COLONNE ANGOLO CON CESTELLI FREEDOM DA 95 CM

MINIMUM DISTANCE TO CONSIDER FOR CORNER BASE UNITS AND TALL UNITS WITH FREEDOM BASKETS MEASURING 95 CM

Attenzione! Nel caso di basi o colonne con cestelli FREEDOM da 95 cm, a ridosso di corpi avanzati, mantenere uno spazio minimo di 85 cm da un lato e 13,5 cm dall'altro, per permettere l'estrazione totale dei cestelli.

Attention! For base units or tall units with Freedom baskets measuring 95 cm, adjacent to projecting elements, leave at least 85 cm on one side and 13.5 cm on the other side, so that the baskets can be fully extracted.

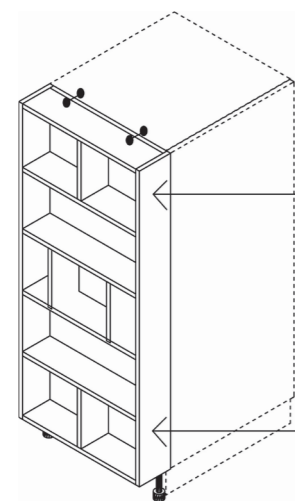

Fissaggio effettuato all'interno del fianco colonna adiacente
Fixing effected from inside the adjacent tall unit side panel

Fissaggio effettuato all'interno del fianco colonna adiacente
Fixing effected from inside the adjacent tall unit side panel

ELEMENTO TERMINALE A GIORNO H. 132 - 204 PROF. 15 A RIDOSSO DI UNA COLONNA OPEN END ELEMENT H. 132 - 204 DEPTH 15 ADJACENT TO TALL UNIT

Attenzione! L'elemento terminale non può essere mai messo come elemento a sé stante appoggiato ad una colonna, poiché non è strutturale ma solamente un elemento estetico di finitura. Deve essere sempre accostato e fissato con delle viti dall'interno del fianco colonna adiacente.

Attention! The end element must never be inserted as a supporting element adjacent to a tall unit, as it does not have a structural function but is a mere aesthetic finishing element. It must always be drawn up against the tall unit and secured with screws from inside the latter's side panel.

Informazioni generali

General informations

PRODOTTO PRODUCT

I dati tecnici relativi ai prodotti illustrati nel presente listino sono indicativi.

La Stosa S.p.A. si riserva la facoltà di apportare tutte le modifiche tecnico - costruttive migliorative del prodotto, senza obbligo di preavviso. Ciò vale anche per gli elettrodomestici installati nelle forniture: essi potranno risultare nelle forme e nell'aspetto diversi dal campione raffigurato pur nel rispetto sostanziale delle caratteristiche di qualità e funzionalità.

The technical data relating to the products illustrated in the present price list are indicative.

Stosa S.p.A. reserve the right to make any technical changes - constructional improvements to the product without prior notice. This also applies to the appliances installed in the products supplied: these may be in a form and appearance different from the sample shown while respecting the fundamental qualitative and functional characteristics.

TERMINI DI CONSEGNA TERMS OF DELIVERY

La merce sarà approntata per la spedizione entro il termine indicativo di 3/8 settimane dal ricevimento dell'ordine, salvo imprevisti. Eventuali ritardi non potranno dare luogo a responsabilità o diritti di indennità di qualsiasi genere, né tantomeno all'annullamento dell'ordine, salvo diverso accordo tra le parti.

Non si accettano variazioni degli ordini o annullamenti decorati due giorni dalla conferma ordine inviata da parte di Stosa s.p.a.. Sarà richiesta la conferma dell'ordine in caso di ordini di materiali speciali che la richiedono. In assenza di conferma scritta l'ordine rimarrà bloccato.

The goods will be prepared for shipping within the approximate period of 3/8 weeks from receipt of the order, barring unforeseen circumstances. Possible delays can not give rise to liability or rights to claims of any kind, nor to cancel the order, unless otherwise agreed between the parties.

Changes to or cancellations of orders after two days from the confirmation of the order sent by Stosa s.p.a. are not accepted. Confirmation of the order will be requested in the case of orders that require special materials. In the absence of written confirmation the order will remain blocked.

INSTALLAZIONE INSTALLATION

La Stosa S.p.A. declina ogni responsabilità per negligenza errata o cattiva installazione del prodotto fornito, sia esso di sua fabbricazione che di terzi - intendendosi quale prodotto - i mobili da cucina - i singoli elementi e tutti gli accessori ed elettrodomestici che la compongono nessuno escluso e/o eccettuato.

Nello specifico sia l'installatore che il cliente nella fase di installazione si devono attenere scrupolosamente alle indicazioni contenute nel libretto d'installazione dei mobili da cucina - dei singoli elementi e degli elettrodomestici - il mancato scrupoloso rispetto delle istruzioni e delle modalità di composizione installazione e montaggio degli elementi escludono la garanzia del prodotto.

Ulteriori ed eventuali elementi ritenuti necessari per l'installazione sia dei mobili da cucina dei singoli elementi e degli elettrodomestici - potranno anche far parte del listino degli accessori prodotti e forniti da Stosa S.p.a. Disponibili nella parte accessori - elementi che potranno eventualmente essere acquistati anche separatamente e distintamente dalla cucina. Eventuali contestazioni o danni derivanti da erronea installazione della cucina dei mobili da cucina - degli accessori e degli apparecchi e degli elettrodomestici ivi presenti o la mancanza di elementi previsti come necessari e/o utili dalla STOSA S.P.A. dallo stesso produttore dei mobili da cucina o dal costruttore degli elettrodomestici - costituirà fonte di responsabilità diretta dell'installazione e del cliente con contestuale esclusione di responsabilità a carico di STOSA S.P.A. - in deroga espressa alla responsabilità per la tutela del consumatore - non procedendo appunto la STOSA S.p.a. alla relativa installazione delle cucine - di cui la non conforme installazione costituisce clausola espressa di esclusione di responsabilità per la STOSA S.p.a.

Stosa S.p.A. accepts no responsibility for negligence, wrong, incorrect or poor installation of the product supplied, whether manufactured by themselves or by third parties - understood as product - kitchen furniture - individual elements and all accessories and household appliances that comprise it, none excluded and/or excepted. Specifically, both the installer and the customer must strictly adhere to the instructions contained in the installation manual of the kitchen units - the individual elements and the appliances - during the installation. The lack of adherence to the instructions and the build, installation and assembly methods of the elements, exclude the product warranty. Any additional elements deemed necessary for the installation of both the kitchen units, the individual elements and the appliances - may also be included in the price list of accessories manufactured and supplied by Stosa S.p.a. Available in the accessories section - items that could possibly be purchased separately and distinctly from the kitchen. Possible complaints or damage resulting from the incorrect installation of the kitchen, the kitchen units - the accessories and apparatus, and the household appliances therein, or the lack of elements foreseen as necessities and/or useful, of STOSA S.P.A., the said manufacturer of kitchen units or the manufacturer of the household appliances - constitute a source of direct responsibility for the installation and the customer with the concurrent exclusion of liability of STOSA S.P.A. - notwithstanding the express responsibility for consumer protection - not proceeding STOSA S.p.a. to the relative installation of the kitchens - of which the non-compliant installation constitutes express clause of exclusion of responsibility for STOSA S.p.a.

PREZZI E DECORRENZA PRICES AND STARTING DATE

I prezzi sono quotati al pubblico IVA esclusa e sono espressi in punti (vedere prima pagina dove è espresso il coefficiente).

Prices are quoted to the public excluding VAT and are expressed in points (see the first page where the coefficient is expressed).

RESI RETURNS

Non verranno accettati resi di merce se non preventivamente richiesti mediante apposito modulo - previa espressa autorizzazione scritta dalla Stosa S.p.a.

Il materiale da rendere dovrà pervenire alla Stosa s.p.a. entro il termine massimo di 90 gg. dalla data della relativa autorizzazione. Lo stato di conservazione della merce resa sarà attentamente verificato all'atto del rientro in sede ed in caso di danni non imputabili alla Stosa s.p.a., non verrà riconosciuto l'accredito corrispondente al valore di detta merce.

Salvo diversi accordi scritti, la merce inviata in sostituzione verrà regolarmente fatturata e darà luogo a regolare pagamento da parte del cliente senza possibilità di compensi di partite; corrispondentemente la merce restituita formerà oggetto di emissione di regolare nota di accredito da parte di Stosa s.p.a. e sarà da questa regolata al cliente a mezzo bonifico bancario. In caso di mancato reso nel termine di 90 giorni la STOSA S.p.a. viene autorizzata ad emettere relativa fatturazione e a richiederne il relativo pagamento - senza alcuna eccezione e contestazione di sorta.

Returned goods will not be accepted unless previously requested through the appropriate form - subject to the expressed written permission of Stosa S.p.a.

The material to be returned must be received by Stosa S.p.a. within a maximum period of 90 days from the date of the relative authorization. The state of conservation of the returned goods will be carefully checked upon return and in the event of damage not attributable to Stosa s.p.a., accreditation corresponding to the value of those goods will not be recognized. Unless otherwise agreed in writing, the goods sent in replacement will be regularly invoiced and with the regular payment by the customer without the possibility of compensation; accordingly, the returned goods will be subject to the issuance of a regular credit note by Stosa S.p.a. and will be paid to the customer by bank transfer.

In the event of failure to return the goods within 90 days, STOSA S.p.a. is authorized to issue the relative invoice and request the related payment - without exception and dispute of any kind.

CONSISTENZA FINITURE CONSISTENCY OF FINISHES

Tutte le finiture potranno subire nel tempo variazioni di colore dovute alla luce, ai vapori e all'invecchiamento e una difformità rispetto allo stato originario di consegna o di rappresentazione nel catalogo non potrà costituire motivo di contestazione e/o vizi del prodotto. Menzionate variazioni non costituiscono né costituiranno vizi o difetti del prodotto stesso. In caso di completamenti della cucina si potranno avere delle differenze di tonalità che comunque tenderanno ad attenuarsi nel tempo - non costituendo anch'essi vizi o difetti dei prodotti. Per i piani in marmo e granito, considerando che il taglio proviene da blocchi naturali, non viene garantita l'uniformità del colore e della grana. Considerando la natura degli elementi, eventuali imperfezioni dovranno essere considerate analizzando il prodotto frontalmente nelle zone a vista ad almeno un metro di distanza in condizioni normali di luce. Questi fattori non potranno costituire motivo di contestazione o di resa del prodotto né vizi o difetti dello stesso.

Ai fini della migliore delucidazione sulle caratteristiche e conservazione del prodotto consegnato viene consegnato unitamente alla cucina che un cd contenente tutte le informazioni e modalità di conforme e adeguata conservazione del prodotto. Ai fini della validità della garanzia il cliente si obbliga a pena di decadenza e validità della garanzia a rispettare gli elenchi gli elenchi e altri documenti e le istruzioni di utilizzo e conservazione del prodotto. Eventuali vizi e difetti del prodotto che sia causata dall'errore - non conforme - contrastante utilizzo del prodotto rispetto alle precauzioni del libretto d'uso e manutenzione dello stesso non potranno costituire oggetto di contestazione.

All finishes may be subject to changes in colour due to light, steam and ageing over time and a deviation from the original condition on delivery or the representation in the catalogue can not constitute grounds for claims and/or product defects. Said changes do not represent nor constitute flaws or defects in the product itself. In the case of kitchen additions differences in tone may occur that will nevertheless tend to fade over time - these do not constitute flaws or defects in the product itself. For marble and granite surfaces, considering the cut comes from natural blocks, the uniformity of colour and grain cannot be guaranteed. Considering the nature of the elements, any imperfections will be considered by analysing the product from the front in the exposed areas at least one meter away in normal light.

These factors can not constitute grounds for a claim or return of the product with flaws or defects.

For a better explanation on the characteristics and conservation of the delivered product, a CD is delivered together with the kitchen that containing all the information and the compliance and adequate conservation methods of the product.

For the purposes of warranty validity, the customer is obligated, subject to revocation and validity of the warranty, to respect the lists and other documents, and the use and maintenance instructions of the product. Possible faults and defects of the product due to the incorrect - non-compliant - contrasting use of the product in relation to the precautions of the use and maintenance manual, can not be disputed.

GARANZIA STOSA THE STOSA WARRANTY

La garanzia è valida per due (2) anni dalla data di acquisto (ai fini dell'applicazione della garanzia è necessario per l'acquirente finale rivolgersi al proprio rivenditore esibendo copia della fattura di vendita in originale quale prova di acquisto).

La garanzia è valida solo nei confronti del primo acquirente e, salvo diverse previsioni e limitazioni contenute nelle Condizioni Generali di Vendita, consiste nella riparazione o sostituzione gratuita di elementi inutilizzabili o difettosi, accertati da Stosa, durante il periodo di validità della garanzia.

Non sono considerati difetti di fabbricazione i danni dovuti a manutenzione ed uso impropri del prodotto. Sul libretto Uso e Manutenzione per il cliente finale, che accompagna i prodotti Stosa, sono riportate le principali precauzioni da adottare. Per ogni maggior dettaglio circa le condizioni di garanzia si rinvia alle Condizioni Generali di Vendita. Per tutti gli eventi non espressamente previsti dalla presente garanzia, si applicano le disposizioni contenute nella legislazione vigente.

The warranty is valid for two (2) years from the date of purchase (for the purpose of application of the warranty it is necessary for the end user to contact the retailer with a copy of the original sales invoice as proof of purchase). The warranty is only valid when used by the first buyer of the product and, subject to different provisions contained in the General Conditions of Sale, covers repair or replacement, free of charge, of unusable or defective items ascertained by Stosa during the warranty period.

Damage caused by improper maintenance or incorrect use of the product is not considered a manufacturing defect. The Use and Maintenance Manual for the end user, that comes with Stosa products, describes the main precautions to be taken. For further details about the warranty conditions, please read the General Conditions of Sale.

For all events not expressly covered by this warranty, the provisions of current legislation will apply.

Informazioni generali

General informations

TRASPORTO E SPEDIZIONI TRANSPORT AND SHIPPING

Il ricevente ha l'obbligo di controllarne l'integrità dei pacchi e dei colli e della merce al momento dell'arrivo e in caso di danni dovuti al trasporto o ad eventuali discordanze della merce rispetto ai documenti di trasporto, lo stesso ricevente deve a pena di decadenza effettuare la relativa segnalazione all'autista/vettore mediante annotazione sui documenti di trasporto che accompagnano la merce. Con la firma del documento di trasporto, in mancanza delle annotazioni di cui sopra, viene espressamente dichiarata la perfetta integrità e completezza della merce inviata e dei pacchi e dei colli nei quali la medesima è contenuta.

The recipient is obliged to check the integrity of the parcels and packages and the goods on receipt and in the event of shipping damage or for any discrepancy of the goods with respect to the transport documents, the recipient must, under penalty of forfeiture, signal to the driver/carrier by way of a statement on the shipping documents accompanying the goods. With the signing of the transport documents, in the absence of the above statement, the integrity and completeness of the goods sent and the parcels and packages in which it is contained, is expressly declared.

RECLAMI ED AZIONI CLAIMS AND ACTIONS

I vizi e i difetti del prodotto devono essere denunciati alla Stosa S.p.a. nei termini di legge (8 giorni dalla consegna) mediante apposito modulo consegnato integralmente alla presente informativa. Non verranno accettati resi di merce se non preventivamente segnalati mediante apposito modulo od espressamente autorizzati per iscritto dalla Stosa S.p.a.. I resi autorizzati dovranno essere restituiti alla Stosa S.p.a. entro 90 giorni dalla data della relativa autorizzazione alle condizioni di cui infra. Eventuali contestazioni del prodotto non potranno costituire condizione legittimamente il mancato pagamento – la sospensione o il ritardo nello stesso. Non si fornisce alcuna garanzia per i mobili in cui l' incasso degli elettrodomestici non venga effettuato da Stosa Spa. A tal fine l'azione di responsabilità dovrà essere esercitata direttamente nei confronti dell'installazione il quale unitamente al cliente saranno obbligati a rispettare tutte le precauzioni e le modalità di installazione previste dai singoli produttori di elettrodomestici.

La garanzia del prodotto decorre dalla data di consegna.

Il prodotto di intenderà completamente accettato e privo di vizi e/o difetti qualora non abbia esperimento la procedura di cui alle condizioni di trasporto – e comunque in assenza di tempestiva contestazione nei confronti di Stosa s.p.a. nei menzionati 8 giorni dalla consegna. Qualora si versi nelle ipotesi di applicazione del codice di consumo il prodotto è da intendersi accettato senza riserve – e quindi privo di vizi e difetti - decorsi due (2) mesi dalla consegna.

Il foro competente ed esclusivo per la risoluzione di qualsivoglia controversia di qualsiasi natura sarà quello di SIENA.

The faults and defects of the product must be reported to Stosa S.p.A. within the terms of the law (8 days from delivery) using the form given along with the present information. Returned goods will not be accepted unless previously signalled through the appropriate form or expressly authorized in writing by Stosa S.p.A.. Authorized returns must be returned to Stosa S.p.A. within 90 days from the date of its authorization in accordance with the conditions referred to below.

Any disputes of the product can not legitimately be conditions of non-payment - or the suspension or delay of payment.

No warranty is given for furniture where the collection of the household appliances is not carried out by Stosa S.p.a.. To this end, liability actions must be brought directly on the installation which, together with the customer, will be obliged to comply with all precautions and installation procedures provided by the individual appliance manufacturers.

The product warranty begins on the date of delivery. The product is deemed fully accepted and free of flaws and/or defects in the event the procedure referred to in the transport conditions has not been carried out - and in any case in the absence of timely notification against Stosa s.p.a. within the mentioned 8 days from delivery.

In the event of application of the consumer code, the product is to be considered unconditionally accepted - and therefore devoid of flaws and defects - two (2) months after delivery.

The competent court for the resolution of any dispute of any nature will be that of SIENA.

PAGAMENTI PAYMENTS

I pagamenti devono essere effettuati in base alle modalità stabilite nel contratto di fornitura, senza apportare arrotondamenti o sconti rispetto al totale delle relative fatture. La Stosa S.p.A. si riserva il diritto di sospendere le consegne della merce in qualsiasi momento qualora si verifichi un ritardo e/o mancato pagamento anche di una sola fornitura, anche parziale, di quelle in scadenza o di quelle pregresse, ovvero, in caso di mancato rispetto dei termini di pagamento e/o posticipazioni degli stessi o di riduzione delle garanzie o nei casi di verificaone di fatti o circostanza che ledano o riducano la fiducia nel cliente e nella sua solvibilità. In caso anche di una singola inadempienza della controparte – anche riguardante i termini di pagamento, la Stosa S.p.a. si riserva inoltre la facoltà di modificare unilateralmente le modalità ed i termini del contratto e di pagamento originariamente pattuiti. In caso di mancato pagamento, anche parziale, le parti convengono espressamente – costituendo espresso accordo in tal senso – che in caso di mancato o ritardato pagamento saranno applicati gli interessi moratori previsti in caso di ritardato pagamento nelle transazioni commerciali. L'applicazione è aggiornata sulla base del DLGS 9 novembre 2012, n. 192 e del D.L. 24 gennaio 2012, n. 1, convertito con modificazioni dalla L. 24 marzo 2012, n. 27 e sarà aggiornata secondo le disposizioni di legge al tempo dell'applicazione in vigore.

Payments must be made in accordance with the methods laid down in the supply contract, without the application of discounts or the rounding off of the total of the corresponding invoices.

Stosa S.p.A. reserve the right to suspend deliveries of goods at any time if there is a delay and/or failure to pay even a single supply, even partial, of those due to expire or already expired, or, in the event of failure to meet payment deadlines and/or postponements thereof or reduction of collateral or in the verification of facts or circumstances which adversely affect or reduce the faith in the customer and in their solvency. In the event of even a single default on the part of the counterparty - also concerning the payment terms, Stosa S.p.a. also reserve the right to unilaterally change the originally agreed terms and conditions of the contract and payment.

In the event of non-payment, even partial, the parties expressly agree - constituting express agreement to that effect - that in the event of late or non-payment interest on arrears will be charged provided in the event of late payment in commercial transactions. The application is updated on the basis of the Legislative Decree 9 November 2012, n. 192 and Legislative Decree January 24, 2012, n. 1, converted with amendments by Law March 24, 2012, n. 27 and will be updated according to the legal provisions in force at the time of application.

INFORMAZIONI TECNICHE TECHNICAL INFORMATIONS

Gli ordini possono riguardare anche elementi fuori misura ed anche separatamente gli elementi accessori. Per elemento fuori misura si intende un articolo ricavabile dalla figura standard, come indicata nel listino, mediante variazione di una o più dimensioni. La realizzazione di eventuali elementi su misura è rimessa alla valutazione discrezionale di Stosa S.p.a. che si riserva di verificare la fattibilità tecnica di quanto richiesto nell'ordine stesso. La richiesta di realizzazione di elemento su misura dovrà, in ogni caso, essere accompagnata dal disegno del prodotto – a carico dello stesso committente. Gli ordini relativi ad elementi su misura non potranno in nessun caso essere annullati o disdetti dal committente, per il quale Stosa S.p.a. procederà comunque alla consegna della merce ordinata e all'addebito del relativo costo. Le caratteristiche della merce fornita sono quelle riportate, modello per modello, nel listino in vigore. La merce fornita potrà, tuttavia, presentare caratteristiche parzialmente difformi rispetto a quelle indicate nel listino e comunque risultare non del tutto identica ai campioni che eventualmente fossero stati visionati in occasione della effettuazione dell'ordine, dovendosi riconoscere margini di tolleranza per quanto concerne i colori e le tonalità per elementi legno o laccati e per gli altri elementi naturali. La società Stosa S.p.a. declina e non si assume alcuna responsabilità circa la tenuta dei supporti a scomparsa e delle attaccaglie per pensili che dipendessero da insufficiente consistenza della parete su cui venissero applicati gli stessi. Conseguentemente e prima della effettuazione dell'ordine è opportuno che l' acquirente verifichi l'idoneità della parete cui gli stessi dovranno essere installati in relazione al peso dello stesso.

Orders can also cover outsized elements and accessory elements separately.

Outsized elements are intended as articles obtainable from the standard form, as indicated in the price list, varying one or more dimensions. The production of any made to measure elements is left to the discretion of Stosa S.p.a. the reserve the right to verify the technical feasibility of that requested in the order. The request for the realization of a made to measure element must in any case be accompanied by the drawing of the product - borne by the said client. Orders for made to measure elements may in no case be terminated or cancelled by the customer, for which Stosa S.p.a. will however proceed to the delivery of the goods ordered and debit the related cost.

The characteristics of the goods supplied are those reported, model by model, in the current price list.

However, the goods supplied may have characteristics partially dissimilar to those illustrated in the price list and may not be completely identical to the samples possibly inspected during the order process, such to acknowledge tolerances regarding the colours and shades for wooden or lacquered elements and other natural elements. The company Stosa S.p.A. disclaims and assumes no responsibility for the hold of retractable supports and hangers for wall units that depend on the insufficient consistency of the wall on which they are applied.

Consequently and prior to the execution of the order, the buyer should verify the suitability of the wall on which they will be installed in relation to the weight of the same.

NOTIZIE UTILI USEFUL NEWS

Gli elementi in massello o materiale impiallacciato, risentono della naturale variabilità della struttura del legno e delle condizioni climatiche e di umidità dell'ambiente nel quale sono installati. In condizioni di uso normale, piccole variazioni dimensionali e cromatiche sono espressamente accettate dal consumatore. Variazioni di colore e tonalità, oppure imperfezioni (tipo piccoli nodi), sono connotate alla piacevolezza del legno stesso e non costituiscono vizio e/o difetto del prodotto. Alla fine del loro utilizzo non disperdere i mobili nell'ambiente, ma contattare un azienda di smaltimento rifiuti solidi urbani per il loro trasporto di discarica o recupero. Il consumatore è tenuto a seguire scrupolosamente le indicazioni e i suggerimenti riportati dalla corretta cura manutenzione e posizionamento del prodotto in ambiente consono e idoneo – conforme allo standard qualitativo del prodotto prescelto. Eventuali danneggiamenti e vizi e/o difetti del prodotto dovuti all' uso improprio dello stesso – alla sua erronea dislocazione in ambiente insalubre - umido - non idoneo - o alla non conforme manutenzione e pulizia dello stesso – non potranno essere eccepti e contestati alla produttrice - e non potrà darsi luogo a sostituzioni o interventi - neanche se il prodotto è in garanzia.

A tal fine la STOSA S.p.a. specifica di come per le caratteristiche del prodotto così come per l'alta qualità del medesimo è consigliato l'utilizzo in ambiente salubre con una percentuale di umidità che non si mantenga per lunghi periodi al di sotto del 40 % o al di sopra del 70% - Eventuali vizi o difetti del prodotto o dei singoli elementi o il non conforma funzionamento dello stesso – se utilizzato contrariamente o diversamente da quanto sopra – non potrà essere oggetto di contestazione e costituirà condizione di esclusione dalla garanzia.

The elements in solid wood or veneered material, are affected by the natural variability of the wood structure, the weather conditions and the humidity of the environment in which they are installed. In normal use conditions, in an appropriate environment, small variations in size and colour are expressly accepted by the consumer. Variations in colour and tone, or imperfections (such as small knots), are connotations to the pleasantness of the wood itself and do not represent flaws and/or defects of the product. At the end of their use, do not discard the furniture in the environment, but contact a solid waste disposal company for their transport to the landfill or for recycling. The consumer is required to carefully follow the instructions and suggestions given by the correct maintenance and placement of the product in an appropriate and suitable environment - compliant with the quality standard of the chosen product. Any damage, flaws and/or defects of the product due to the misuse of the same - to its incorrect placement in an environment that is unhealthy - damp - unsuitable - or its non-compliant maintenance and cleaning - can not be contested and disputed to the manufacturer - and will not give rise to replacements or interventions - even if the product is under warranty. To this end STOSA S.p.A. specify that as for the characteristics of the product as well as for the high quality of the same, recommend use in a healthy environment with a humidity percentage that does not continue for long periods below 40% or above 70% - Any flaws or defects of the product or of the individual elements, or the non-compliant function of the same - whether used contrary or otherwise to the above - cannot be contested and will constitute exclusion from the warranty.

Informazioni generali

General informations

ISTRUZIONI DI SINTESI PER L'USO, LA MANUTENZIONE E PULIZIA BRIEF INSTRUCTIONS FOR USE, MAINTENANCE AND CLEANING

Dettagli sono contenuti nella scheda "Uso e Manutenzione" fornita con la cucina ; questa scheda su supporto cd viene consegnata al cliente finale unitamente al prodotto. In generale:

- Mantenere costantemente la temperatura e l'umidità ambientale idonea al prodotto acquistato.
- Per ritardare il processo di variazione di colore nel tempo al quale il legno e il laccato sono sottoposti, si consiglia di non esporre la cucina alla luce diretta del sole.
- La pulizia di tutta la cucina può effettuarsi con un panno morbido con l'aggiunta di detersivo neutro con una concentrazione al massimo del (20% di prodotto) o più semplicemente un panno in microfibra. Si invita evitare sempre l'uso di creme abrasive o l'uso di vapore.
- Evitare di lasciare per lungo termine i liquidi - gli alimenti e i liquidi per la pulizia - sulle superfici della cucina la permanenza degli stessi sulle superfici potrebbe lasciare macchie e determinare variazioni di colore del prodotto.
- Si raccomanda di asciugare perfettamente il prodotto e le superfici subito dopo la pulizia.
- Non porre mai a diretto contatto dei piani di lavoro corpi o utensili e pentole calde, ciò può provocare una deformazione del prodotto e della creazione di "macchie di calore".
- Non usare pulitori a vapore sulla stuccatura delle fughe di piani in Art-Decor o su altre superfici che non permettano tale utilizzo.
- Non potranno sostituire vizi e/o difetti del prodotto tutti quelli derivati dalla non conforme ed adeguata erronea non conforme manutenzione pulizia e cura del prodotto e qualora il cliente non abbia ottemperato ad un rispettoso uso e manutenzione del prodotto in ossequio alle istruzioni di cui sopra – Il mancato rispetto delle menzionate istruzione di cura manutenzione pulizia utilizzo costituisce clausola espressa di esclusione di responsabilità per vizi e difetti del prodotto – da tale mancanza determinati - della produttrice STOSA Spa.

Details are contained in the "Use and Maintenance" card supplied with the kitchen,this card on CD is delivered to the end customer with the product. In general:

- Constantly maintain the temperature and the environmental humidity suitable for the product purchased.
- To delay the colour variation over time to which the wood and lacquered elements are subjected, it is advisable to avoid exposing the kitchen to direct sunlight.
- The entire kitchen can be cleaned with a soft cloth with the addition of neutral detergent with a maximum concentration of 20% of product, or simply with a microfibre cloth. The use of abrasive creams or the use of steam cleaners should always be avoided.
- Avoid leaving liquids - foods and cleaning fluids - for prolonged periods on the kitchen surfaces - the permanence of the same on the surface could leave stains and determine variations in product colour.
- The product and surfaces should be perfectly dried immediately after cleaning.
- Do not place hot items or utensils and pots in direct contact with the worktops, this can cause deformation of the product and the creation of "marks".
- Do not use steam cleaners on the grouting of Art-Decor worktops or other surfaces that do not allow such use.
- All that derived from the non-compliant and inadequate maintenance, cleaning and care of the product and the failure of the customer to fulfil a respectful use and maintain of the product in accordance with the aforementioned instructions, do not constitute flaws and/or defects of the product - Failure to follow the aforementioned care, maintenance, cleaning, and use instruction constitutes an express exclusion of liability for product flaws and defects - from that determined failure - of the manufacturer STOSA S.p.a.

ELETTRODOMESTICI HOUSEHOLD APPLIANCES

Per l'installazione e l'utilizzo degli elettrodomestici si richiede di prestare particolare attenzione e fare esclusivo riferimento in modo scrupoloso a quanto prescritto in fase di installazione e di utilizzo dalle case costruttrici negli specifici manuali in dotazione. Le ditte produttrici di elettrodomestici forniscono garanzia e assistenza per i loro prodotti, perciò ogni richiesta di intervento va inoltrata direttamente ad esse - come indicato nei suddetti manuali.

Sia l'installatore che il cliente si devono attenere scrupolosamente alle indicazioni di installazione contenute nel libretto installazione degli elettrodomestici. Ulteriori ed eventuali elementi ritenuti necessari per l'istallazione degli elettrodomestici – potranno anche far parte del listino degli accessori prodotti e forniti da Stosa S.p.a. disponibili nel catalogo nella parte "accessori" che potranno eventualmente essere acquistati anche separatamente e distintamente dalla cucina. La gamma completa degli elettrodomestici è disponibile nello specifico listino "Elettrodomestici".

For the installation and use of electrical appliances, please pay special attention and make exclusive and scrupulous reference, during installation and use, to that prescribed by the manufacturers in the specific manuals supplied.

The manufacturers of electrical appliances supply guarantees and assistance for their products, therefore any request for assistance should be addressed directly to them - as indicated in the above mentioned manuals.

Both the installer and the customer must strictly follow the installation instructions contained in the installation booklet of the electrical appliances. Additional and possible elements deemed necessary for the installation of the electrical appliances - may also be part of the price list of accessories manufactured and supplied by Stosa S.p.a.

Available in the accessories section of the catalogue - items that could possibly be purchased separately and distinctly from the kitchen. The full range of electrical appliances is available in the specific "Appliances" price list.

LAVASTOVIGLIE DISHWASHERS

Non aprire lo sportello appena finito il ciclo di lavaggio ed aspettare il raffreddamento delle stoviglie, in quanto il vapore può danneggiare il piano e le pareti adiacenti alla lavastoviglie. Le ditte produttrici forniscono un adesivo protettivo da applicare sotto al top – al fine del miglior utilizzo – come da allegate istruzioni. Eventuali danneggiamenti del piano di lavoro e delle parti adiacenti dovute al vapore non saranno oggetto di sostituzioni in garanzia.

Do not open the door when the washing cycle has just finished, wait for the dishes to cool as steam can damage the worktop and walls adjacent to the dishwasher. The manufacturers provide a protective adhesive to be applied under the worktop - for the best use - as per the attached instructions. Any damage to the worktop and the adjacent parts caused by hot steam, will not be subject to replacement under warranty.

CAPPE HOODS

Il motore della cappa deve essere sempre acceso per tutta la durata del tempo di utilizzo del piano cottura, onde permettere l'aspirazione dei fumi e dei vapori. Eventuali danneggiamenti dovuti ad infiltrazioni di vapore non saranno oggetto di sostituzioni in garanzia. L'installazione della cappa di aspirazione dovrà essere fatta senza pregiudicare in alcun modo la capacità di aspirazione che limiterebbe l'evacuazione dei fumi e vapore .

L'installazione delle cappe – qualora siano presenti vizi e difetti visibili del prodotto - costituirà esonerato da garanzia e esclusione della stessa. Si consiglia nel caso di contestare il prodotto senza procedere al relativo montaggio.

The motor of the hood must always be turned on all the time the hob is being used, in order to allow the aspiration of fumes and vapours. Any damage due to the infiltration of steam will not be subject to replacement under warranty. The installation of the extraction hood must be made without jeopardizing in any way the extraction capacity which would limit the evacuation of the fumes and steam.

The installation of hoods - in the presence of visible flaws and defects of the product - constitute a waiver of the warranty and exclusion of the same. In this case it is recommended to contest the product without proceed with the relative fitting.

LAVELLI SINK UNITS

Il verso di lavelli Dx o Sx è determinato dalla posizione delle vasche.

The right or left position of the sinks is determined by the position of the basins.

TOPS WORKTOPS

Gli elementi base sono quotati al prezzo di listino escluso tops e alzatina, da aggiungere al metro lineare.

I fori per piani cottura e lavelli che non prevedono la fornitura di elettrodomestici vengono addebitati (vedere pagina Fuori Misura).

The cut-outs for hobs and sinks that do not involve the supply of appliances will be charged (see Custom-sized page).

ORDINI ORDERS

L'accettazione degli ordini è subordinata all'approvazione della Stosa S.p.A.

La commissione deve essere completata in tutte le sue parti – puntualmente e secondo le specifiche istruzioni - analiticamente in tutte le pagine – ivi compreso nella pagina retrostante il disegno quotato in pianta per l'esatta realizzazione dei tops.

Per tutto quanto non disciplinato nella presente si rinvia alla disposizioni generali di vendita alle eventuali specifiche condizioni e alle disposizioni codicistiche.

The acceptance of orders is subject to the approval of Stosa S.p.A.

The order must be completed in all its parts - punctually and according to the specific instructions - analytically on all pages - including the page behind the dimensioned plan drawing for the exact realization of the worktops.

For all matters not governed by the present, reference should be made to the general provisions of sale, to any specific conditions and to the provisions of the Civil Code.

CONDIZIONI GENERALI DI VENDITA

GENERAL CONDITIONS OF SALE

8.	ELEMENTI FUORI MISURA
8.1	Gli ordini possono riguardare anche elementi fuori misura ed anche separatamente gli elementi accessori. Per elemento fuori misura si intende un articolo ricavabile dalla figura standard, come indicata nel listino, mediante variazione di una o più dimensioni. La realizzazione di eventuali elementi su misura è rimessa alla valutazione discrezionale di STOSA S.p.A. che si riserva di verificare la fattibilità tecnica di quanto richiesto nell’ordine stesso. La richiesta di realizzazione di elemento su misura dovrà, in ogni caso, essere accompagnata dal disegno del prodotto a carico dello stesso committente.
8.2	Gli ordini relativi ad elementi su misura non potranno in nessun caso essere annullati o disdetti dal committente, per il quale STOSA S.p.A. procederà comunque alla consegna della merce ordinata e all’addebito del relativo costo.
9.	GARANZIE E RECLAMI
9.1	Le caratteristiche della merce fornita sono quelle riportate, modello per modello, nel listino in vigore, che costituisce parte integrante e sostanziale dei singoli ordini anche se non espressamente richiamato ed allegato agli stessi.
9.2	STOSA S.p.A. informa ed il cliente riconosce che la merce fornita potrà, tuttavia, presentare caratteristiche parzialmente difformi rispetto a quelle indicate nel listino e/o nei cataloghi e comunque risultare non del tutto identica ai campioni che eventualmente fossero stati visionati in occasione dell’effettuazione dell’ordine, dovendosi riconoscere margini di tolleranza per quanto concerne i colori e le tonalità per elementi legno o laccati e per gli altri elementi naturali, ed avendo i listini e gli eventuali campioni dimostrativi carattere puramente indicativo. In tal senso, il cliente accetta espressamente eventuali variazioni dimensionali e cromatiche e riconosce che variazioni di colore e tonalità oppure imperfezioni (tipo piccoli nodi) sono caratteristiche del legno che ne determinano la piacevolezza e non costituiscono vizio e/o difetto del prodotto.
9.3	Eventuali vizi o difetti delle merci consegnate devono essere segnalati per iscritto dal Cliente, a pena di nullità della contestazione, entro otto giorni dal ricevimento della merce o dalla scoperta dei vizi, se occulti.

9.4	La garanzia Stosa, alle condizioni di seguito indicate, è valida per due (2) anni dalla data di acquisto e copre i difetti originari di fabbricazione. Ai fini dell’applicazione della garanzia è necessario per l’acquirente finale esibire copia della fattura di vendita in originale quale prova di acquisto, che sarà riscontrata con corrispondente fattura di vendita emessa a carico del Rivenditore. Fermo restando quanto previsto al successivo punto 9.5, nei primi 24 mesi dalla data di acquisto del prodotto l’acquirente finale è tutelato dalla Garanzia Legale che prevede la riparazione gratuita o la sostituzione del Prodotto non conforme al contratto (Art. 130 del Codice del Consumo italiano).
-----	---

La garanzia comporta unicamente il diritto alla riparazione o la sostituzione dei prodotti riconosciuti difettosi da STOSA nei tempi tecnici normalmente occorrenti, alle condizioni e nel luogo di consegna originari. In ogni caso, per eventuali difetti e/o non conformità dei prodotti, sarà concesso a STOSA da parte del cliente, prima di invocare la risoluzione del contratto, un termine di almeno 60 (sessanta) giorni per rimediare. La riparazione o la sostituzione dei prodotti cui siano stati riconosciuti difetti di fabbricazione esaurisce ogni responsabilità di STOSA nei confronti del Cliente. Solo per le vendite nel mercato italiano, a decorrere dall’inizio del terzo anno dalla data di acquisto e fino al compimento del quinto anno dalla data di acquisto la garanzia è limitata a quanto previsto dalla promozione “5 anni zero pensieri”, per la quale si fa rinvio ai relativi fogli informativi. Per le vendite relative ai “contract project” (per tali intendendosi le vendite su progetto di almeno di n. 15 cucine allo stesso acquirente) la garanzia è limitata a quella legale di due anni, salvo diverso accordo scritto tra le parti. Per le vendite relative alle cucine destinate agli showrooms (cucine di mostra) la garanzia è limitata a quella legale di due anni a favore esclusivamente del Rivenditore. In ogni caso nessuna ulteriore pretesa a titolo di risarcimento danni o ad altro titolo potrà essere fatta valere dal Cliente nei confronti di STOSA. In nessun caso sarà concesso al cliente di ridurre il prezzo di vendita dei prodotti per vizi e/o non conformità, salvo consenso scritto di STOSA.

9.5 La garanzia non copre il normale degrado e l’usura dei prodotti, in particolare tagli, graffi e scheggiature, danni provocati da urti o incidenti come pure ogni difetto o mancanza di qualità dovuti a od influenzati da immagazzinaggio od utilizzo errati. Il Rivenditore deve seguire attentamente le istruzioni di montaggio e di installazione del Prodotto. Il cliente finale è tenuto a seguire scrupolosamente le eventuali indicazioni e suggerimenti di STOSA S.p.A. sulla corretta cura, manutenzione e posizionamento del prodotto in ambiente consono e idoneo, conforme allo standard qualitativo del prodotto prescelto. A tale scopo è messo a disposizione un portale e un libretto Uso e Manutenzione per il cliente finale. La garanzia è valida per prodotti destinati ad un uso domestico. Eventuali danneggiamenti del prodotto dovuti al suo erroneo montaggio, alla sua erronea dislocazione in ambiente insalubre, umido e/o non idoneo e/o alla sua non conforme manutenzione e pulizia, alla sua manomissione o modificazione, sono esclusi dalla garanzia, non potranno essere eccettiti e contestati a STOSA S.p.A. e non potrà darsi luogo a sostituzioni o interventi, neanche se il prodotto è in garanzia. La garanzia non viene applicata se il Prodotto è stato collocato in ambienti umidi o all’esterno. A tal fine, STOSA S.p.A. specifica sin d’ora che per le caratteristiche del prodotto così come per l’alta qualità del medesimo è consigliato l’utilizzo in ambiente salubre con una percentuale di umidità che non si mantenga per lunghi periodi al di sotto del 40% o al di sopra del 70%. In ogni caso il cliente non potrà far valere la garanzia verso STOSA se il prezzo dei Prodotti non sia stato integralmente corrisposto alle condizioni e nei termini pattuiti, anche nel caso in cui la mancata corresponsione del prezzo alle condizioni e nei termini pattuiti si riferisca a prodotti diversi da quelli per i quali il cliente intende far valere la garanzia. La garanzia non comprende inoltre:

- responsabilità in ordine al montaggio dei prodotti;
- i danni provocati o agevolati da dolo e/o colpa grave del Rivenditore e/o dell’acquirente finale e/o dei soggetti ai quali il mobile è affidato a qualunque titolo, anche temporaneamente;
- negligenza dell’acquirente finale;
- tutte le prestazioni di manutenzione ordinaria e/o straordinaria, ed in particolare la manodopera necessaria per provvedere alla eventuale sostituzione o riparazione del Prodotto;
- i danni causati da animali domestici.
- tutte le prestazioni previste obbligatoriamente dalla garanzia legale offerta dal costruttore/produttore del componente (ad esempio elettrodomestici); per i prodotti di commercializzazione assistiti da loro certificati di garanzia, questi ultimi dovranno essere fatti valere nei confronti dei relativi costruttori. Si declina ogni responsabilità in ordine al montaggio dei prodotti.

- i danni verificatisi in conseguenza di eruzioni vulcaniche, terremoti, calamità naturali, eventi atmosferici, atti vandalici e/o dolosi, atti di guerra, insurrezioni, tumulti popolari, scioperi, sommosse, occupazioni militari nonché sviluppo, comunque insorto, controllato o meno, di energia nucleare o di radioattività.
- Sono altresì esclusi dalle coperture offerte dall’Estensione di Garanzia:
 - tutti gli elettrodomestici anche se installati ad incasso nel mobile cucina;
 - maniglie, rubinetti, lavelli, top in Okite, piano di marmo e in generale tutti quegli elementi facenti parte del mobile ma non direttamente prodotti da Stosa S.p.A.;
 - meccanismi elettrici ed elettronici, luci, lampade, led.
 - tutti gli accessori quali ad esempio mensole, cestini, sedie, attaccapanni, vetri, specchi; STOSA declina e non si assume alcuna responsabilità circa la tenuta dei supporti a scomparsa e delle attaccaglie per pensili in caso di insufficiente consistenza della parete su cui venissero applicati gli stessi. Conseguentemente, è opportuno che prima dell’effettuazione dell’ordine l’acquirente verifichi l’idoneità della parete su cui il prodotto dovrà essere installato in relazione al peso dello stesso.
 - tutti gli eventi su beni diversi da quelli oggetto della copertura.

CONDIZIONI GENERALI DI VENDITA

GENERAL CONDITIONS OF SALE

1.	GENERALITÀ
1.1	Le presenti condizioni generali di vendita, ove non derogate da condizioni particolari espressamente accettate per iscritto da STOSA S.p.A. con sede legale in Barberino Val D’Elsa (FI - Italia), Via C. Colombo n. 1, e sede amministrativa in Radicofani (SI - Italia), S.R. Cassia Km. 149.500, Part. IVA 04494400486, regolano le vendite dei prodotti di STOSA S.p.A.. Le presenti condizioni generali di vendita, pertanto, devono intendersi parte integrante e sostanziale di tutti i contratti di STOSA S.p.A., anche quando gli ordini vengano assunti telefonicamente, verbalmente, a mezzo fax, e-mail o in altra forma, e dovranno ritenersi prevalenti su qualsiasi altra eventuale condizione generale o particolare di vendita predisposta dal cliente.
2.	OGGETTO DELLA FORNITURA
2.1	La fornitura comprende solamente i materiali ed i quantitativi indicati nella conferma d’ordine di STOSA S.p.A. o in altre comunicazioni scritte da STOSA S.p.A. successivamente all’ordine. Il cliente è responsabile della scelta dei prodotti ordinati e dell’utilizzo degli stessi per le proprie necessità ed applicazioni.
3.	OFFERTE E ORDINI
3.1	Le offerte di STOSA S.p.A. si intendono valide per 60 giorni se non diversamente indicato nell’offerta stessa. Schemi, illustrazioni, dimensioni, pesi, e descrizione dei prodotti, oltre che i dati tecnici in essi indicati, sono di carattere provvisorio; i colori sono puramente indicativi e potrebbero non corrispondere al colore reale. Tutti i predetti dati non sono quindi vincolanti per STOSA S.p.A. se non previa espressa conferma scritta da parte della stessa STOSA S.p.A. Solo la conferma d’ordine di STOSA S.p.A. è vincolante.
3.2	Gli ordini dovranno essere trasmessi a STOSAS.p.A. per iscritto (fax o e-mail), sottoscritti dal cliente e si intenderanno fermi fino alla conferma. Si intenderanno confermati soltanto gli ordini espressamente accettati per iscritto da STOSA S.p.A. Qualora STOSA S.p.A. confermasse l’ordine per iscritto indicando delle modifiche rispetto all’ordine, le modifiche si considereranno tacitamente accettate trascorsi 3 (tre) giorni dal ricevimento della conferma senza che il cliente abbia manifestato il suo dissenso per iscritto. Eventuali modifiche o aggiunte all’ordine avranno valore solo se verranno inserite da STOSA S.p.A. nella conferma d’ordine.
4.	PREZZI
4.1	I prezzi saranno quelli risultanti dalla conferma d’ordine di STOSA S.p.A..
5.	PAGAMENTI
5.1	Le modalità di pagamento, se non diversamente pattuite per iscritto, saranno le seguenti: 50% all’ordine e 50% alla data di invio dell’awiso di merce pronta. In caso di ordini o conferme d’ordine che prevedano consegne frazionate, i termini di pagamento indicati nell’ordine o nella conferma d’ordine varranno per ciascuna consegna parziale. Il ritardato pagamento, totale o parziale, da parte del cliente, darà facoltà a STOSA di risolvere con effetto immediato il contratto e comporterà comunque il diritto di STOSA S.p.A. di farsi corrispondere gli interessi nella misura prevista dal D. Lgs. 231/2002 e successive modificazioni ed integrazioni, oltre al risarcimento del danno.
5.2	In caso di ritardato pagamento totale o parziale da parte del cliente, sarà inoltre facoltà di STOSA S.p.A. sospendere gli ordini e/o le consegne parziali in corso, anche se relativi a diverse forniture ed anche in deroga a quanto previsto dall’art. 1460 c.c., con espressa rinuncia da parte del cliente al risarcimento di ogni eventuale danno conseguente, salvo il caso di dolo o colpa grave di STOSA S.p.A.. In nessun caso sarà concesso al cliente di sospendere o ritardare i pagamenti, neppure in caso di contestazione, reclamo o controversia.
6.	TERMINI DI CONSEGNA
6.1	I tempi di consegna indicati nella conferma d’ordine devono intendersi meramente indicativi e non vincolanti. Essi variano a seconda del tipo di materiale e di lavorazione ordinato.
6.2	Fermo restando che STOSA S.p.A. farà tutto quanto in suo potere per consegnare la merce entro i termini indicati nella conferma d’ordine, in nessun caso STOSA S.p.A. sarà responsabile di danni direttamente o indirettamente derivanti al cliente da ritardi nella consegna della merce che siano contenuti entro i trenta giorni dalla data di consegna indicata nella conferma d’ordine, e ciò salvo il caso di dolo o colpa grave.
6.3	La data presunta di consegna verrà indicata sulla conferma d’ordine. La consegna potrà essere prorogata o sospesa nel caso in cui il cliente non sia in regola con i pagamenti, in conformità a quanto previsto dall’articolo 5 delle presenti condizioni generali di vendita.
6.4	Qualora il cliente dovesse richiedere delle modifiche ai prodotti dopo la conferma d’ordine, è insindacabile facoltà di STOSA S.p.A. accettare o meno la richiesta di modifica; in caso di accettazione da parte di STOSA S.p.A., i termini di consegna originariamente indicati, comunque non tassativi, verranno automaticamente prorogati per un periodo di tempo pari a quello normalmente necessario per STOSA S.p.A. ad effettuare le richieste modifiche.
7.	CONSEGNA E PASSAGGIO DEI RISCHI
7.1	Salvo diverso accordo scritto tra le parti, la consegna della merce nel territorio italiano avviene a cura e spese di STOSA S.p.A.. In ogni caso il trasporto non comprende lo scarico delle merci, il facchinaggio, la sponda idraulica e tutti i rischi di perdita o deterioramento della merce connessi a tali operazioni che saranno ad esclusivo carico del Cliente. Per quanto riguarda la consegna della merce in territori esteri, indipendentemente da quanto pattuito in ordine alle spese di trasporto e/o modalità di pagamento e/o consegna, la consegna della merce ed il contemporaneo passaggio dei rischi si intendono effettuati ex works (EXW - INCOTERMS 2010), presso lo stabilimento di STOSA S.p.A. in Radicofani (SI), con il caricamento della stessa sui mezzi di trasporto diretti al cliente. Pertanto, nel caso di ritardi nella consegna, di danneggiamento o perdita della merce durante il relativo trasporto, i relativi reclami dovranno essere rivolti dal cliente direttamente al trasportatore, anche se lo stesso sia stato incaricato da STOSA S.p.A.. In ogni caso il trasporto non comprende lo scarico delle merci, il facchinaggio, la sponda idraulica e tutti i rischi di perdita o deterioramento della merce che saranno ad esclusivo carico del Cliente dal momento del carico della merce presso lo stabilimento di STOSA.
7.2	Il mancato ritiro dei prodotti, o la mancata disponibilità del cliente a ricevere la consegna della merce, entro il termine di 15 (quindici) giorni dalla data della comunicazione di merce pronta di STOSA S.p.A. comporterà il diritto di STOSA S.p.A. di chiedere al cliente una penale di Euro 100,00 (cento/00) per ogni giorno di giacenza, salvo il risarcimento del maggior danno, restando inteso che dal suddetto termine avverrà comunque il passaggio dei rischi a carico del cliente relativamente ai prodotti giacenti presso i magazzini di STOSA S.p.A..
7.3	Impregiudicato quanto previsto al precedente articolo 7.1 e salva diversa pattuizione scritta tra STOSA S.p.A. e il cliente, la prima si occuperà, a sua cura e spese, del trasporto del prodotto/dei prodotti fino al luogo richiesto dal cliente, facendosi carico anche di eventuali oneri di esportazione; ogni onere e adempimento doganale e fiscale relativo all’importazione nel Paese di destinazione sarà viceversa a carico del cliente.

1.	ABSTRACT
1.1	Where no exceptions are made by particular conditions expressly accepted in writing by STOSA S.p.A. with registered office in Barberino Val D’Elsa (FI), Italy, Via C. Colombo No. 1, and administrative office in Radicofani (SI) Italy, S.R. Cassia Km. 149.500, with VAT Reg. No. 04494400486, these general conditions of sale regulate sales of the products of STOSA S.p.A.. Therefore, these general conditions of sale must be considered an integral and substantial part of all contracts of STOSA S.p.A., even when orders are placed over the telephone, orally, by fax, e-mail or in another manner, and shall always prevail over any other general or particular conditions of sale prepared by the client.

2.	OBJECT OF THE SUPPLY
2.1	The supply includes only the materials and quantities specified in STOSA’s order confirmation or in other notifications written by STOSA S.p.A. after placing the order. The client is responsible for choosing the products ordered and for using them for its needs and applications.
3.	OFFERS AND ORDERS
3.1	The offers of STOSA S.p.A. are valid for 60 days unless otherwise specified in the offer. Diagrams, illustrations, dimensions, weights and product descriptions, as well as the technical data indicated in them, are provisional in nature; the colours are purely indicative and may not match the actual colour. None of the aforementioned data is therefore binding upon STOSA S.p.A. unless expressly confirmed in writing by the same. Only the order confirmation received from STOSA S.p.A. is binding.
3.2	Orders must be signed by the client and sent to STOSA S.p.A. in writing (fax or e-mail), and will be considered firm until confirmation. Only orders expressly accepted in writing by STOSA S.p.A. are considered confirmed. If STOSA S.p.A. makes changes to an order and confirms it in writing, and the client fails to state in writing that the changes are unacceptable, the changes will be considered tacitly accepted after 3 (three) days from receipt of the confirmation. Any changes or additions to the order will only be valid if they are added by STOSA S.p.A. to the order confirmation

4.	PRICES
4.1	The prices are stated in the order confirmation of STOSA S.p.A..

5.	PAYMENTS
5.1	Unless otherwise agreed in writing, the terms of payment are as follows: 50% upon placing the order and 50% on the date of dispatch of the notice of ready goods. In the case of orders or order confirmations envisaging partial deliveries, the terms of payment specified in the order or order confirmation apply to each partial delivery. Delayed payment, total or partial, by the client will give STOSA S.p.A. the right to terminate the contract with immediate effect and in any case entail the right of STOSA S.p.A. to collect interest at the rate provided by Legislative Decree 231/2002, as amended, as well as compensation for damages.
5.2	In the event of delayed payment by the client, wholly or partially, STOSA S.p.A. has the right to suspend orders and/or partial deliveries in progress, even if related to different supplies and as an exception to the provisions of Art.1460 of the Italian Civil Code, and the client waives its right to compensation for any consequent damage, except in the case of wilful misconduct or gross negligence on the part of STOSA S.p.A.. In no case will the client be allowed to suspend or delay payments, even in the event of a dispute or complaint.

5.3	In the event of delayed payment by the client, wholly or partially, STOSA S.p.A. has the right to suspend orders and/or partial deliveries in progress, even if related to different supplies and as an exception to the provisions of Art.1460 of the Italian Civil Code, and the client waives its right to compensation for any consequent damage, except in the case of wilful misconduct or gross negligence on the part of STOSA S.p.A.. In no case will the client be allowed to suspend or delay payments, even in the event of a dispute or complaint.
-----	---

6.	TERMS OF DELIVERY
6.1	The delivery times indicated in the order confirmation are to be considered merely indicative and not binding. Delivery times vary according to the type of material and workmanship ordered.
6.2	Although STOSA S.p.A. will do everything in its power to deliver the goods within the terms indicated in the order confirmation, in no case will STOSA S.p.A. be liable for damages suffered directly or indirectly by the client, due to delays in the delivery of the goods limited to thirty days from the delivery date indicated in the order confirmation, with the exception of fraud or gross negligence.
6.3	The estimated delivery date is indicated on the order confirmation. The delivery may be extended or suspended in the event the client has not kept up with payments, in accordance with the provisions of Article 5 of these general conditions of sale.

6.4	Should the client request changes to the products after the order confirmation, at its sole discretion STOSA S.p.A. has the option of accepting or refusing the change request; in case of acceptance by STOSA S.p.A., the estimated delivery terms normally indicated will be automatically extended by the time normally required for STOSA S.p.A. to make the requested changes.
-----	---

7.	DELIVERY AND TRANSFER OF RISKS
7.1	Unless otherwise agreed in writing between the parties, delivery of the goods to the Italian territory shall take place under the responsibility and at the expense of STOSA S.p.A.. In any case, transportation does not include unloading the goods, portorage, the tail lift and all the risks of loss or deterioration of the goods connected with such operations, which shall be the sole responsibility of the client. With regard to delivery of the goods to foreign territories, regardless of what is agreed in relation to transport costs and/or terms of payment and/or delivery, the delivery of the goods and the simultaneous transfer of risks are considered ex works (EXW - Incotems 2010), at the factory of STOSA S.p.A. in Radicofani (SI), with the loading of the same onto the means of transport for delivery to the client. Therefore, in the event of delivery delays, damage or loss of the goods during transport, the relevant claims must be addressed to the carrier directly by the client, even if the same has been appointed by STOSA S.p.A.. In any case, transportation does not include unloading the goods, portorage, the tail lift and all the risks of loss or deterioration of the goods, which solely the client will be responsible for from the moment the goods are loaded at the STOSA S.p.A. factory.
7.2	Failure to collect the products, or the unavailability of the client to take delivery of the goods within the term of 15 (fifteen) days from the date of notice of goods ready for delivery by STOSA S.p.A. will give STOSA S.p.A. the right to ask the client to pay a penalty of D 100.00 (one hundred) for each day of storage, save the right to claim compensation for any greater damage. It is understood that from the aforementioned deadline, transfer of risks of the products in storage at the warehouse of STOSA S.p.A. to the client will take place in any case.
7.3	Without prejudice to the provisions of the previous Article 7.1 and unless otherwise agreed in writing between STOSA S.p.A. and the client, the first will take care, at its expense, of transporting the product(s) to the place requested by the client, and bearing any export charges; all customs and tax charges and formalities related to importation in the country of destination, on the other hand, shall be the responsibility of the client.

CONDIZIONI GENERALI DI VENDITA

GENERAL CONDITIONS OF SALE

9.6 Salvo quanto previsto al precedente articolo 9.4, la riparazione o la sostituzione dei prodotti cui siano stati riconosciuti difetti di fabbricazione esaurisce ogni responsabilità di STOSA nei confronti del cliente. Qualsiasi altra forma espressa od implicita di garanzia, così come ogni altra obbligazione o responsabilità di STOSA per danni diretti, indiretti, incidentali o consequenziali, viene espressamente esclusa e rinunciata da parte del cliente, salvo il caso di dolo o colpa grave di STOSA. In particolare, il cliente rinuncia sin d'ora, nella misura massima consentita dalla legge, ad ogni diritto od azione di regresso e/o di chiamata in garanzia per garanzie cui fosse tenuto nei confronti di terzi, in caso di regresso di questi ultimi, sulla base di qualsiasi legge, a causa di difetti o non conformità della merce. In nessun caso sarà concesso al cliente di ridurre il prezzo di vendita dei prodotti per vizi e/o non conformità, salvo consenso scritto di STOSA.

9.7 Poiché è difficile ottenere, anche a causa dell'azione della luce e di altri agenti chimico-fisici, la medesima tonalità di colore in un completamento d'ordine tra la composizione originale e gli elementi aggiuntivi, qualunque sia il lasso di tempo trascorso, il cliente si assume il rischio di ed accetta eventuali differenze cromatiche.

9.8 Resta in ogni caso convenuto che l'eventuale responsabilità di STOSA S.p.A. nei confronti del cliente per vizi e/o difetti e/o difformità e/o danni e/o ritardi nella consegna della merce sarà limitata, salvo quanto previsto al precedente articolo 9.4, al valore della merce venduta al cliente.

10. RESI

Non sono consentiti resi di merce da parte del cliente senza il preventivo assenso scritto di STOSA S.p.A.; in tal caso le spese di spedizione sono a carico del cliente, così come i rischi del trasporto della merce. I resi autorizzati dovranno essere restituiti a STOSA S.p.A. entro 90 giorni dalla data del relativo assenso da parte di quest'ultima.

Non saranno comunque consentiti resi di merce se il materiale sia privo dell'imballo originale.

La causale del documento dovrà essere "reso merce" e tale documento dovrà riportare tutti i riferimenti dell'acquisto originario (numero e data fattura, data di consegna, nome dello spedizioniere).

Qualsiasi reso non conforme alle condizioni sopra descritte verrà automaticamente respinto da STOSA S.p.A.

11. CLAUSOLA RISOLUTIVA ESPRESSA

Ferma restando qualsiasi specifica disposizione sulla cessazione e/o risoluzione del contratto prevista dalla legge applicabile, STOSA S.p.A. avrà diritto di risolvere il contratto con effetto immediato, mediante semplice comunicazione scritta al cliente, in caso si verifichi a carico di quest'ultimo una qualsiasi delle seguenti ipotesi: insolvenza, fallimento, sospensione e/o ritardo dei pagamenti, cessione del patrimonio ai creditori, nomina di un curatore, instaurazione di qualsiasi procedura concorsuale secondo le leggi fallimentari o similari, riduzione delle garanzie, liquidazione o scioglimento, interruzione dell'operatività dell'impresa.

12. SMALTIMENTO DEI RIFIUTI

Sarà onere del cliente provvedere allo smaltimento degli imballi. STOSA S.p.A. ricorda al cliente di non disperdere i mobili e/o i loro imballi nell'ambiente alla fine del loro utilizzo, ma di contattare un'azienda di smaltimento di rifiuti solidi urbani per il loro trasporto in discarica o recupero.

13. LEGGE APPLICABILE E FORO COMPETENTE

13.1 Il contratto tra STOSA S.p.A. e il cliente, ivi inclusa la sua interpretazione e/o esecuzione e/o risoluzione, è regolato dalla legge italiana.

13.2 Ogni controversia tra le parti in relazione all'interpretazione, esecuzione e/o risoluzione del contratto sarà di esclusiva competenza del Foro di Siena, Italia. STOSA S.p.A. avrà, tuttavia, facoltà di adire il Foro del luogo ove il cliente avrà sede.

14. CLAUSOLE GENERALI

Il mancato esercizio di una qualsiasi delle precedenti disposizioni non comporterà rinuncia alla stessa. L'eventuale nullità e/o invalidità di una qualsiasi delle precedenti disposizioni non comporterà nullità e/o invalidità delle altre disposizioni delle condizioni di vendita, salvo che la stessa abbia costituito motivo essenziale e determinante alla sua conclusione.

9.6 Except as provided in the previous art. 9.4, the repair or replacement of products that have been recognised as having manufacturing defects exhausts STOSA's responsibility towards the client. Any other express or implicit form of warranty, as well as any other obligation or responsibility of STOSA for direct, indirect, incidental or consequential damages, is expressly excluded and the client waives its right to make such claims, except in the case of fraud or gross negligence on STOSA's part. In particular, the client as of now waives its right to the maximum extent permitted by law, to the right of recourse and/or call for guarantee for warranties to which it is held towards third parties, in the event of the latter's recourse, on the basis of any law, due to defects or non-conformity of the goods. In no case will the client be allowed to reduce the sale price of the products due to flaws and/or non-conformities, unless consented in writing by STOSA.

9.7 Since in an order completion it is difficult to obtain the same shade of colour of additional elements as the original composition, also due to the action of light and other chemical-physical factors, no matter how little or how much time has passed, the client assumes the risk of colour differences and accepts them.

9.8 It is however agreed that any responsibility of STOSA S.p.A. towards the client for flaws and/or defects and/or discrepancies and/or damage and/or delays in the delivery of the goods is limited, except as provided in the previous art. 9.4, to the value of the goods sold to the client.

10. RETURNS

The client is not permitted to return the goods without the prior written consent of STOSA S.p.A.; in this case the shipping costs are charged to the client, as are the risks of transporting the goods. Authorised returns must be returned to STOSA S.p.A. within 90 days from the date of approval by the latter.

However, returns of goods will not be permitted if the material is not contained in the original packaging.

The reason for the document must be "returned goods" and the document must contain all references of the original purchase (invoice number and date, delivery date, name of the forwarding agent).

Any return that does not meet the conditions described above will be automatically rejected by STOSA S.p.A.

11. TERMINATION CLAUSE

Without prejudice to any specific provision on termination and/or cancellation of the contract envisaged by the applicable law, STOSA S.p.A. has the right to terminate the contract with immediate effect, by providing the client a notice in writing, in the event the client finds himself in any of the following circumstances: insolvency, bankruptcy, suspension and/or delay of payments, transfer of assets to creditors, appointment of a trustee, starting of any insolvency procedure according to bankruptcy or similar laws, reduction of guarantees, liquidation or dissolution, interruption of the company's operations.

12. WASTE DISPOSAL

The client is responsible for disposal of the packaging. STOSA S.p.A. reminds the client not to dispose of the furniture and/or their packaging in the environment if it is no longer to be used, but to contact a company that disposes of solid urban waste for transporting it to landfill or to a recycling facility.

13. APPLICABLE LAW AND PLACE OF JURISDICTION

13.1 The contract between STOSA S.p.A. and the client, including its interpretation and/or execution and/or termination, is governed by Italian law.

13.2 Solely the Court of Siena, Italy, has jurisdiction over any dispute between the parties in relation to the interpretation, execution and/or termination of the contract. STOSA S.p.A. retains the right, however, to go to the Court of the place where the registered office of the client is located.

14. GENERAL CLAUSES

Failure to exercise any of the above provisions will not result in the waiver of the same. The eventual nullity and/or invalidity of any of the previous provisions will not result in the nullity and/or invalidity of the other provisions of the conditions of sale, unless it was the essential and decisive reason for its conclusion.